

# Catalogue 2023

Measuring  
instruments  
and testers



# Measuring and Regulation Equipment Manufacturer

Metrel is an international Group and an expert in the research, development and production of test and measurement equipment. Metrel brand name is worldwide recognized and associated with high quality test and measurement products.

Metrel's instruments provide test and measurement solutions in different maintenance areas including the safety testing of electrical installations and appliances, power quality analysis. In short, our products help to provide information about the safety and functionality of different installations and environments. Through innovative design, electronics and software solutions we provide accurate, reliable and safe to use products.

The company strives to be the leader in advanced technological solutions and therefore invests over 10 % of the yearly turnover into the R&D department.

Our wide range of products is backed up with a complete support package including repair and calibration, technical support and customer training programs. A detailed calibration certificate is supplied as standard with all Metrel products.

## SALES NETWORK

Metrel's products are sold and serviced in over 80 countries by local agents and distributors. Our associated companies are managed by local people who know the special needs of their markets. Sales engineers and specially trained technicians staff give excellent service to our customers.

The GERMAN market is supported by Metrel GmbH based in Eckental ([www.metrel.de](http://www.metrel.de)) and the UK market is supported by Metrel UK based in Epsom Surrey ([www.metrel.co.uk](http://www.metrel.co.uk)). Inquiries for other countries please direct to Metrel d.o.o., the headquarters based in SLOVENIA ([www.metrel.si](http://www.metrel.si)).

## COMMITMENT TO QUALITY

Metrel's quality assurance system is based on BS EN ISO 9001. Through permanent training and education of our employees we strive to increase the efficiency and quality of all our processes. Our commitment to quality is recognized by our customers and is ensured by continuous and extensive research and development of new, accurate, reliable and safe to use products.



## ECOLOGY

Metrel test and measurement equipment complies with the RoHS and WEEE directives. Metrel strives to meet its goals with the most efficient use of resources and the least possible impact on the environment.

## RESEARCH, DEVELOPMENT AND PRODUCTION

The research, development and production of Metrel's products are based in Europe (Slovenia) at Metrel d.o.o. The company strives for total quality control. A dedicated quality assurance department ensures strict adherence to customer specifications. Highly competent R&D engineers provide advanced solutions for our customers.

## TEST LABORATORY

The highly professional test laboratory based in Metrel d.o.o. provides internal services including the testing of components, subassemblies and prototypes of products. This enables Metrel to launch safe and reliable new products into the market. The laboratory provides testing according to the Low Voltage Directive (2006/95/EC) and the EMC Directive (2004/108/EC). The main standards that Metrel also complies to include IEC/EN 61010 and IEC/EN 61326.

## PRODUCTS

Metrel is producing test and measurement equipment that is covering the following fields:

- **Electrical Installations Safety Testing** (IEC/EN 61557, VDE 0413, VDE 0100, BS 7671, HD 60364, CEI 64.8, AS/NZS 3017, AS/NZS3760).
- **Portable Appliances, Machines and Switchgears Safety Testing** (IEC/EN 60204-1, IEC/EN 61439-1, IEC/EN 60335-1, VDE 0701-0702).
- **Testing of Power Distribution Systems and Power Quality Analysis** (EN 50160).
- **Equipment for Laboratories and Schools:** Metrel produces a variety of instruments for electrical testing laboratories and educational purposes. Typical application areas are: electrical workshops, testing labs, research, development and education.

Besides the test and measurement product portfolio offered by Metrel d.o.o. Metrel's daughter company Metrel Mehanika d.o.o. also provide a variety of products focusing on metal processing. Their core business is sheet metal production, milled / turned production, manufacturing of tools and surface protection. For more information please visit [www.metrel-mehanika.si](http://www.metrel-mehanika.si).

## SERVICES

Metrel provides a variety of services relating to training, repair and calibration of test equipment to the highest standards in the industry.

## REPAIR

Metrel provides fast and efficient repair services either directly at Metrel's headquarters service centre or through approved business partners.

## CALIBRATION

The Calibration Laboratory at Metrel DUS is able to calibrate electronic measuring instruments and devices in compliance with the requirements of the ISO/IEC 17025 standard. The laboratory is accredited by Slovenian Accreditation (SA), a member of European Accreditation (EA), signatory of the Multilateral Agreements for the European Co-operation for Accreditation (EA) and International Laboratory Accreditation Co-operation (ILAC) for calibration and testing. The products from the calibration can be issued with an Inspection report and a Calibration

# Contact us

certificate (non accredited). Accredited calibration certificate can also be issued if it is required by the customer.

## TECHNICAL SUPPORT

Metrel provides the following support to its customers and distributors:

- **On-line technical support:** any inquiries related to Metrel products can be sent onto a designated e-mail address:
  - info@metrel.si - GLOBAL market;
  - info@metrel.co.uk - UK market;
  - info@metrel.de - GERMAN market.
- **Technical support line:** the technical support can be obtained also over the phone:
  - +386 (0)1 7558 200 - GLOBAL market;
  - +44 (0) 1924 245 000 - UK market;
  - +49 (0) 9126 28996-0 - GERMAN market.
- **B2B web support:** for Metrel partners a B2B zone enables to obtain technical and marketing information.
- **Download centre:** enables to download files with technical product information. Visit <https://www.metrel.si/en/downloads/>
- **Product finder:** makes it easy for you to find the right product for your application from a wide range of Metrels Test & Measurement products. Visit <https://www.metrel.si/en/shop/>

## TRAINING CENTER

Metrel d.o.o. offers to its customers and distributors:

- **Training on Metrel's instruments:** the product training can be customized on the customer's needs. Metrel can offer training on technical standards, measuring and test methods, use and application of Metrel instruments.
- **Complete distributor setup training:** when establishing a new distributor, Metrel can offer a complete "package" on product training, repair and calibration training and assign in establishing a local calibration and repair department.
- **Training for calibration and repair of Metrel products:** this is help for Metrel's existing and new distributors to enable a high standard of local support to customers who purchase a Metrel product.
- **Bespoke training for larger end users:** in case that a larger customer is requesting training, Metrel can organize the training according to their specific needs. This can be carried out on site or at Metrel's premises.

## GLOBAL MARKET

### Measuring and Regulation Equipment

METREL d.o.o.  
Ljubljanska c. 77  
SI-1354 Horjul  
Tel: +386 (0)1 75 58 200  
E-mail: info@metrel.si  
Web: www.metrel.si



## GERMAN MARKET

### Mess und Prüftechnik

Metrel GmbH  
Orchideenstraße 24  
90542 Eckental  
Tel.: +49 (0) 9126 28996-0  
E-mail: info@metrel.de  
Web: www.metrel.de



## UK MARKET

### Test and Measuring Equipment

Metrel UK Ltd.  
UNIT 16, 1st Qtr Business Park Blenheim Road,  
UK-KT19 9QN Epsom Surrey  
Tel.: +44 (0) 1924 245 000  
E-mail: info@metrel.co.uk  
Web: www.metrel.co.uk



# Instruments Designed with Future in Mind

METREL is one of the world leading manufacturers and distributor of high quality electrical measurement and test instruments, providing the market with innovative solutions on the following segments:

## ELECTRICAL INSTALLATION SAFETY

Metrel offers single and multifunctional electrical installation testers. The instruments are used for initial and periodic testing of domestic and industrial installations, testing of single and multiphase systems and testing of TT, TN, IT and 115 V systems. Metrel meters offer wide selection of functionalities and measurements (depending on the model), can be downloadable or non-downloadable. All meters comply with the European standard IEC/EN 61557.

## HIGH VOLTAGE DIAGNOSTICS

Metrel's high voltage diagnostic equipment (5 ... 10 kV) is used for testing insulation resistance of rotating machinery and cables, production line periodic testing and maintenance, troubleshooting and analysis of all kinds of insulation problems. It gives effective readings in high noise environments such as high voltage substations and switchyards. Some of key features of Metrel's instruments (depends on the model) are PI, DD, DAR testing, R(t) graph plotting, high 5 mA charging current, selectable noise rejection filters, etc.

## PORTABLE APPLIANCE / MACHINE / SWITCHBOARD SAFETY

Metrel's testers can be used in professional PAT testing, general PAT testing, factory / warehouse PAT testing, multi-location PAT testing and after repair safety testing. Metrel's instruments offer a selection of key features for example auto sequencing, automatic testing, Pass / Fail evaluation of results, RCD testing, project uploading, bar-coding system and Pass / Fail barcode label printing, flash test, test of both 230 V appliances and 115 V appliances and many more.

## POWER QUALITY ANALYSIS

The power quality analysers can be widely used for general power quality assessment in distribution and industrial low and middle voltage electric systems (according to IEC 61000-4-30; Class A, Class S), capturing and recording of power supply events, flicker measurement, power factor correction measurements, harmonics measurements, transients recording and over-voltage protection devices performance testing, assessment of UPS, consumption profile recording, etc.

## MULTIMETERS / CLAMP METERS / VOLTAGE TESTERS / THERMAL CAMERAS

The digital multimeters, clamp meters and voltage continuity testers are used for general / basic testing up to high level industrial testing, electronic fault finding, field servicing and heavy duty electrical testing. Some of the key features (depending on the model) are TRMS testing, high accuracy, temperature measurement, lead alert, conductance, PC communication, autocheck function, recording of data, etc.

# Metrel WEB

- General information about our products with quick and practical SEARCH function for product searching.
- Detailed information about our products in extended product specifications.
- Latest information about training and seminars.
- Service information.
- Download centre.
- Product finder.
- Helpdesk, improved with ticketing system.
- Answers to common questions related to our products under Frequent Asked Questions (FAQ) rubric.
- News and information about exhibitions, fairs, meetings and conferences.
- Faster and more sufficient activities in relations with our worldwide distributors (B2B).
- Links to other interesting sites that offers information about occupation safety, metrology, technical heritage, standardization, regulations and technical experience.

## PRODUCT FINDER

Product finder enables filtering of the products with the main filter selectors oriented to, Product Group, Application and Standard, In addition to the main filter selector you can also add additional criterion such as products' Main Features, Additional Features or Special Accessories.

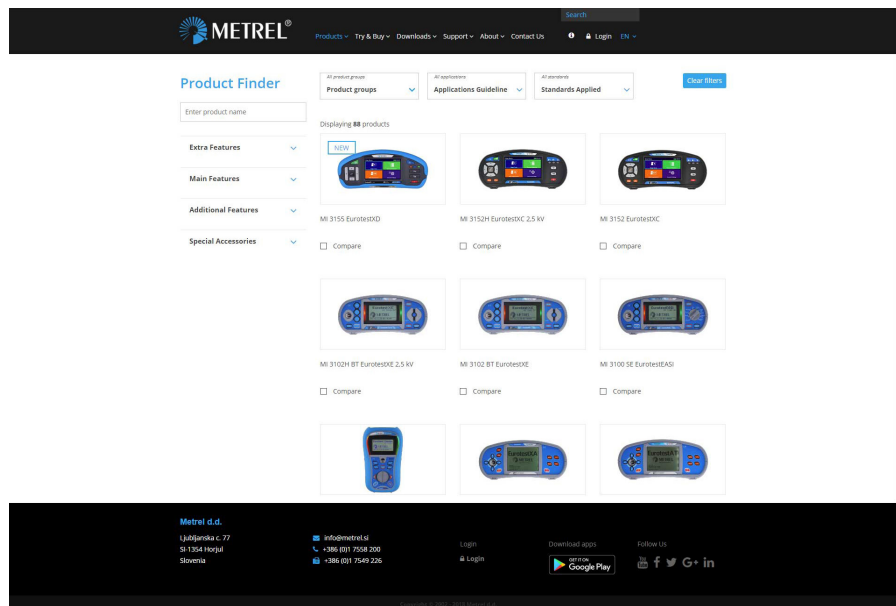

# Content

## Electrical Installation Safety Testing

<b>ELECTRICAL INSTALLATION SAFETY</b>	<b>1.1 - 1.72</b>
High Voltage Insulation / Continuity / Earth / Transformer	2.1 - 2.48
Appliance / Machine / Switchboard Safety	3.1 - 3.52
Power Quality Analysis	4.1 - 4.26
Equipment for laboratories and Schools	5.1 - 5.16
Multimeters / Clamp meters / Voltage testers / Thermal cameras	6.1 - 6.44
Software	7.1 - 7.19
<b>GOOD TO KNOW</b>	
Testing the Safety of Electrical Installation	1.02
<b>MULTIFUNCTIONAL TESTERS</b>	
Selection Guide for Multifunctional Testers	1.06
AUTO SEQUENCE testing	1.08
MI 3155 EurotestXD	1.09
MI 3152 EurotestXC	1.12
MI 3152H EurotestXC 2,5 kV	1.14
MI 3102 BT EurotestXE	1.16
MI 3102H BT EurotestXE 2,5 kV	1.18
MI 3100 SE EurotestEASI	1.20
MI 3125BT EurotestCOMBO	1.22
<b>PHOTOVOLTAIC AND ELECTRICAL INSTALLATIONS TESTER</b>	
Selection Guide for Photovoltaic and Electrical installations Testers	1.25
MI 3108 EurotestPV	1.26
MI 3109 EurotestPV Lite	1.28
<b>SINGLE-FUNCTIONAL TESTERS</b>	
Selection Guide for Single-functional Testers	1.30
MI 3121 Insulation / Continuity	1.32
MI 3122 Z Line-Loop / RCD	1.34
MI 3123 Earth / Clamp	1.36
MI 3110 EurotestIM	1.38
<b>OTHER INSTRUMENTS / ADAPTERS / ACCESSORIES</b>	
MI 3144 Euro Z 800 V	1.40
MI 3143 Euro Z 440 V	1.42
A 1722 PRCD adapter	1.44
MI 3132 EV Tester <b>NEW</b>	1.46
A 1632 eMobility Analyser	1.48
A 1631 EV monitoring cable	1.50
A 1532 EVSE adapter	1.52
A 1532 XA EVSE adapter	1.54
A 1507 3-Phase Active Switch	1.56
MI 2093 Line Tracer	1.58
CS 2099 Eurocheck	1.59
A 1199 Ro - Adapter	1.60
<b>SELECTION GUIDE FOR EIS ACCESSORIES</b>	<b>1.61</b>

# Good to know

## Testing the Safety of Electrical Installation

### Find out more about testing safety of electrical installations

According to European standards requirements electrical installation safety testing includes a combination of following tests:

- Insulation resistance,
- Continuity of protective conductors and equipotential bonding,
- RCD testing,
- Line and fault loop impedance,
- Earth resistance testing (two-wire method without probes, three / four-wire method with two probes, method with current clamp and two probes, method with two current clamps)
- Specific earth resistance,
- Phase sequence, voltage and frequency.

These tests are performed in order to ensure that the requirements are met for the protection of persons, livestock and property against the risk of electric shock and to ensure that the automatic disconnection of the supply is performed correctly.

### Insulation resistance

The insulation is intended to prevent any contact with live parts and withstanding mechanical, chemical, electrical and thermal stresses. Insulation test discloses insulation faults caused by pollution, moisture, deterioration of insulation materials etc. Insulation resistance measurement is covered by the IEC / EN 61557-2 standard.

The power must be switched off and the installation must be disconnected before performing this test to ensure that the test voltage will not be applied to other equipment electrically connected to the circuit to be tested, particularly devices sensitive to voltage surges.

Insulation resistance shall be measured between:

- Line conductors,
- Line and PE conductors,
- Line and Neutral conductors,
- Neutral and PE conductors.

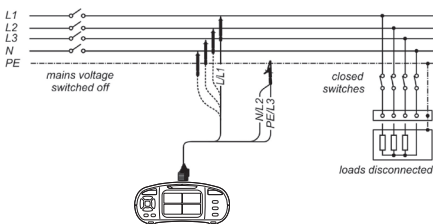

Test circuit for insulation resistance measurement

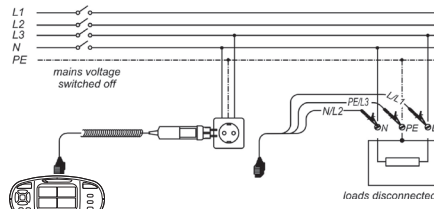

Test circuit for insulation resistance measurement

The insulation resistance test is performed with a DC voltage on a dead system and the resistance must be above the minimum limit set out in the appropriate standards and regulations.

Limit values for electrical installations acc. to IEC 60364-6:

Rated voltage of circuit (V)	DC test voltage (V)	Insulation resistance (M $\Omega$ )
LV secondary switchboard or LV main switchboard	250	$\geq 0.5$
Less than or equal to 500 V including LV main switchboard	500	$\geq 1.0$
Greater	1,000	$\geq 1.0$

*METREL's hint: EurotestXC and EurotestXD have built-in the "Insulation ALL" function which enables performing of 3-port insulation test (L-N, L-PE, N-PE or L1-L2, L1-L3, L2-L3) in one step. This is a very time saving feature especially if measuring insulation on outlets.*

### Continuity of protective conductors and equipotential bonding

The purpose of continuity measurement is to check the continuity of the protective conductors, the main and supplementary equipotential bonds.

The test is carried out using a measurement instrument capable of generating a no-load voltage of 4 to 24 V (DC or AC) with a minimal current of 200 mA.

Continuity test is covered by the EN 61557-4 standard.

The measured resistance must be lower than a threshold specified by the standard applicable to the installation tested, which is usually 2  $\Omega$ . As the resistance value is low, the resistance of the measurement leads must be compensated, particularly if very long leads are used.

*METREL's hint: EurotestXC and EurotestXD can perform the N - PE loop test between instrument's N and PE test terminals. This makes testing with the plug test cable on outlets possible.*

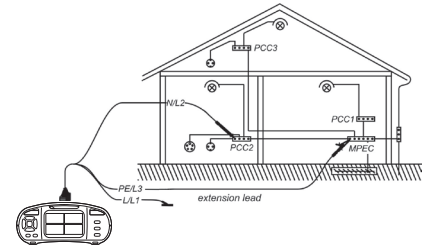

Test circuit for continuity R200 mA measurement

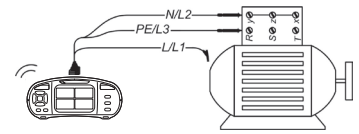

Test circuit for continuous resistance measurement

### RCD testing

RCD devices are used as protection against dangerous fault voltages and fault currents. Various test and measurements are required for verification of RCDs in RCD protected installations. Measurements are based on the EN 61557-6 standard.

Scope of RCD test is:

- to verify effectiveness and proper operation of the RCDs;
- to verify disconnection times and trip out currents of RCDs;
- to verify that there are no or limited present fault currents in the installation.

The following measurements and tests of RCDs can be performed:

- Contact voltage,
- Trip-out time,
- Trip-out current,
- RCD autotest.

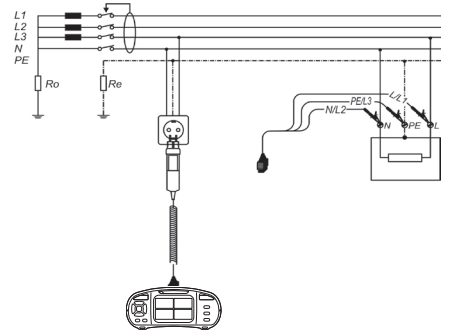

Circuit for testing RCD

*METREL's hint: METREL installation testers have built-in the "RCD AUTO" function which performs RCD testing at x1/2, x1 and x5 current multipliers at both 0° and 180° automatically. With this function all relevant RCD tests can be carried out in one step which is very simple and time saving feature.*

RCD selection table according to their sensitivity:

	AC type	A type	B type
	No response	•	•
	No response	No response	•

### Line impedance

Line impedance is measured in loop comprising of mains voltage source and line wiring (between the line and neutral conductors or between lines on a 3-phase system). It is covered by requirements of the EN 61557-3 standard.

Scope of line impedance test is:

- to verify effectiveness of installed over current devices;
- to verify internal impedance for supplying purpose.

The line-neutral short circuit loop consists of:

- Power transformer secondary impedance  $Z_T$ ,
- $Z_L$  (phase wiring from source to fault),
- $Z_N$  (neutral wiring from source to fault).

The line to neutral impedance is the sum of impedances and resistances that forms the line to neutral loop. In three phase system there are three line-neutral impedances ( $Z_{L1-N}$ ,  $Z_{L2-N}$ ,  $Z_{L3-N}$ ).

$$Z_{LN} = Z_L + Z_N + Z_{TLN}$$

The prospective short circuit current  $I_{PSC}$  is defined as:

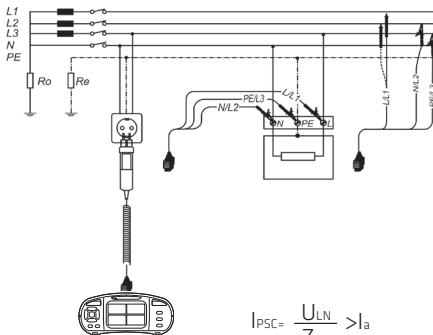

Circuit for measurement of line impedance

$I_{PSC}$  must be higher than current for rated disconnection time of the over current disconnection device. The line - neutral (or line - line) impedance should be low enough e.g. prospective short circuit current high enough that installed protection device will disconnect the short circuit loop within the prescribed time interval.

*METREL's hint: METREL installation testers have built-in tables with fuses and RCDs parameters. When line test is performed, the measured value is automatically compared to the maximum values set out in the standard (EN 61557) and either a PASS or FAIL symbol will appear on the screen to inform the user if the result is within the required limits.*

### Fault loop impedance

Fault loop is a loop comprising mains source, line wiring and PE return path to the mains source. The measurement is covered by requirements of the EN 61557-3 standard.

Scope of loop impedance test is:

- to verify effectiveness of installed over current and / or residual current disconnection devices;
- to verify fault loop impedances, prospective fault currents and fault voltage values.

In TN systems the fault loop  $Z_{LPE}$  consists of:

- $Z_T$  (power transformer secondary impedance);
- $Z_L$  (phase wiring from source to fault);
- $R_{PE}$  (PE / PEN wiring from fault to source).

The fault loop impedance is the sum of impedances and resistances that forms the fault loop.

$$Z_{LPE} = Z_L + R_{PE} + Z_T$$

The prospective fault current  $I_{PSC}$  is defined as:

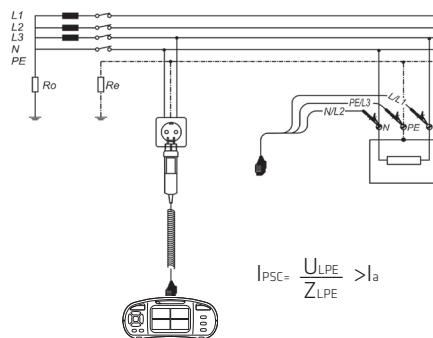

Circuit for measurement of fault loop impedance

*METREL's hint: METREL installation testers have built-in tables with fuses and RCDs parameters. When loop test is performed, the measured value is automatically compared to the maximum values set out in the standard (EN 61557) and either a PASS or FAIL symbol will appear on the screen to inform the user if the result is within the required limits.*

### Earth resistance

Earth resistance testing is used on TN, TT and IT systems to ensure that the resistance of the earth electrode is sufficiently low so that, in the case of a fault, a dangerous voltage does not appear on any parts of the installation or on any appliances which have a connection to earth.

The measurement conforms to the EN 61557-6 standard.

Scope of earth resistance test is:

- Earthing of exposed conductive parts assures that the voltage on them stays below dangerous level in case of a fault.

In TN installations the earthing is realized at the source and / or distribution points that's why the earthing resistances are usually very low (below 1Ω).

TT installations have their own main earthing. The resistances are usually higher than in TN systems (from few Ω up to several hundred Ω). Because of this dangerous fault voltages and body currents can occur at relatively low fault currents. Therefore TT systems usually have additional RCD protection.

The following earth resistance measuring methods are available:

- Standard 3-wire (4-wire) method for standard resistance to earth measurements;
- 3-wire (4-wire) method with one clamp, for measuring resistance to earth of individual earthing rods;
- Two clamps method for measuring resistance to earth of individual earthing rods (recommended in IEC 60364-6 for urban areas);
- Specific earth resistance (is carried out in order to assure more accurate calculation of earthing systems e.g. for high-voltage distribution columns, large industrial plants, lightning systems etc.).

**Connection diagrams:**

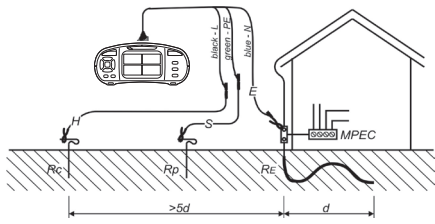

Circuits for three-wire measurement

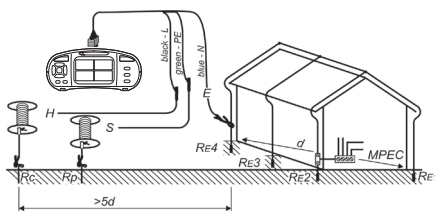

Circuits for three-wire measurement

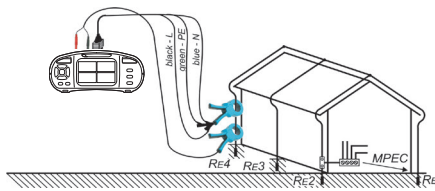

Circuit for two clamps measurement

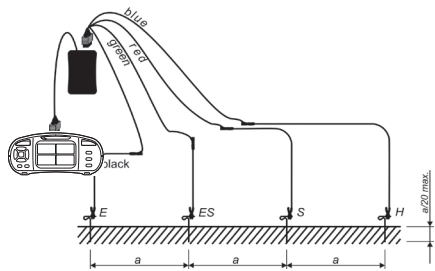

Circuit for measurement of specific earth resistance

Recommended earth resistance measuring methods:

**TN system**

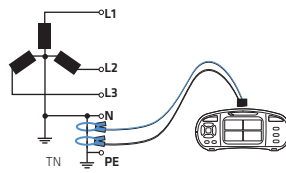

Two clamps method (clamps around main N/PE cable).

**TT system**

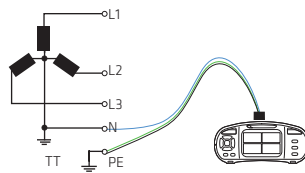

Two-wire method (test from the socket between N and PE)

**IT system**

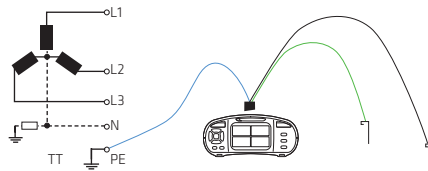

Three-wire method (test leads to auxiliary rods in triangle)

**Lightning conductor**

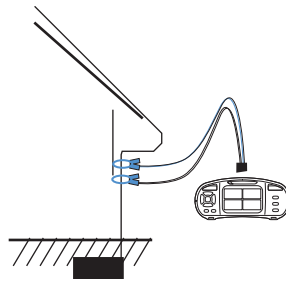

Two clamps method

Limits:

- 2 Ω - above ground,
- 10 Ω - complete system,
- 20 Ω - individual electrode or 8% of specific earth resistance.

**Phase sequence, voltage and frequency**

Phase sequence test is used for determining of line voltages order in 3-phase systems. This order defines direction of rotation of motors and generators.

Phase sequence measurement conforms to the EN 61557-7 standard.

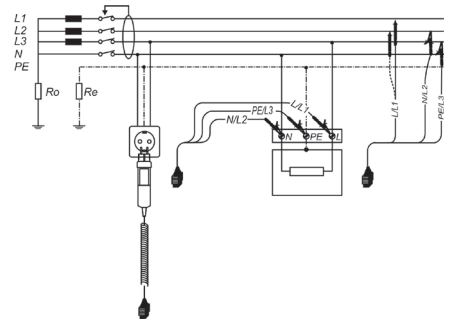

Circuit for voltage measurements

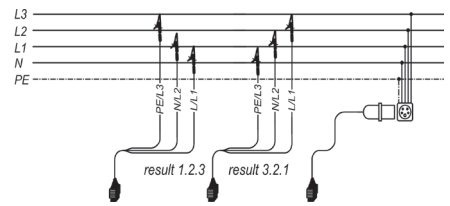

Circuit for voltage measurement, frequency and phase sequence

*METREL's hint: METREL installation testers have on-line voltage monitor which in all functions displays on one screen voltages between L to PE, L to N and N to PE (single phase system) or L1 to L2, L2 to L3 and L1 to L3 (3-phase system). This feature allows quickly identify incorrect connections, disconnected wires or incorrect voltages.*

**PE test terminal**

A very dangerous situation can occur in case dangerous voltage is applied to the PE wire or other accessible metal parts. A common reason for this fault is incorrect wiring. Metrel's instruments are equipped with touchable PE electrode (TEST key). When touching TEST key in all functions that require mains supply the user automatically performs test for the presence of phase voltage at the PE protection terminal.

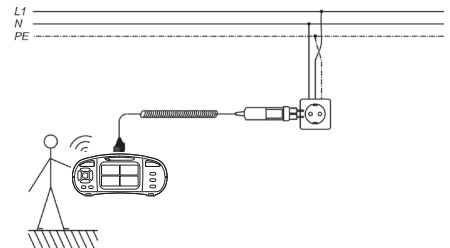

Example for application of PE test terminal



The overvoltage category specifies the highest mains voltage (or lightning strike, short circuit due to incorrect use, etc.) that the instrument can withstand without danger for the tester or for the object being measured. The standard specifies four overvoltage categories. The overvoltage category affects component sizing via the air gap. The higher the category, the bigger is the distance to the power source.

**CAT I** - electronic devices, signal level.

**CAT II** - domestic appliances, portable appliances, single-phase loads, sockets, (>10 m from CAT III; >20 m from CAT IV).

**CAT III** - three-phase distribution systems, lighting systems in large buildings, distribution panels.

**CAT IV** - three-phase systems on power stations, electricity meters, outdoor installations and supply cable incoming feed.

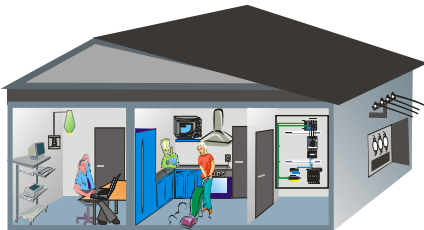

CAT I      CAT II      CAT III      CAT IV

- is the installation single- or three-phase;
  - is the RCD present in the installation.
- To simplify the selection of the appropriate test sequence the detailed flow chart is supplied with the instrument.

After choosing the AUTO SEQUENCE® and setting the limits the user just has to press TEST button and the sequence will automatically perform all predefined tests. When the sequence is finished, the

instrument will display overall PASS / FAIL decision. All the results can be saved to the structured instrument's memory at once for further data verification and automatic generation of test report with the help of the PC SW MESM.

The revolutionary AUTO SEQUENCE® procedure allows performing testing up to 5 times faster in comparison with conventional methods.

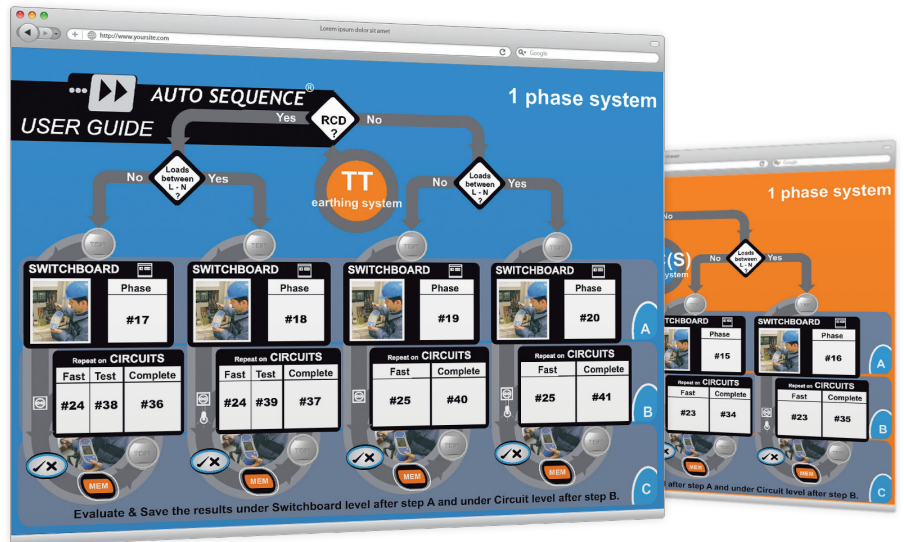

**AUTO SEQUENCE®**

is a unique patented by Metrel testing procedure which allows performing of series of requested installation tests with a single press of TEST button. The results of each test are automatically compared to pre-set limits and PASS / FAIL evaluated.

While ensuring efficient, fast and easy way of installation safety testing AUTO SEQUENCE® guarantees absolute safety of operator due to automatic detection of possible irregular installation conditions.

Definite number of test sequences is already stored in the instrument. Besides, user can program and store custom test sequences.

The user can choose appropriate pre-programmed AUTO SEQUENCE® procedure according to following criterions:

- which part of electrical installation will be tested;
- which earthing system is implemented (TN, TT or IT);



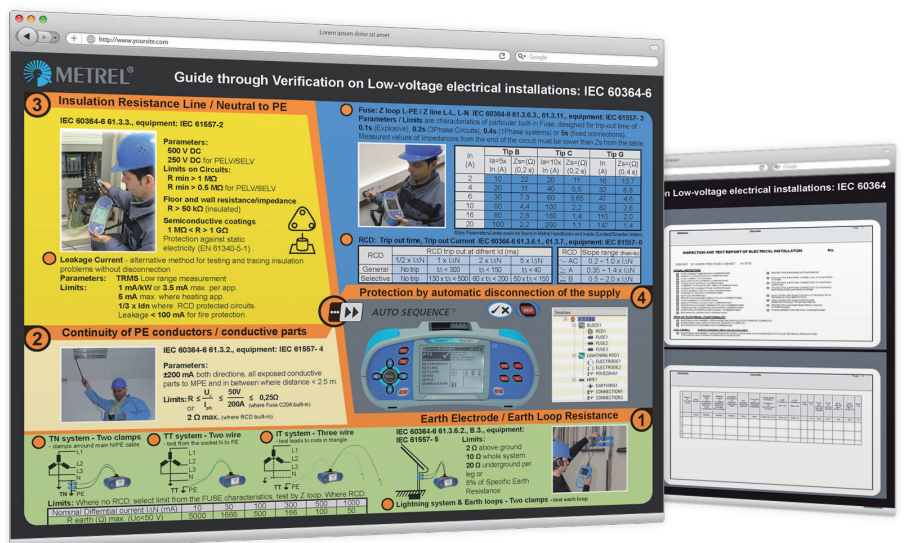

**Guide through Verification on Low-voltage electrical installations: IEC 60364-6**



# Multifunctional installation testers

## Selection Guide for Multifunctional Testers

FEATURES	Description	MI 3155 EurotestXD
		
<b>INSULATION</b>	Insulation resistance	•
	Test voltage (VDC)	50 ... 2500
	Autotest insulation L-PE, N-PE, L-N	•
	Diagnostic test (PI, DAR calculation)	•
<b>CONTINUITY AND LOW RESISTANCE MEASUREMENT</b>	Continuity of PE conductors with automatic polarity change, test current 200 mA	•
	Low resistance measurement (continuous measurement), test current 7 mA	•
<b>LINE / LOOP IMPEDANCE</b>	Line impedance with Ipsc calculation	•
	4 wire Line impedance with Ipsc calculation	•
	Loop impedance with Ipsc calculation	•
	4 wire Loop impedance with Ipsc calculation	•
	RCD Trip Lock loop impedance	•
	Built-in fuse tables for PASS / FAIL evaluation	•
<b>RCD TESTING</b>	Contact voltage measurement without RCD tripping	•
	RCD trip-out time	•
	RCD trip-out current with rising test current	•
	Automatic testing of RCDs	•
	RCD type (general and selective)	AC / A / B / F / B+
	MI RCD, EV RCD / PRCD-S, PRCD-K	• / •
<b>VOLTAGE, FREQUENCY</b>	AC voltage measurement	•
	Online voltage monitor	•
	Frequency measurement	•
<b>PHASE SEQUENCE</b>	L1 - L2 - L3	•
<b>EARTH MEASUREMENTS</b>	Earth resistance 3-(4-)wire method	•
	Earth resistance 3-(4-)wire method with additional current clamp	Option
	Earth resistance measurement with 2 current clamps	Option
	Specific earth resistance	Option
<b>AUTO SEQUENCE</b>	Programmable AUTO SEQUENCES	•
	Pre-programmed AUTO SEQUENCES	•
	Predefined mini AUTO TESTS	•
<b>OTHER MEASUREMENTS</b>	TRMS leakage / load current	Option
	Illuminance measurement	Option
	Varistor test	•
	Fuse / fault locator	•
	High resolution loop impedance (mΩ)	Option
	EVSE adapter	Option
	Insulation Monitoring Devices (IMD) testing (IT systems)	•
	First fault leakage current (ISFL) measurement (IT systems)	•
<b>OTHER FEATURES</b>	Nominal frequency range	14 ... 500 Hz
	PASS / FAIL evaluation of test results	•
	IT earthing mode systems support	•
	Touch electrode	•
	HELP menu	•
<b>COMMUNICATION PORTS &amp; PC FEATURES</b>	RS232 / USB / Bluetooth	• / • / •
	Work space manager	•
	Memory /SD card	8 GB
	Colour touch screen	•
<b>MEMORY SOFTWARE</b>	MESM / EuroLink PRO	• / -
	Professional PC SW	•
	Advanced PC SW	Option
<b>GENERAL DATA</b>	Safety category	CAT III / 600 V CAT IV / 300 V
	IP protection	IP 56
	Batteries	4.4 Ah Li-Ion
	Built-in battery charger	•
	Weight (kg)	1.78
	Dimensions (mm)	252 x 111 x 165

MI 3152 EurotestXC	MI 3152H EurotestXC 2,5 kV	MI 3102 BT EurotestXE	MI 3102H BT EurotestXE 2.5kV	MI 3100 SE EurotestEASI	MI 3125 BT EurotestCOMBO
					
•	•	•	•	•	•
50 ... 1000	50 ... 2500	50 ... 1000	50 ... 2500	50 ... 1000	50 ... 1000
	•		•		
•	•	•	•	•	•
•	•	•	•	•	•
•	•	•	•	•	•
•	•	•	•	•	•
•	•	•	•	•	•
•	•	•	•	•	•
•	•	•	•	•	•
•	•	•	•	•	•
•	•	•	•	•	•
•	•	•	•	•	•
AC / A / B / F / B+	AC / A / F	AC / A / B / F / B+	AC / A / F	AC / A / F	AC / A / B / F / B+
• / •	• / •	• / •			• / -
•	•	•	•	•	•
•	•	•	•	•	•
•	•	•	•	•	•
•	•	•	•	•	•
Option					
Option	Option	Option	Option		
Option	Option				
•	•				
•	•	•	•	•	
Option	Option	Option	Option		
Option	Option	Option	Option		
Option	Option				
Option	Option	Option	Option	Option	Option
•		•			
•		•			
14 ... 500 Hz	14 ... 500 Hz	45 ... 65 Hz	45 ... 65 Hz	45 ... 65 Hz	45 ... 65 Hz
•	•	•	•	•	•
•	•	•	•	•	•
•	•	•	•	•	•
•	•	•	•	•	•
• / • / •	• / • / •	• / • / •	• / • / •	• / • / Option	• / • / •
•	•				
8 GB	8 GB	4 / 1800	4 / 1800	4 / 1800	4 / 1700
•	•				
• / -	• / -	• / •	• / •	• / •	• / •
•	•	•	•	•	•
Option	Option	Option	Option	Option	Option
CAT III / 600 V	CAT III / 600 V	CAT III / 600 V	CAT III / 600 V	CAT III / 600 V	CAT III / 600 V
CAT IV / 300 V	CAT IV / 300 V	CAT IV / 300 V	CAT IV / 300 V	CAT IV / 300 V	CAT IV / 300 V
IP 40	IP 40	IP 40	IP 40	IP 40	IP 40
6 x AA	6 x AA	6 x AA	6 x AA	6 x AA	6 x AA
•	•	•	•	•	•
1.37	1.37	1.31	1.31	1.31	1.0
230 x 103 x 115	230 x 103 x 115	230 x 103 x 115	230 x 103 x 115	230 x 103 x 115	140 x 80 x 230

# Multifunctional installation testers

## AUTO SEQUENCE testing

AUTO SEQUENCE® testing is a way of testing introduced in Metrel's testers over a decade ago and now re-introduced with new generation testers. AUTO SEQUENCES not only simplify the measuring procedure, but also minimizes human error when performing measurements. This way a series of user-defined single tests is done with a push of a single button. Depending on the instrument model the user can create AUTO SEQUENCES in PC SW MESM and upload them from a PC to the device or download them from the device for editing and sharing.

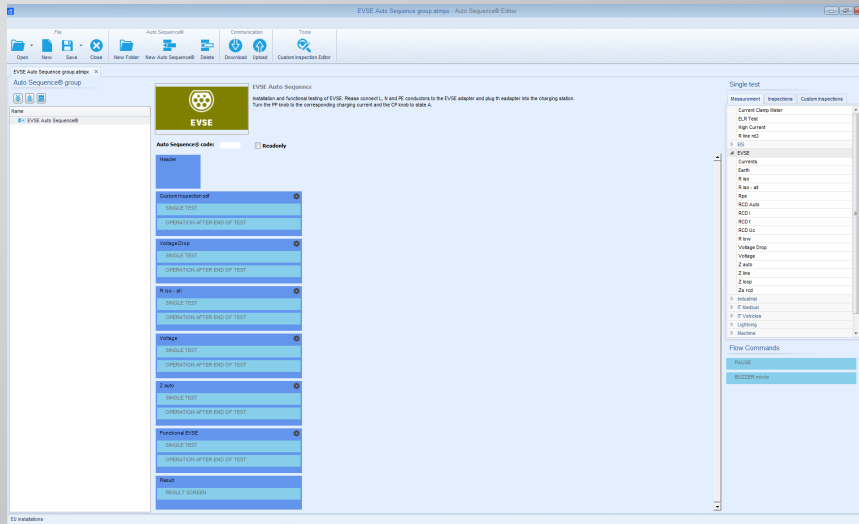

AUTO SEQUENCES can be prepared and/or edited in PC SW MESM and later uploaded to any device. The device will only perform supported measurements.

- Supported devices are:
- MI 3155 EurotestXD
  - MI 3152 EurotestXC (no AUTO SEQUENCE® upload possible)
  - MI 3152 H EurotestXC 2.5 kV (no AUTO SEQUENCES upload possible)
  - MI 3280 Digital Transformer Analyser
  - MI 3281 WR Analyser
  - MI 3288 Earth Insulation Tester
  - MI 3290 Earth Analyser
  - MI 3360 OmegaGT XA
  - MI 3394 CE MultiTesterXA
  - MI 3325 MultiServicerXD
  - MI 6601 MediTest

AUTO SEQUENCES may be run independently or through a pre-prepared structure in the memory organizer.

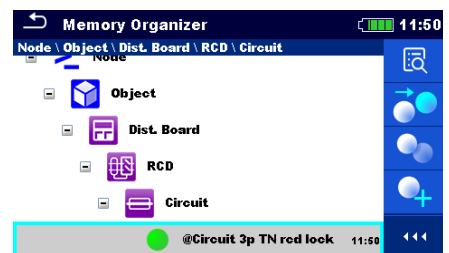
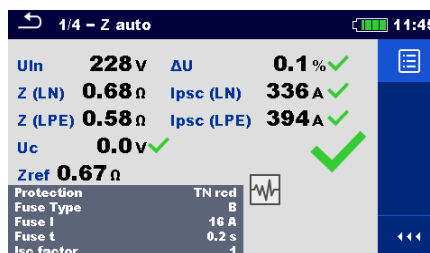
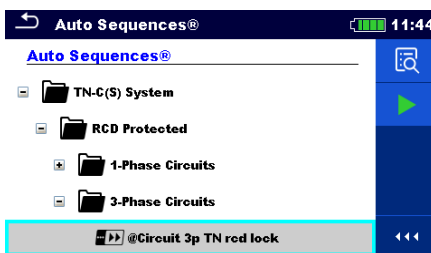
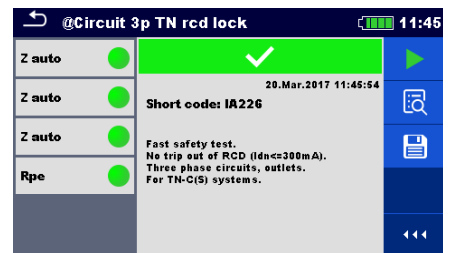
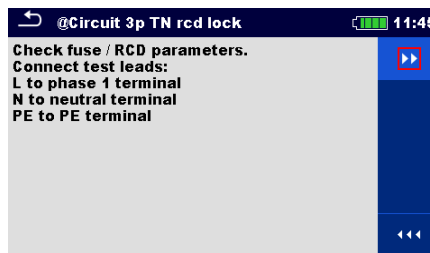
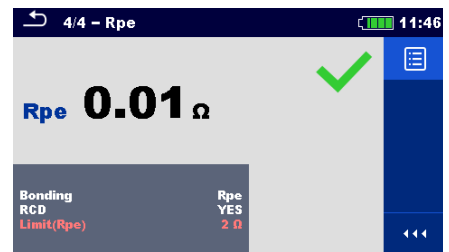
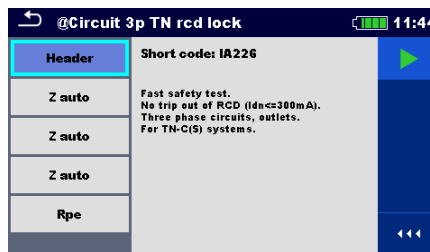

# Multifunctional installation testers

## MI 3155 EurotestXD

MI 3155 EurotestXD is the newest flagship of Metrel's most advanced line of multifunctional measuring instruments and is designed specifically for testing in industry. What differentiates this instrument from the rest is its ergonomic design and an intuitive user interface, encompassing a memory organizer and fully programmable AUTO SEQUENCES, managed through a large colour touch screen display. It is fully compliant with functionality standards (e.g. IEC/EN 61557) and other reference standards for testing (e.g. IEC/EN/HD 60364-4-41,...) as is required for any instrument that performs TRMS current measurements, RCD tests, line and loop impedance tests with 3 (and 4) wires and earth resistance measurements. Besides those, the instrument supports a wide range of tests and measuring functions, including on-line voltage monitoring, phase sequence testing, varistor testing, PI/DAR calculation, luminance measurement, discharge time testing, ISFL measurements, IMD tests as well as functional and visual inspections.



### MEASURING FUNCTIONS

- **Live Transformer's Impedance Measurement with Four Wire Test;**
- Hi-precision Short Circuit Current evaluation with Calculated Hot factor;
- **3-wire test of PE** (RPE function) without extension lead conductor;
- **Autotest insulation function between L-N, N-PE and L-PE** (R ISO ALL function);
- **4 wire continuity test;**
- Insulation resistance with **DC voltage from 50 V to 2500 V** and **PI, DAR calculation;**
- **Varistor test;**
- Continuity of PE conductors with 200 mA DC test current with polarity change;
- Continuity of PE conductors with 7 mA test current without RCD tripping;
- **3-wire and 4-wire wire loop impedance** (LPE) measurement with Trip Lock (EV) RCD function;
- **Touch voltage / Contact voltage** measurement with **external P/S probe.**
- **2-wire and 3-wire line impedance (L-L, L-N)** measurement;
- **1-phase / 3-phase TRMS voltage** and frequency measurements;
- **Line, loop and RCD** measurements at frequency range **16 ... 400 Hz;**
- Phase sequence;
- Power and THD measurement (up to the 12<sup>th</sup> harmonic);

- RCD testing (general and selective, type AC, A, F, B, B+, **MI RCD, EV RCD, EV RCM, PRCD, PRCD-K, PRCD-S**);
- Earth resistance (3-wire and 2-clamps method);
- Specific earth resistance with Ro-adaptor (option);
- TRMS leakage and load currents (option);
- First fault leakage current (ISFL);
- Testing of Insulation Monitoring Devices (IMDs);
- **Machine mode support** with time discharge;
- Illumination (option);
- High resolution Loop impedance (mΩ) (option);
- **EVSE** (Electrical Vehicle Supply Equipment) **support** (option);
- Determining location of cables (option);
- QR and/or barcode scanner support (option).

### KEY FEATURES

- **Programmable AUTO SEQUENCES.\***
- **Predefined profile dependent AUTO SEQUENCES.**
- Predefined **Automatic tests:**  
Auto TT (U, ZIn, Zs, Uc);  
Auto TN/RCD (U, ZIn, Zs, Rpe);  
Auto TN (U, ZIn, Zlpe, Rpe);  
Auto IT (U, ZIn, Isc, Isfl, IMD).
- **High resolution colour touch screen, 4.3" TFT**
- **Functional inspections.**

- **Visual inspections.**
- **Custom inspections** (visual and functional) which may be incorporated into AUTO SEQUENCES.
- **EVSE AUTO SEQUENCES and function inspections.**
- **Machine functional and visual inspections.**
- **Built-in help screens** for referencing on site.
- **Built-in fuse tables** for automatic evaluation of the line / loop impedance result.
- **Monitoring of all 3 voltages** in real-time.
- **Automatic polarity reversal** on continuity test.
- **Automated RCD testing procedure (RCD AUTO).**
- **Automated Impedance testing procedure (Z AUTO).**
- **Measurement filtering according to the selected area group.**
- **Built-in charger** and rechargeable batteries as standard accessory.
- **BT communication with PC, Android tablets and smart phones** via built-in BT.
- **PC SW Metrel ES Manager** (structure and report creation, data upload/download). \*
- **Optional aMESM Android app** (structure and report creation, data upload/download). \*\*

\* Available with MESM PRO licence

\*\* Available with EU Set

## TECHNICAL DATA

Function		Measuring range	Resolution	Accuracy
CONTINUITY	Test Current 7 mA 2-wire	0.00 Ω ... 19.99 Ω	0.1 Ω	±(5 % of r. + 3 digits)
		20.0 Ω ... 1999 Ω	1 Ω	
	Test Current 200 mA 2-wire	0.00 Ω ... 19.99 Ω	0.01 Ω	±(3 % of r. + 3 digits)
20.0 Ω ... 199.9 Ω		0.1 Ω	±(5 % of r.)	
200.0 Ω ... 1999 Ω		1 Ω	±(5 % of r.)	
Test Current 200 mA 4-wire	0.000 Ω ... 00.049 Ω	0.001 Ω	±(30 digits)	
	0.050 Ω ... 19.999 Ω	0.001 Ω	±(3 % of r. + 10 digits)	
	20.0 Ω ... 199.9 Ω	0.01 Ω	±(5 % of r.)	
	200.0 Ω ... 1999 Ω	0.1 Ω	±(5 % of r.)	
INSULATION RESISTANCE	R iso, R iso all <sup>1</sup> Test Voltage 50/100/250 V	0.00 MΩ ... 19.99 MΩ	0.01 MΩ	±(5 % of r. + 3 digits)
		20.0 MΩ ... 99.9 MΩ	0.1 MΩ	±(10 % of r.)
		100.0 MΩ ... 199.9 MΩ	0.1 MΩ	±(20 % of r.)
	R iso, R iso all <sup>1</sup> Test Voltage 500/1000 V	0.00 MΩ ... 19.99 MΩ	0.01 MΩ	±(5 % of r. + 3 digits)
		20.0 MΩ ... 199.9 MΩ	0.1 MΩ	±(5 % of r.)
	200 MΩ ... 999 MΩ	1 MΩ	±(10 % of r.)	
R iso, R iso all <sup>1</sup> Test Voltage 2500 V	0.00 MΩ ... 19.99 MΩ	0.01 MΩ	±(5 % of r. + 3 digits)	
	20.0 MΩ ... 199.9 MΩ	0.1 MΩ	±(5 % of r.)	
	200 MΩ ... 999 MΩ	1 MΩ	±(10 % of r.)	
DAR, PI	1.00 GΩ ... 19.99 GΩ	0.01 GΩ	±(10 % of r.)	
	0.01 ... 9.99	0.01	±(5 % of r. + 2 digits)	
Varistor test AC, DC <sup>2</sup>	10.0 ... 100.0	0.1	±(5 % of r.)	
	0 V ... 1000 V (DC) 0 V ... 625 V (AC)	1 V	±(3 % of r. + 3 digits)	
RCD	RCD Uc	0.00 V ... 19.99 V	0.1 V	(-0 %/+15 %) of r. ± 10 digits
		20.0 V ... 99.9 V		(-0 %/+15 %) of r.
	RCD (t),	0.00 ms ... 40.0 ms	0.1 ms	±1 ms
	0.0 ms ... max. time		±3 ms	
RCD I Ramp	0.2xIΔN ... 1.1xIΔN (AC, MI, EV a.c.)	0.05xIΔN	±0.1xIΔN	
	0.2xIΔN ... 1.5xIΔN (A, IΔN ≥30 mA)			
	0.2xIΔN ... 2.2xIΔN (A, IΔN <30 mA)			
	0.2xIΔN ... 2.2xIΔN (B, MI, EV d.c.)			
IMPEDANCE	Zline (L-L, L-N), Ipsc, Zline 4-wire <sup>3</sup>	0.00 Ω ... 9.99 Ω	0.01 Ω	±(3 % of r. + 3 digits)
		10.0 Ω ... 99.9 Ω	0.1 Ω	±(10 % of r.)
		100 Ω ... 999 Ω	1 Ω	
		1.00 kΩ ... 9.99 kΩ	10 Ω	
	Zloop (L-PE), Ipf, Zloop 4-wire <sup>3</sup>	0.00 Ω ... 9.99 Ω	0.01 Ω	±(3 % of r. + 3 digits)
		10.0 Ω ... 99.9 Ω	0.1 Ω	±(10 % of r.)
100 Ω ... 999 Ω	1 Ω			
Zs RCD <sup>4</sup>	1.00 kΩ ... 9.99 kΩ	10 Ω		
VOLTAGE	TRMS (0, 14 ... 500 Hz)	0 ... 550 V	1 V	±(2 % of r. + 2 digits)
	Frequency	0.00 Hz ... 9.99 Hz	0.01 Hz	±(0.2 % of r. + 1 digits)
	10.0 Hz ... 499.9 Hz	0.1 Hz		
CURRENT	TRMS, AC with A 1018, range=20 A	0.0 mA ... 99.9 mA	0.1 mA	±(5 % of r. + 5 digits)
		100 mA ... 999 mA	1 mA	±(3 % of r. + 3 digits)
		1.00 A ... 19.99 A	0.01 A	±(3 % of r.)
	TRMS, AC/DC with A 1391, range=40 A	0.00 A ... 1.99 A	0.01 A	±(3 % of r. + 3 digits)
		2.00 A ... 19.99 A	0.01 A	±(3 % of r.)
	20.0 A ... 39.9 A	0.1 A	±(3 % of r.)	
TRMS, AC/DC with A 1391, range = 300 A	0.00 A ... 19.99 A	0.01 A	Indicative	
	20.0 A ... 39.9 A	0.1 A	Indicative	
40.0 A ... 299.9 A	0.1 A	±(3 % of r. + 5 digits)		
EARTH RESISTANCE	3 wire <sup>5</sup>	0.00 Ω ... 19.99 Ω	0.01 Ω	±(5 % of r. + 5 digits)
		20.0 Ω ... 199.9 Ω	0.1 Ω	
		200.0 Ω ... 9999 Ω	1 Ω	
	2 clamp	0.00 Ω ... 19.99 Ω	0.01 Ω	±(10 % of r. + 10 digits)
		20.0 Ω ... 30.0 Ω	0.1 Ω	±(20 % of r.)
		30.1 Ω ... 39.9 Ω	0.1 Ω	±(30 % of r.)
Specific earth resistance	0.0 Ωm ... 99.9 Ωm	0.1 Ωm	±(5 % of r.) for Re 1 Ω ... 1999kΩ	
	100 Ωm ... 999 Ωm	1 Ωm		
	1.00 kΩm ... 9.99 kΩm	0.01 kΩm		±(10 % of r.) for Re 2 kΩ ...
	10.0 kΩm ... 99.9 kΩm	0.1 kΩm		19.99kΩ
	100 kΩm ... 9999 kΩm	1 kΩm		±(20 % of r.) for Re > 20 kΩ
POWER	Power (P, S, Q)	0.00 W (VA, Var) ... 99.9 kW (kVA, kVar)		
	Power factor	-1.00 ... 1.00		
	Voltage THD	0.1 % ... 99.9 %		
HARMONICS	Voltage harmonics	0.1 V ... 500 V		
	Voltage THD	0.1 % ... 99.9 %		
	Current harmonics and Current THD	0.00 A ... 199.9 A		
FIRST FAULT LEAKAGE CURRENT (ISFL)	Isc 1, Isc 2	0.0 mA ... 19.9 mA	0.1 mA	±(5 % of r. + 3 digits)

Function		Measuring range	Resolution	Accuracy
IMD TEST	Threshold indicative insulation resistance	5 ... 640 kΩ	5 kΩ	Indicative values, up to 128 steps
ILLUMINANCE	Type B	0.01 lux ... 19.99 lux	0.01 lux	±(5 % of r. + 2 digits)
		20.0 lux ... 199.9 lux	0.1 lux	
		200 lux ... 1999 lux	1 lux	±(5 % of r.)
		2.00 klux ... 19.99 klux	10 lux	
	Type C	0.01 lux ... 19.99 lux	0.01 lux	±(10 % of r. + 3 digits)
		20.0 lux ... 199.9 lux	0.1 lux	
DISCHARGING TIME	Discharging time	200 lux ... 1999 lux	1 lux	±(10 % of r.)
		2.00 klux ... 19.99 klux	10 lux	
	Peak voltage	0.0 s ... 10.0 s	0.1 s	±(5 % of r. + 2 digits)
	Power supply	0 V ... 550 V	1 V	±(5 % of r. + 3 digits)
	Overvoltage category	7.2 V (4400 mAh Li-Ion battery pack)		
GENERAL	Protection class	600 V CAT III; 300 V CAT IV		
	COM port	double insulation		
	Display	BT, USB, RS232		
	Weight	Colour TFT display, 4.3 inch, 480 x 272 pixels		
	Dimensions	1.78 kg		
		252 x 111 x 165 mm		

<sup>1</sup> Measuring current 1 mA ... 3 mA

<sup>2</sup> Threshold current 1 mA

<sup>3</sup> I<sub>test</sub> = 20 A @ 230 V; 16 ... 400 Hz

<sup>4</sup> I<sub>test MAX</sub> = 0.5 x I<sub>ΔN</sub>

<sup>5</sup> U<sub>oc</sub> < 30 V<sub>AC</sub>, I<sub>sc</sub> < 30 mA, f = 125 Hz

## STANDARDS

### Functionality:

- EN 61557;
- DIN 5032

### Other reference standards for testing:

- IEC/EN/HD 60364-4-41;
- IEC/EN 61008;
- IEC/EN 61009;
- **IEC 62572;**
- **EN 62955;**
- BS 7671;
- AS/NZ 3017

### Electromagnetic compatibility (EMC):

- IEC/EN 61326-1

### Safety:

- IEC/EN 61010-1;
- IEC/EN 61010-031;
- IEC/EN 61010-2-030;
- IEC/EN 61010-2-032

## STANDARD SET

### MI 3155 ST

- Instrument MI 3155 EurotestXD
- 4400 mAh battery pack
- Power supply adapter 12 V / 3 A
- Plug commander, 1.5 m
- Test lead, 4-wire, 1.5 m
- Test lead, 3-wire, 1.5 m
- Test lead, 2-wire, 2.5 kV, 1.5 m
- Test probe, 4 pcs (black, blue, green, red)
- Crocodile clip, 6 pcs (black - 2 pcs, blue - 1 piece, green - 1 piece, red - 2 pcs)
- Earth set 20 m
- USB cable
- Soft carrying bag
- Soft carrying neck belt
- Metrel ES Manager BASIC Licence\*

## APPLICATION

- Testing of TT, TN and IT systems;
- Testing of single and multiphase systems;
- Initial and periodic testing of domestic and industrial installations;
- LV Installation safety testing;
- Maintenance;
- Lightning installations;
- Testing on high and low frequency installations (industrial, aircraft, railway, mining, chemistry, ferry boat);
- Construction sites;
- Mobile LV Generator Units;
- Machine and switchboard testing;
- Medical installation testing;
- Fire brigades, ambulance, military and police vehicles;
- Mobile Video/Audio, Concert Halls, Fairs, Playgrounds;
- Electrical Vehicle Supply Equipment (EVSE) testing;
- Observation of insulation trends.

- Short instruction manual
- Instruction manual (CD)
- Guide for testing and verification of Low voltage installations (CD)
- Calibration certificate
- Metrel ES Manager (program installation) A 1481 (CD)

### MI 3155 EU

- MI 3155 ST
- 8800 mAh battery pack instead of 4400 mAh battery pack
- Current clamp A 1018 (low range, leakage)
- Current clamp A 1019
- Metrel ES Manager PRO Licence\*
- Metrel aMESM Android app

\*Metrel ES Manager can be downloaded free of charge from Metrel Web server.



Picture of MI 3155 EU set

# Multifunctional installation testers

## MI 3152 EurotestXC



MI 3152 EurotestXC is an instrument from the new generation of Metrel's multifunctional measuring instruments. The already well known functions like complete installation safety testing according to IEC/EN 61557 and AUTO SEQUENCE testing of TN, TT and IT earthing systems are managed by a completely new user interface based on large colour touch screen display. A wide range of functions is included: from on-line voltage monitoring, phase sequence testing, varistor testing, earth resistance measurement, illuminance measurement and TRMS current measurement up to RCD tests, line and loop impedance tests, specific earth resistance measurements as well as ISFL measurements and the IMD tests.

### MEASURING FUNCTIONS

- Insulation resistance with DC voltage from 50 V to 1000 V;
- **Varistor test**;
- Continuity of PE conductors with 200 mA DC test current with polarity change;
- Continuity of PE conductors with 7 mA test current without RCD tripping;
- Line/Loop impedance combined also in one function **Z AUTO**;
- Loop impedance with Trip Lock (EV) RCD function;
- TRMS voltage and frequency measurements;
- Phase sequence;
- Power and THD measurement (up to the 12<sup>th</sup> harmonic);
- RCD testing (general and selective, type AC, A, F, B, B+, **MI RCD**, **EV RCD**, **EV RCM**, **PRCD**, **PRCD-K**, **PRCD-S**);
- Earth resistance (3-wire and 2-clamps method);
- Specific earth resistance with Ro-adaptor (option);
- TRMS leakage and load currents (option);
- First fault leakage current (ISFL);
- Testing of Insulation Monitoring Devices (IMDs);
- Illumination (option);
- High resolution Loop impedance (mΩ) (option);
- **EVSE AUTO SEQUENCES and function inspections**;

- Determining location of cables (option);
- QR and/or barcode scanner support (option).

### KEY FEATURES

- **Predefined profile dependent AUTO SEQUENCES**.
- Predefined **Automatic tests**:  
Auto TT (U, ZIn, Zs, Uc);  
Auto TN/RCD (U, ZIn, Zs, Rpe);  
Auto TN (U, ZIn, Zlpe, Rpe);  
Auto IT (U, ZIn, Isc, Isfl, IMD).
- **High resolution colour touch screen**, 4.3" TFT
- **Built-in help screens** for referencing on site.
- **Built-in fuse tables** for automatic evaluation of the line / loop impedance result.
- Monitoring of all 3 voltages in real-time.
- **Automatic polarity reversal** on continuity test.
- Automated RCD testing procedure.
- **Automated Impedance** testing procedure (**Z AUTO**).
- **Functional inspections**.
- **Measurement filtering according to the selected area group**.
- Built-in charger and rechargeable batteries as standard accessory.
- **BT communication with PC, Android tablets and smart phones** via built-in BT.
- PC SW **Metrel ES Manager** (structure and report creation, data upload/download).
- Optional **aMESM Android app** (structure and report creation, data upload/download).

### APPLICATION

- Testing of TT, TN and IT systems;
- Testing of single and multiphase systems;
- Initial and periodic testing of domestic installations;
- Maintenance;
- Lightning installations;
- Medical installation testing;
- Fire brigades, military and police vehicles;
- Construction sites;
- Mobile Video/Audio, Concert Halls, Fair, Playground;
- Electrical Vehicle Supply Equipment (EVSE) testing.

### STANDARDS

#### Functionality:

- EN 61557; DIN 5032

#### Other reference standards for testing:

- IEC/EN/HD 60364-4-41;
- IEC/EN 61008; IEC/EN 61009; **IEC 62572**;
- **EN 62955**; BS 7671; AS/NZ 3017

#### Electromagnetic compatibility (EMC):

- IEC/EN 61326-1

#### Safety:

- IEC/EN 61010-1; IEC/EN 61010-031;
- IEC/EN 61010-2-030; IEC/EN 61010-2-032



## TECHNICAL DATA

FUNCTION		Measuring range	Resolution	Accuracy
<b>CONTINUITY</b>	Test Current 7 mA 2-wire	0.00 Ω ... 19.99 Ω 20.0 Ω ... 1999 Ω	0.1 Ω 1 Ω	±(5 % of r. + 3 digits)
	Test Current 200 mA 2-wire	0.00 Ω ... 19.99 Ω 20.0 Ω ... 199.9 Ω 200.0 Ω ... 1999 Ω	0.01 Ω 0.1 Ω 1 Ω	±(3 % of r. + 3 digits) ±(5 % of r.) ±(5 % of r.)
<b>INSULATION RESISTANCE</b>	Test Voltage 50/100/250 V	0.00 MΩ ... 19.99 MΩ 20.0 MΩ ... 99.9 MΩ 100.0 MΩ ... 199.9 MΩ	0.01 MΩ 0.1 MΩ	±(5 % of r. + 3 digits) ±(10 % of r.) ±(20 % of r.)
	Test Voltage 500/1000 V	0.00 MΩ ... 19.99 MΩ 20.0 MΩ ... 199.9 MΩ 200 MΩ ... 999 MΩ	0.01 MΩ 0.1 MΩ 1 MΩ	±(5 % of r. + 3 digits) ±(5 % of r.) ±(10 % of r.)
<b>RCD</b>	RCD Uc	0.00 V ... 19.99 V 20.0 V ... 99.9 V	0.1 V	(-0 % / +15 %) of r. ± 10 digits (-0 % / +15 %) of r.
	RCD (t), RCD I Ramp	0.00 ms ... 40.0 ms 0.0 V ... max. time	0.1 ms	±1 ms ±3 ms
		0.2xIΔN ... 1.1xIΔN (AC) 0.2xIΔN ... 1.5xIΔN (A), IΔN ≥30 mA 0.2xIΔN ... 2.2xIΔN (A), IΔN <30 mA 0.2xIΔN ... 2.2xIΔN (B)	0.05xIΔN	±0.1xIΔN
<b>IMPEDANCE</b>	Zline L-L, L-N Ipsc	0.00 Ω ... 9.99 Ω 10.0 Ω ... 99.9 Ω 100 Ω ... 999 Ω 1.00 kΩ ... 9.99 kΩ	0.01 Ω 0.1 Ω 1 Ω 10 Ω	±(5 % of r. + 5 digits) ±(10 % of r.)
	Zloop L-PE, Ipfc	0.00 Ω ... 9.99 Ω 10.0 Ω ... 99.9 Ω 100 Ω ... 999 Ω 1.00 kΩ ... 9.99 kΩ	0.01 Ω 0.1 Ω 1 Ω 10 Ω	±(5 % of r. + 5 digits) ±(10 % of r.)
<b>VOLTAGE</b>	TRMS	0 ... 550 V	1 V	±(2 % of r. + 2 digits)
	Frequency	0.00 Hz ... 9.99 Hz 10.0 Hz ... 499.9 Hz	0.01 Hz 0.1 Hz	±(0.2 % of r. + 1 digits)
<b>CURRENT</b>	TRMS, AC with A 1018	0.0 mA ... 99.9 mA 100 mA ... 999 mA 1.00 A ... 19.99 A	0.1 mA 1 mA 0.01 A	±(5 % of r. + 5 digits) ±(3 % of r. + 3 digits) ±(3 % of r.)
	TRMS, AC/DC with A 1391, range = 40 A	0.00 A ... 1.99 A 2.00 A ... 19.99 A 20.0 A ... 39.9 A	0.01 A 0.01 A 0.1 A	±(3 % of r. + 3 digits) ±(3 % of r.) ±(3 % of r.)
	TRMS, AC/DC with A 1391, range = 300 A	0.00 A ... 19.99 A 20.0 A ... 39.9 A 40.0 A ... 299.9 A	0.01 A 0.1 A 0.1 A	Indicative ±(3 % of r. + 5 digits)
<b>EARTH RESISTANCE</b>	3 wire	0.00 Ω ... 19.99 Ω 20.0 Ω ... 199.9 Ω 200.0 Ω ... 9999 Ω	0.01 Ω 0.1 Ω 1 Ω	±(5 % of r. + 5 digits)
	2 clamp	0.00 Ω ... 19.99 Ω 20.0 Ω ... 30.0 Ω 30.1 Ω ... 39.9 Ω	0.01 Ω 0.1 Ω 0.1 Ω	±(10 % of r. + 10 digits) ±(20 % of r.) ±(30 % of r.)
	Specific earth resistance	0.0 Ωm ... 99.9 Ωm 100 Ωm ... 999 Ωm 1.00 kΩm ... 9.99 kΩm 10.0 kΩm ... 99.9 kΩm 100 kΩm ... 9999 kΩm	0.1 Ωm 1 Ωm 0.01 kΩm 0.1 kΩm	±(5 % of r.) for Re 1 Ω ... 1999kΩ ±(10 % of r.) for Re 2 kΩ ... 19.99kΩ ±(20 % of r.) for Re > 20 kΩ
<b>FIRST FAULT LEAKAGE CURRENT</b>		0.0 mA ... 19.9 mA	0.1 mA	±(5 % of r. + 3 digits)
<b>IMD TEST</b>	Threshold indicative insulation resistance	5 ... 640 kΩ	5 kΩ	Indicative values, up to 128 steps
<b>ILLUMINANCE</b>	Type B	0.01 lux ... 19.99 lux 20.0 lux ... 199.9 lux 200 lux ... 1999 lux 2.00 klux ... 19.99 klux	0.01 lux 0.1 lux 1 lux 10 lux	±(5 % of r. + 2 digits) ±(5 % of r.)
	Type C	0.01 lux ... 19.99 lux 20.0 lux ... 199.9 lux 200 lux ... 1999 lux 2.00 klux ... 19.99 klux	0.01 lux 0.1 lux 1 lux 10 lux	±(10 % of r. + 3 digits) ±(10 % of r.)
<b>GENERAL</b>	Power supply	9 VDC (6x1.5 V battery or accu, size AA)		
	Overvoltage category	600 V CAT III; 300 V CAT IV		
	Protection class	double insulation		
	COM port	BT, USB, RS232		
	Display	Colour TFT display, 4.3 inch, 480 x 272 pixels		
	Weight Dimensions	1.3 kg 230 x 103 x 115 mm		

### STANDARD SET

#### MI 3152 ST

- Instrument MI 3152 EurotestXC
- Plug commander, 1.5 m
- Test lead, 3 x 1.5 m
- Power supply adapter + 6 NiMH rechargeable batteries, type AA
- Test probe, 3 pcs (blue, black, green)
- Crocodile clip, 3 pcs (blue, black, green)
- Earth set 20 m
- RS232 - PS/2 cable
- USB cable
- Soft carrying bag

- Soft carrying neck belt
- Metrel ES Manager BASIC Licence\*
- Short instruction manual

#### MI 3152 EU

- MI 3152 ST
- Current clamp A 1018 (low range, leakage)
- Current clamp A 1019
- Metrel ES Manager PRO Licence\*

\*Metrel ES Manager can be downloaded free of charge from Metrel Web server.



Picture of MI 3152 EU set

# Multifunctional installation testers

## MI 3152H EurotestXC 2,5 kV



MI 3152H EurotestXC 2,5 kV is an instrument from the new generation of Metrel's multifunctional measuring instruments. The already well known functions like complete installation safety testing according to IEC/EN 61557 and AUTO SEQUENCE testing of TN and TT earthing systems expanded with insulation resistance measurement with the test voltage up to 2,5 kV are managed by a completely new user interface based on large colour touch screen display. A wide range of functions is included: from on-line voltage monitoring, phase sequence testing, varistor testing, earth resistance measurement with 3 wire and 2 clamps method and illuminance measurement, TRMS current measurement up to RCD tests, line and loop impedance tests as well as diagnostic test enabled by PI and DAR indexes calculation.

### MEASURING FUNCTIONS

- Insulation resistance with **DC voltage from 50 V to 2500 V and PI, DAR calculation;**
- **Varistor test;**
- Continuity of PE conductors with 200 mA DC test current with polarity change;
- Continuity of PE conductors with 7 mA test current without RCD tripping;
- Line/Loop impedance combined also in one function **Z AUTO;**
- Loop impedance with Trip Lock (EV) RCD function;
- TRMS voltage and frequency measurements;
- Phase sequence;
- Power and THD measurement (up to the 12th harmonic);
- RCD testing (general and selective, type AC, A, F, **MI RCD, EV RCD, EV RCM, PRCD, PRCD-K, PRCD-S**);
- Earth resistance (3-wire and 2-clamps method);
- Specific earth resistance with Ro-adapter (option);
- TRMS leakage and load currents (option);
- Illumination (option);
- High resolution Loop impedance (mΩ) (option);
- **EVSE AUTO SEQUENCES and function inspections;**

- Determining location of cables (option);
- QR and/or barcode scanner support (option).

### KEY FEATURES

- **Predefined profile dependent AUTO SEQUENCES.**
- Predefined **Automatic tests:**  
Auto TT (U, ZIn, Zs, Uc);  
Auto TN/RCD (U, ZIn, Zs, Rpe);  
Auto TN (U, ZIn, Zlpe, Rpe).
- **High resolution colour touch screen, 4.3" TFT**
- **Built-in help screens** for referencing on site.
- **Built-in fuse tables** for automatic evaluation of the line / loop impedance result.
- Monitoring of all 3 voltages in real-time.
- **Automatic polarity reversal** on continuity test.
- Automated RCD testing procedure.
- **Automated Impedance testing procedure (Z AUTO).**
- **Functional inspections.**
- **Measurement filtering according to the selected area group.**
- Built-in charger and rechargeable batteries as standard accessory.
- **BT communication with PC, Android tablets and smart phones** via built-in BT.

- PC SW **Metrel ES Manager** (structure and report creation, data upload/download).
- Optional **aMESM Android app** (structure and report creation, data upload/download).

### APPLICATION

- Testing of TT and TN supply systems;
- Testing of single and multiphase systems;
- Initial and periodic testing of domestic and industrial installations;
- Lightning installations;
- Observation of insulation trends;
- Electrical Vehicle Supply Equipment (EVSE) testing.

### STANDARDS

#### Functionality:

- EN 61557; DIN 5032

#### Other reference standards for testing:

- IEC/EN/HD 60364-4-41; IEC/EN 61008; IEC/EN 61009; **IEC 62572; EN 62955;** BS 7671; AS/NZ 3017

#### Electromagnetic compatibility (EMC):

- IEC/EN 61326-1

#### Safety:

- IEC/EN 61010-1; IEC/EN 61010-031; IEC/EN 61010-2-030; IEC/EN 61010-2-032

## TECHNICAL DATA

FUNCTION		Measuring range	Resolution	Accuracy
<b>CONTINUITY</b>	Test Current 7 mA 2-wire	0.00 Ω ... 19.99 Ω 20.0 Ω ... 1999 Ω	0.1 Ω 1 Ω	±(5 % of r. + 3 digits)
	Test Current 200 mA 2-wire	0.00 Ω ... 19.99 Ω 20.0 Ω ... 199.9 Ω 200.0 Ω ... 1999 Ω	0.01 Ω 0.1 Ω 1 Ω	±(3 % of r. + 3 digits) ±(5 % of r.) ±(5 % of r.)
<b>INSULATION RESISTANCE</b>	Test Voltage 50/100/250 V	0.00 MΩ ... 19.99 MΩ 20.0 MΩ ... 99.9 MΩ 100.0 MΩ ... 199.9 MΩ	0.01 MΩ 0.1 MΩ	±(5 % of r. + 3 digits) ±(10 % of r.) ±(20 % of r.)
	Test Voltage 500/1000 V	0.00 MΩ ... 19.99 MΩ 20.0 MΩ ... 199.9 MΩ 200 MΩ ... 999 MΩ	0.01 MΩ 0.1 MΩ 1 MΩ	±(5 % of r. + 3 digits) ±(5 % of r.) ±(10 % of r.)
	Test Voltage 2500 V	0.00 MΩ ... 19.99 MΩ 20.0 MΩ ... 199.9 MΩ 200 MΩ ... 999 MΩ 1.00 GΩ ... 19.99 GΩ	0.01 MΩ 0.1 MΩ 1 MΩ 0.01 GΩ	±(5 % of r. + 3 digits) ±(5 % of r.) ±(10 % of r.) ±(10 % of r.)
<b>INSULATION ANALAYSING RCD</b>	Calculation of PI, DAR Only for test voltage 500/1000/2500 V	0.01 MΩ ... 9.99 MΩ 10.0 MΩ ... 100 MΩ	0.01 MΩ 0.1 MΩ	±(5 % of r. + 2 digits) ±(5 % of r.)
	RCD Uc	0.00 V ... 19.99 V 20.0 V ... 99.9 V	0.1 V	(-0 % / +15 %) of r. ± 10 digits (-0 % / +15 %) of r.
	RCD (t), RCD I Ramp	0.00 ms ... 40.0 ms 0.0 V ... max.time 0.2xIΔN ... 1.1xIΔN (AC) 0.2xIΔN ... 1.5xIΔN (A), IΔN ≥ 30 mA) 0.2xIΔN ... 2.2xIΔN (A), IΔN < 30 mA)	0.1 ms 0.05xIΔN	±1 ms ±3 ms ±0.1xIΔN
<b>IMPEDANCE</b>	Zline L-L, L-N Ipssc	0.00 Ω ... 9.99 Ω 10.0 Ω ... 99.9 Ω 100 Ω ... 999 Ω 1.00 kΩ ... 9.99 kΩ	0.01 Ω 0.1 Ω 1 Ω 10 Ω	±(5 % of r. + 5 digits) ±(10 % of r.)
	Zloop L-PE, Ipfc	0.00 Ω ... 9.99 Ω 10.0 Ω ... 99.9 Ω 100 Ω ... 999 Ω 1.00 kΩ ... 9.99 kΩ	0.01 Ω 0.1 Ω 1 Ω 10 Ω	±(5 % of r. + 5 digits) ±(10 % of r.)
<b>VOLTAGE</b>	TRMS	0 ... 550 V	1 V	±(2 % of r. + 2 digits)
	Frequency	0.00 Hz ... 9.99 Hz 10.0 Hz ... 499.9 Hz	0.01 Hz 0.1 Hz	±(0.2 % of r. + 1 digits)
<b>CURRENT</b>	TRMS, AC with A 1018	0.0 mA ... 99.9 mA 100 mA ... 999 mA 1.00 A ... 19.99 A	0.1 mA 1 mA 0.01 A	±(5 % of r. + 5 digits) ±(3 % of r. + 3 digits) ±(3 % of r.)
	TRMS, AC/DC with A 1391, range=40 A	0.00 A ... 1.99 A 2.00 A ... 19.99 A 20.0 A ... 39.9 A	0.01 A 0.01 A 0.1 A	±(3 % of r. + 3 digits) ±(3 % of r.) ±(3 % of r.)
	TRMS, AC/DC with A 1391, range = 300 A	0.00 A ... 19.99 A 20.0 A ... 39.9 A 40.0 A ... 299.9 A	0.01 A 0.1 A 0.1 A	Indicative Indicative ±(3 % of r. + 5 digits)
<b>EARTH RESISTANCE</b>	3 wire	0.00 Ω ... 19.99 Ω 20.0 Ω ... 199.9 Ω 200.0 Ω ... 9999 Ω	0.01 Ω 0.1 Ω 1 Ω	±(5 % of r. + 5 digits)
	2 clamp	0.00 Ω ... 19.99 Ω 20.0 Ω ... 30.0 Ω 30.1 Ω ... 39.9 Ω	0.01 Ω 0.1 Ω 0.1 Ω	±(10 % of r. + 10 digits) ±(20 % of r.) ±(30 % of r.)
	Specific earth resistance	0.0 Ωm ... 99.9 Ωm 100 Ωm ... 999 Ωm 1.00 kΩm ... 9.99 kΩm 10.0 kΩm ... 99.9 kΩm 100 kΩm ... 9999 kΩm	0.1 Ωm 1 Ωm 0.01 kΩm 0.1 kΩm 1 kΩm	±(5 % of r.) for Re 1 Ω ... 1999kΩ ±(10 % of r.) for Re 2 kΩ ... 19.99kΩ ±(20 % of r.) for Re > 20 kΩ
<b>ILLUMINANCE</b>	Type B	0.01 lux ... 19.99 lux 20.0 lux ... 199.9 lux 200 lux ... 1999 lux 2.00 klux ... 19.99 klux	0.01 lux 0.1 lux 1 lux 10 lux	±(5 % of r. + 2 digits) ±(5 % of r.)
	Type C	0.01 lux ... 19.99 lux 20.0 lux ... 199.9 lux 200 lux ... 1999 lux 2.00 klux ... 19.99 klux	0.01 lux 0.1 lux 1 lux 10 lux	±(10 % of r. + 3 digits) ±(10 % of r.)
<b>GENERAL</b>	Power supply	9 VDC (6x1.5 V battery or accu, size AA)		
	Overtoltage category	1000 V DC CAT II; 600 V CAT III; 300 V CAT IV		
	Protection class	double insulation		
	COM port	BT, USB, RS232		
	Display	Colour TFT display, 4.3 inch, 480 x 272 pixels		
	Weight Dimensions	1.3 kg 230 x 103 x 115 mm		

### STANDARD SET

#### MI 3152H

- Instrument MI 3152H EurotestXC
- Plug commander, 1.5 m
- 2.5 kV test lead, 2 x 1.5 m
- Test lead, 3 x 1.5 m
- Power supply adapter + 6 NiMH rechargeable batteries, type AA
- Test probe, 4 pcs (blue, black, green, red)
- Crocodile clip, 4 pcs (blue, black, green, red)
- Earth set 20 m
- RS232 - PS/2 cable

- USB cable
- Soft carrying bag
- Soft carrying neck belt
- Metrel ES Manager BASIC Licence\*
- Short instruction manual

\*Metrel ES Manager can be downloaded free of charge from Metrel Web server.



Picture of MI 3152H set

# Multifunctional installation testers

## MI 3102 BT EurotestXE



MI 3102 BT EurotestXE is a multifunctional measuring instrument which performs a complete set of installation safety tests according to IEC/EN 61557. It supports **AUTO SEQUENCE**® testing of the TN, TT and IT earthing systems. ISFL measurements and the IMD tests can be performed. Besides, the MI 3102 BT EurotestXE enables on-line voltage monitoring, phase sequence testing, earth resistance measurement, illuminance measurement and TRMS current measurement. EurotestXE is equipped with integrated characteristics of fuses and RCDs for PASS / FAIL evaluation of test results. All the results can be quickly saved and referenced on the instrument and then downloaded via the EuroLink PRO software (included in the standard set) to the computer for evaluation and report generation after testing.



### MEASURING FUNCTIONS

- Insulation resistance with DC voltage from 50 V to 1000 V;
- Continuity of PE conductors with 200 mA DC test current with polarity change;
- Continuity of PE conductors with 7 mA test current without RCD tripping;
- Line/Loop impedance;
- Loop impedance with Trip Lock RCD function;
- TRMS voltage and frequency;
- Phase sequence;
- Power and harmonics;
- RCD testing (general and selective, type AC, A, F, B, B+);
- Earth resistance (3-wire and 2-clamps method);
- Specific earth resistance with Ro-adapter (option);
- TRMS leakage and load currents (option);
- First fault leakage current (ISFL);
- Testing of Insulation Monitoring Devices (IMDs);
- Illumination (option).

### KEY FEATURES

- **Predefined mini AUTO SEQUENCE® s:**
  - Auto TT (U, Zln, Zs, Uc);
  - Auto TN/RCD (U, Zln, Zs, Rpe);
  - Auto TN (U, Zln, Zlpe, Rpe);
  - Auto IT (U, Zln, Isc, Isfl, IMD).
- **Power** measurements and harmonics analysis.
- **Built-in help screens** for referencing on site.
- **Built-in fuse tables** for automatic evaluation of the line / loop impedance result.
- **On-line voltage monitoring:** monitors all 3 voltages in real-time.
- **Polarity swap:** automatic polarity reversal on continuity test.
- **Trip Lock function:** loop impedance test without tripping the (EV) RCD.
- **Built-in charger** unit has a built-in charging circuit and comes complete with a set of rechargeable NiMH batteries.
- **RCD auto:** automated RCD testing procedure.
- **Bluetooth communication** with PC, Android tablets and smart phones via built-in BT.
- **PC SW EuroLink PRO** for downloading of test results and report creation.
- **EuroLink Android app**, data management tool (option).

### APPLICATION

- Initial and periodic testing of domestic and industrial installations.
- Testing of single and multiphase systems.
- Testing of TT, TN and IT earthing systems.
- Medical installation testing.

### STANDARDS

#### Functionality:

- EN 61557;
- DIN 5032

#### Other reference standards for testing:

- IEC/EN 60364-4-41;
- EN 61008;
- EN 61009;
- BS 7671;
- AS/NZ 3017;
- CEI 64.8;
- HD 384;
- VDE 413

#### Electromagnetic compatibility:

- EN 61326

#### Safety:

- EN 61010-1;
- EN 61010-031;
- EN 31010-2-030;
- EN 31010-2-032

## TECHNICAL DATA

FUNCTION		Measuring range	Resolution	Accuracy
<b>CONTINUITY</b>	Test Current 7 mA 2-wire	0.00 Ω ... 19.99 Ω 20.0 Ω ... 1999 Ω	0.1 Ω 1 Ω	±(5 % of r. + 5 digits)
	Test Current 200 mA 2-wire	0.00 Ω ... 19.99 Ω 20.0 Ω ... 199.9 Ω 200.0 Ω ... 1999 Ω	0.01 Ω 0.1 Ω 1 Ω	±(3 % of r. + 3 digits) ±(5 % of r.) ±(5 % of r.)
<b>INSULATION RESISTANCE</b>	Test Voltage 50/100/250 V	0.00 MΩ ... 19.99 MΩ 20.0 MΩ ... 99.9 MΩ 100.0 MΩ ... 999.9 MΩ	0.01 MΩ 0.1 MΩ 1 MΩ	±(5 % of r. + 3 digits) ±(10 % of r.) ±(20 % of r.)
	Test Voltage 500/1000 V	0.00 MΩ ... 19.99 MΩ 20.0 MΩ ... 99.9 MΩ 200 MΩ ... 999 MΩ	0.01 MΩ 0.1 MΩ 1 MΩ	±(5 % of r. + 3 digits) ±(5 % of r.) ±(10 % of r.)
<b>RCD</b>	Contact voltage	0.00 V ... 19.99 V 20.0 V ... 99.9 V	0.1 V	(-0%/±15 %) of r. ± 10 digits (-0%/±15 %) of r.
	Trip out time	0.0 ms ... 40.0 ms 0.0 ms ... max.time	0.1 ms	±1 ms ±3 ms
	Trip out current	0.2xIΔN ... 1.1xIΔN (AC) 0.2xIΔN ... 1.5xIΔN (A) IΔN ≥30 mA) 0.2xIΔN ... 2.2xIΔN (A) IΔN <30 mA)	0.05xIΔN	±0.1xIΔN
<b>IMPEDANCE</b>	Zline L-L, L-N Ipsc	0.00 Ω ... 9.99 Ω 10.0 Ω ... 99.9 Ω 100 Ω ... 999 Ω 1.00 kΩ ... 9.99 kΩ	0.01 Ω 0.1 Ω 1 Ω 10 Ω	±(5 % of r. + 5 digits) ±(10 % of r.)
	Zloop L-PE, Ipfc	0.00 Ω ... 9.99 Ω 10.0 Ω ... 99.9 Ω 100 Ω ... 999 Ω 1.00 kΩ ... 9.99 kΩ	0.01 Ω 0.1 Ω 1 Ω 10 Ω	±(5 % of r. + 5 digits) ±(10 % of r.)
<b>VOLTAGE</b>	TRMS	0 ... 550 V	1 V	±(2 % of r. + 2 digits)
	Frequency	0.00 Hz ... 9.99 Hz 10.0 Hz ... 499.9 Hz	0.01 Hz 0.1 Hz	±(0.2 % of r. + 1 digits)
<b>CURRENT</b>	TRMS, AC with A 1018	0.0 mA ... 99.9 mA 100 mA ... 999 mA 1.00 A ... 19.99 A	0.1 mA 1 mA 0.01 A	±(5 % of r. + 5 digits) ±(3 % of r. + 3 digits) ±(3 % of r.)
	TRMS, AC/DC with A 1391, range=40A	0.00 A ... 1.99 A 2.00 A ... 19.99 A 20.0 A ... 39.9 A	0.01 A 0.01 A 0.1 A	±(3 % of r. + 3 digits) ±(3 % of r.) ±(3 % of r.)
	TRMS, AC/DC with A 1391, range=300A	0.00 A ... 19.99 A 20.0 A ... 39.9 A 40.0 A ... 299.9 A	0.01 A 0.1 A 0.1 A	indicative ±(3 % of r. + 5 digits)
<b>EARTH RESISTANCE</b>	3 wire	0.00 Ω ... 19.99 Ω 20.0 Ω ... 199.9 Ω 200.0 Ω ... 9999 Ω	0.01 Ω 0.1 Ω 1 Ω	±(5 % of r. + 5 digits)
	2 clamp	0.00 Ω ... 19.99 Ω 20.0 Ω ... 30.0 Ω 30.1 Ω ... 99.9 Ω	0.01 Ω 0.1 Ω 0.1 Ω	±(10 % of r. + 10 digits) ±(20 % of r.) ±(30 % of r.)
	Specific earth resistance	0.0 Ωm ... 99.9 Ωm 100 Ωm ... 999 Ωm 1.00 Ωmk ... 9.99 kΩm 10.0 Ωmk ... 99.9 kΩm	0.1 Ωm 1 Ωm 0.01 kΩm 0.1 kΩm	±(5 % of r.) for Re 1 Ω ... 1999kΩ ±(10 % of r.) for Re 2 kΩ ... 19.99kΩ ±(20 % of r.) for Re > 20 kΩ
<b>ILLUMINANCE</b>	Type B	0.01 lux ... 19.99 lux 20.0 lux ... 199.9 lux 200 lux ... 1999 lux 2.00 klux ... 19.99 klux	0.01 lux 0.1 lux 1 lux 10 lux	±(5 % of r. + 2 digits) ±(5 % of r.)
	Type C	0.01 lux ... 19.99 lux 20.0 lux ... 199.9 lux 200 lux ... 1999 lux 2.00 klux ... 19.99 klux	0.01 lux 0.1 lux 1 lux 10 lux	±(10 % of r. + 3 digits) ±(10 % of r.)
<b>GENERAL</b>	Power supply	9 VDC (6x1.5 V battery or accu, size AA)		
	Overvoltage category	CAT II / 1000 VDC; CAT III / 600 V; CAT IV / 300 V		
	Protection class	Double insulation		
	COM port	BT, USB, RS232		
	Weight	1.3 kg		
Dimensions	230 x 103 x 115 mm			

### STANDARD SET

#### MI 3102 BT

- Instrument EurotestXE
- Plug commander, 1.5 m
- Test lead, 3 x 1.5 m
- Earth test set, 3-wire, 20 m (test lead, 4 m; 2 x test lead, 20 m; 2 x test rod)
- Power supply adapter + 6 NiMH rechargeable batteries, size AA
- PC Software EuroLink PRO
- Test probe, 3 pcs (blue, black, green)

- Crocodile clip, 3 pcs (blue, black, green)
- RS232 - PS/2 cable
- USB cable
- Soft carrying neck belt
- Soft carrying bag
- Short instruction manual
- Instruction manual on storage media
- Handbook on storage media
- Calibration certificate



Picture of MI 3102 BT set

# Multifunctional installation testers

## MI 3102H BT EurotestXE 2,5 kV



MI 3102H BT EurotestXE 2,5 kV is a multifunctional measuring instrument which apart from all the necessary functions for complete installation safety testing according to IEC/EN 61557 performs insulation resistance measurement with the test voltage up to 2,5 kV (measuring range is up to 20 G $\Omega$ ) and enables diagnostic test by PI and DAR indexes calculation. Besides, the MI 3102H BT EurotestXE 2,5 kV enables on-line voltage monitoring, phase sequence testing, earth resistance measurement, illuminance measurement and TRMS current measurement. EurotestXE 2,5 kV is equipped with integrated characteristics of fuses and RCDs for PASS / FAIL evaluation of test results. All the results can be quickly saved and referenced on the instrument and then downloaded via the EuroLink PRO software (included in the standard set) to the computer for evaluation and report generation after testing.

### MEASURING FUNCTIONS

- Insulation resistance with DC voltage 50 V to 2,5 kV and PI, DAR calculation;
- Continuity of PE conductors with 200 mA DC test current with polarity change;
- Continuity of PE conductors with 7 mA test current without RCD tripping;
- Continuity RPE with 200 mA AC on outlet;
- Line/Loop impedance;
- Loop impedance with Trip Lock RCD function;
- TRMS voltage and frequency;
- Phase sequence;
- Power and harmonics;
- RCD testing (general and selective, type AC, A, F);
- Earth resistance (3-wire and 2-clamps method);
- Specific earth resistance with Ro-adaptor (option);
- TRMS leakage and load currents (option);
- Illumination (option).

### KEY FEATURES

- **Predefined mini AUTO SEQUENCE® s:**
  - Auto TT (U, ZIn, Zs, Uc);
  - Auto TN/RCD (U, ZIn, Zs, Rpe);
  - Auto TN (U, ZIn, Zlpe, Rpe).

- **Insulation range:** wide range of insulation test voltages from 100 V to 2500 V, readings up to 20 G $\Omega$ .
- **Insulation diagnostics:** polarisation Index (PI) and Dielectric Absorption Ratio (DAR) calculation.
- **Power measurements and harmonics analysis.**
- **Built-in help screens** for referencing on site.
- **Built-in fuse tables** for automatic evaluation of the line / loop impedance result.
- **On-line voltage monitoring:** monitors all 3 voltages in real-time.
- **Polarity swap:** automatic polarity reversal on continuity test.
- **Trip Lock function:** loop impedance test without tripping the (EV) RCD.
- **Built-in charger & rechargeable batteries:** unit has a built-in charging circuit and comes complete with a set of rechargeable NiMH batteries.
- **RCD auto:** automated RCD testing procedure.
- **Bluetooth communication** with PC, Android tablets and smart phones via built-in BT.
- **PC SW EuroLink PRO** for downloading of test results and report creation.
- **EuroLink Android app,** data management tool (option).

### APPLICATION

- Initial and periodic testing of domestic and industrial installations.
- Testing of Insulation resistance of transformers, motors, cables, machines, etc.
- Observation of insulation trends.
- Testing of single and multiphase systems.
- Testing of TT and TN supply systems.

### STANDARDS

#### Functionality:

- IEC/EN 61557

#### Other reference standards for testing:

- IEC/EN 60364;
- EN 61008;
- EN 61009;
- EN 60755;
- BS 7671;
- AS/NZ 3760;
- CEI 64.8;
- HD 384;
- VDE 413

#### Electromagnetic compatibility:

- EN 61326

#### Safety:

- EN 61010-1;
- EN 61010-031;
- EN 31010-2-030;
- EN 31010-2-032

## TECHNICAL DATA

FUNCTION		Measuring range	Resolution	Accuracy
<b>CONTINUITY</b>	Test Current 7 mA 2-wire	0.00 Ω ... 19.99 Ω 20.0 Ω ... 1999 Ω	0.1 Ω 1 Ω	±(5 % of r. + 5 digits)
	Test Current 200 mA 2-wire	0.00 Ω ... 19.99 Ω 20.0 Ω ... 199.9 Ω 200.0 Ω ... 1999 Ω	0.01 Ω 0.1 Ω 1 Ω	±(3 % of r. + 3 digits) ±(5 % of r.) ±(5 % of r.)
<b>INSULATION RESISTANCE</b>	Test Voltage 50/100/250 V	0.00 MΩ ... 19.99 MΩ 20.0 MΩ ... 99.9 MΩ 100.0 MΩ ... 199.9 MΩ	0.01 MΩ 0.1 MΩ 1 MΩ	±(5 % of r. + 3 digits) ±(10 % of r.) ±(20 % of r.)
	Test Voltage 500/1000 V	0.00 MΩ ... 19.99 MΩ 20.0 MΩ ... 99.9 MΩ 200 MΩ ... 999 MΩ	0.01 MΩ 0.1 MΩ 1 MΩ	±(5 % of r. + 3 digits) ±(5 % of r.) ±(10 % of r.)
	Test Voltage 2500 V	0.00 MΩ ... 19.99 MΩ 20.0 MΩ ... 199.9 MΩ 200 MΩ ... 999 MΩ 1.00 GΩ ... 19.99 GΩ	0.01 MΩ 0.1 MΩ 0.1 MΩ 0.01 GΩ	±(5 % of r. + 3 digits) ±(5 % of r.) ±(10 % of r.) ±(10 % of r.)
<b>INSULATION ANALYSING RCD</b>	Calculation of PI, DAR Only for test voltage 500/1000/2500 V	0.01 MΩ ... 9.99 MΩ 10.0 MΩ ... 100 MΩ	0.01 MΩ 0.1 MΩ	±(5 % of r. + 2 digits) ±(5 % of r.)
	Contact voltage	0.00 V ... 19.99 V 20.0 V ... 99.9 V	0.1 V	(-0%/±15 %) of r. ± 10 digits (-0%/±15 %) of r.
	Trip out time	0.0 ms ... 40.0 ms 0.0 ms ... max.time	0.1 ms	±1 ms ±3 ms
	Trip out current	0.2xIΔN ... 1.1xIΔN (AC) 0.2xIΔN ... 1.5xIΔN (A) IΔN ≥30 mA) 0.2xIΔN ... 2.2xIΔN (A) IΔN <30 mA)	0.05xIΔN	±0.1xIΔN
<b>IMPEDANCE</b>	Zline L-L, L-N Ipfc	0.00 Ω ... 9.99 Ω 10.0 Ω ... 99.9 Ω 100 Ω ... 999 Ω 1.00 kΩ ... 9.99 kΩ	0.01 Ω 0.1 Ω 1 Ω 10 Ω	±(5 % of r. + 5 digits) ±(10 % of r.)
	Zloop L-PE, Ipfc	0.00 Ω ... 9.99 Ω 10.0 Ω ... 99.9 Ω 100 Ω ... 999 Ω 1.00 kΩ ... 9.99 kΩ	0.01 Ω 0.1 Ω 1 Ω 10 Ω	±(5 % of r. + 5 digits) ±(10 % of r.)
<b>VOLTAGE</b>	TRMS	0 ... 550 V	1 V	±(2 % of r. + 2 digits)
	Frequency	0.00 Hz ... 9.99 Hz 10.0 Hz ... 499.9 Hz	0.01 Hz 0.1 Hz	±(0.2 % of r. + 1 digits)
<b>CURRENT</b>	TRMS, AC with A 1018	0.0 mA ... 99.9 mA 100 mA ... 999 mA 1.00 A ... 19.99 A	0.1 mA 1 mA 0.01 A	±(5 % of r. + 5 digits) ±(3 % of r. + 3 digits) ±(3 % of r.)
	TRMS, AC/DC with A 1391, range=40A	0.00 A ... 1.99 A 2.00 A ... 19.99 A 20.0 A ... 39.9 A	0.01 A 0.01 A 0.1 A	±(3 % of r. + 3 digits) ±(3 % of r.) ±(3 % of r.)
	TRMS, AC/DC with A 1391, range=300A	0.00 A ... 19.99 A 20.0 A ... 39.9 A 40.0 A ... 299.9 A	0.01 A 0.1 A 0.1 A	indicative ±(3 % of r. + 5 digits)
<b>EARTH RESISTANCE</b>	3 wire	0.00 Ω ... 19.99 Ω 20.0 Ω ... 199.9 Ω 200.0 Ω ... 9999 Ω	0.01 Ω 0.1 Ω 1 Ω	±(5 % of r. + 5 digits)
	2 clamp	0.00 Ω ... 19.99 Ω 20.0 Ω ... 30.0 Ω 30.1 Ω ... 99.9 Ω	0.01 Ω 0.1 Ω 0.1 Ω	±(10 % of r. + 10 digits) ±(20 % of r.) ±(30 % of r.)
	Specific earth resistance	0.0 Ωm ... 99.9 Ωm 100 Ωm ... 999 Ωm 1.00 Ωmk ... 9.99 kΩm 10.0 Ωmk ... 99.9 kΩm	0.1 Ωm 1 Ωm 0.01 kΩm 0.1 kΩm	±(5 % of r.) for Re 1 Ω ... 1999kΩ ±(10 % of r.) for Re 2 kΩ ... 19.99kΩ ±(20 % of r.) for Re > 20 kΩ
<b>ILLUMINANCE</b>	Type B	0.01 lux ... 19.99 lux 20.0 lux ... 199.9 lux 200 lux ... 1999 lux 2.00 klux ... 19.99 klux	0.01 lux 0.1 lux 1 lux 10 lux	±(5 % of r. + 2 digits) ±(5 % of r.)
	Type C	0.01 lux ... 19.99 lux 20.0 lux ... 199.9 lux 200 lux ... 1999 lux 2.00 klux ... 19.99 klux	0.01 lux 0.1 lux 1 lux 10 lux	±(10 % of r. + 3 digits) ±(10 % of r.)
<b>GENERAL</b>	Power supply	9 VDC (6x1.5 V battery or accu, size AA)		
	Overvoltage category	CAT II / 1000 VDC; CAT III / 600 V; CAT IV / 300 V		
	Protection class	Double insulation		
	COM port	BT, USB, RS232		
	Weight	1.3 kg		
Dimensions	230 x 103 x 115 mm			

### STANDARD SET

#### MI 3102H BT

- Instrument EurotestXE 2,5 kV
- Plug commander, 1.5 m
- 2.5 kV test lead, 2 x 1.5 m
- Test lead, 3 x 1.5 m
- Earth test set, 3-wire, 20 m (test lead, 4 m; 2 x test lead, 20 m; 2 x test rod)
- Power supply adapter + 6 NiMH rechargeable batteries, size AA
- PC Software EuroLink PRO

- Test probe, 4 pcs (blue, black, green, red)
- Crocodile clip, 4 pcs (blue, black, green, red)
- RS232 - PS/2 cable
- USB cable
- Soft carrying neck belt
- Soft carrying bag
- Short instruction manual
- Instruction manual on storage media
- Handbook on storage media
- Calibration certificate



Picture of MI 3102H BT set

# Multifunctional installation testers

## MI 3100 SE EurotestEASI



MI 3100 SE EurotestEASI is a fast, accurate and easy to use multifunctional measuring instrument which performs a complete set of installation safety tests according to IEC/EN 61557. Besides, the MI 3100 SE EurotestEASI enables on-line voltage monitoring, phase sequence testing and earth resistance measurement. EurotestEASI is equipped with integrated characteristics of fuses and RCDs for PASS / FAIL evaluation of test results. All the results can be quickly saved and referenced on the instrument and then downloaded via the EuroLink PRO software (included in the standard set) to the computer for evaluation and report generation after testing.



### MEASURING FUNCTIONS

- Insulation resistance with DC voltage from 50 V to 1000 V;
- Continuity of PE conductors with 200 mA test current with polarity change;
- Continuity of PE conductors with 7 mA test current without RCD tripping;
- Line impedance;
- Loop impedance;
- Loop impedance with Trip Lock RCD function;
- TRMS voltage and frequency;
- Phase sequence;
- RCD testing (general and selective, type AC, A, F);
- Earth resistance (3-wire method).

### KEY FEATURES

- **Predefined mini *AUTO SEQUENCE*\* s:**
  - Auto TT (U, Zln, Zs, Uc);
  - Auto TN/RCD (U, Zln, Zs, Rpe);
  - Auto TN (U, Zln, Zlpe, Rpe).
- **Built-in help screens** for referencing on site.
- **Built-in fuse tables** for automatic evaluation of the line / loop impedance result.
- **On-line voltage monitoring:** monitors all 3 voltages in real-time.
- **Polarity swap:** automatic polarity reversal on continuity test.
- **Trip Lock function:** loop impedance test without tripping the (EV) RCD.
- **Built-in charger** unit has a built-in charging circuit and comes complete with a set of rechargeable NiMH batteries.
- **RCD auto:** automated RCD testing procedure.
- **Bluetooth communication** with PC, Android tablets and smart phones via optional BT dongle.
- **PC SW EuroLink PRO** for downloading of test results and report creation.
- **EuroLink Android app,** data management tool (option).

### APPLICATION

- Initial and periodic testing of domestic and industrial installations.
- Testing of single and multiphase systems.
- Testing of TT and TN supply systems.

### STANDARDS

#### Functionality:

- IEC/EN 61557

#### Other reference standards for testing:

- IEC/EN 60364-4-41;
- EN 61008;
- EN 61009;
- BS 7671;
- AS/NZ 3017

#### Electromagnetic compatibility:

- EN 61326

#### Safety:

- EN 61010-1;
- EN 61010-031;
- EN 31010-2-030;
- EN 31010-2-032



## TECHNICAL DATA

FUNCTION		Measuring range	Resolution	Accuracy
<b>CONTINUITY</b>	Test Current 7 mA 2-wire	0.00 Ω ... 19.99 Ω 20.0 Ω ... 1999 Ω	0.1 Ω 1 Ω	±(5 % of r. + 5 digits)
	Test Current 200 mA 2-wire	0.00 Ω ... 19.99 Ω 20.0 Ω ... 199.9 Ω 200.0 Ω ... 1999 Ω	0.01 Ω 0.1 Ω 1 Ω	±(3 % of r. + 3 digits) ±(5 % of r.) ±(5 % of r.)
<b>INSULATION RESISTANCE</b>	Test Voltage 50/100/250 V	0.00 MΩ ... 19.99 MΩ 20.0 MΩ ... 99.9 MΩ 100.0 MΩ ... 999.9 MΩ	0.01 MΩ 0.1 MΩ 1 MΩ	±(5 % of r. + 3 digits) ±(10 % of r.) ±(20 % of r.)
	Test Voltage 500/1000 V	0.00 MΩ ... 19.99 MΩ 20.0 MΩ ... 99.9 MΩ 200 MΩ ... 999 MΩ	0.01 MΩ 0.1 MΩ 1 MΩ	±(5 % of r. + 3 digits) ±(5 % of r.) ±(10 % of r.)
<b>RCD</b>	Contact voltage	0.00 V ... 19.99 V 20.0 V ... 99.9 V	0.1 V	(-0%/±15 %) of r. ± 10 digits (-0%/±15 %) of r.
	Trip out time	0.0 ms ... 40.0 ms 0.0 ms ... max.time	0.1 ms	±1 ms ±3 ms
	Trip out current	0.2xI <sub>ΔN</sub> ... 1.1xI <sub>ΔN</sub> (AC) 0.2xI <sub>ΔN</sub> ... 1.5xI <sub>ΔN</sub> (A) I <sub>ΔN</sub> ≥30 mA 0.2xI <sub>ΔN</sub> ... 2.2xI <sub>ΔN</sub> (A) I <sub>ΔN</sub> <30 mA	0.05xI <sub>ΔN</sub>	±0.1xI <sub>ΔN</sub>
<b>IMPEDANCE</b>	Zline L-L, L-N Ipsc	0.00 Ω ... 9.99 Ω 10.0 Ω ... 99.9 Ω 100 Ω ... 999 Ω 1.00 kΩ ... 9.99 kΩ	0.01 Ω 0.1 Ω 1 Ω 10 Ω	±(5 % of r. + 5 digits) ±(10 % of r.)
	Zloop L-PE, Ipfc	0.00 Ω ... 9.99 Ω 10.0 Ω ... 99.9 Ω 100 Ω ... 999 Ω 1.00 kΩ ... 9.99 kΩ	0.01 Ω 0.1 Ω 1 Ω 10 Ω	±(5 % of r. + 5 digits) ±(10 % of r.)
<b>VOLTAGE</b>	TRMS	0 ... 550 V	1 V	±(2 % of r. + 2 digits)
	Frequency	0.00 Hz .. 9.99 Hz 10.0 Hz ... 499.9 Hz	0.01 Hz 0.1 Hz	±(0.2 % of r. + 1 digits)
<b>EARTH RESISTANCE</b>	3 wire	0.00 Ω ... 19.99 Ω 20.0 Ω ... 199.9 Ω 200.0 Ω ... 9999 Ω	0.01 Ω 0.1 Ω 1 Ω	±(5 % of r. + 5 digits)
	Power supply	9 VDC (6x1.5 V battery or accu, size AA)		
	Overvoltage category	CAT II / 1000 V <sub>DC</sub> ; CAT III / 600 V; CAT IV / 300 V		
Protection class	Double insulation			
COM port	BT, USB, RS232			
Weight	1.3 kg			
Dimensions	230 x 103 x 115 mm			

### STANDARD SET

#### MI 3100 SE

- Instrument EurotestEASI
- Schuko-plug test cable, 1.5 m
- Test lead, 3 x 1.5 m
- Test probe, 3 pcs (blue, black, green)
- Crocodile clip, 3 pcs (blue, black, green)
- Power supply adapter + 6 NiMH rechargeable batteries, size AA
- RS232 - PS/2 cable
- USB cable

- Soft carrying neck belt
- Soft carrying bag
- PC Software EuroLink PRO
- Short instruction manual
- Instruction manual on storage media
- Handbook on storage media
- Calibration certificate



Picture of MI 3100 SE set

# Multifunctional installation testers

## MI 3125BT EurotestCOMBO



The MI 3125BT EurotestCOMBO performs all the necessary tests for installation safety testing on TT and TN systems. The large graphic display with backlight offers easy reading of results, indications, measurement parameters and messages. Two LED Pass/Fail indicators are placed on both sides of the LCD. MI 3125BT EurotestCOMBO contains integrated characteristics of fuses and RCDs (including B type) for the evaluation of test results. Each test has its own individual help screen describing how to connect the instrument into the installation and how to perform a measurement. All the results can be quickly saved and referenced on the instrument and then downloaded via the EuroLink PRO software, included in the standard set, to the computer for evaluation and report generation after testing. MI 3125BT EurotestCOMBO performs continuity, insulation, RCD, loop, line, voltage, frequency, earth resistance testing and phase sequence tests required by the EN 61557 standard.

### MEASURING FUNCTIONS

- Insulation resistance with DC voltage;
- Continuity of PE conductors with 200 mA test current with polarity change;
- Continuity of PE conductors with 7 mA test current (continuous measurement) without RCD tripping;
- Line impedance;
- Loop impedance;
- Loop impedance with Trip Lock RCD function;
- TRMS voltage and frequency;
- Phase sequence;
- RCD testing (general and selective, type AC, A, F, B, B+ and EV RCD);
- Earth resistance (3-wire method).

### KEY FEATURES

- **LED Pass/Fail indicators:** two LED indicators for PASS / FAIL evaluation of test results are placed on both sides of the LCD
- **Help screens:** instrument comes complete with built-in help screens for referencing on site.
- **Earth resistance measurement:** instrument performs 3-wire earth resistance testing with two additional rods.
- **Built-in fuse tables:** this unique feature allows automatic evaluation of the

line / loop impedance compared to the regulations.

- **Online voltage monitoring:** monitors all 3 voltages in real-time.
- **Upgradeable:** if changes occur to the regulations, upgrades can be made to the firmware to keep the instrument up to date.
- **Polarity swap:** automatic polarity reversal on continuity test.
- **Insulation range:** wide range of insulation test voltages from 50 V to 1000 V, reading up to 1000 M $\Omega$ .
- **Trip Lock function:** Zs (RCD) function performs a loop impedance test without tripping the (EV) RCD.
- **Multi-system testing:** tests on single and multiphase TT and TN systems.
- **Built-in charger & rechargeable batteries:** unit has a built-in charging circuit and comes complete with a set of rechargeable NiMH batteries.
- **RCD auto:** automated RCD testing procedure significantly reduces test time.
- **B type RCD and EV RCD testing** are supported.
- **BT connectivity:** it enables BT communication with Android tablets and smart phones via built-in BT.
- **PC SW EuroLink PRO** included in the standard set enables downloading of test results and parameters and creation of test reports.

### APPLICATION

- Initial and periodic testing of domestic and industrial installations;
- Testing of single and multiphase systems;
- Testing of TT and TN systems.

### STANDARDS

#### Functionality:

- IEC/EN 61557

#### Other reference standards for testing:

- VDE 0413;
- IEC/EN 61008;
- IEC/EN 61009;
- IEC/EN/HD 60364;
- HD 384; BS 7671;
- IEC/TR 60755;
- CEI 64.8;
- AS/NZ 3760;
- AS/NZ 3018

#### Electromagnetic compatibility:

- IEC/EN 61326-1;
- IEC/EN 61326-2-2

#### Safety:

- IEC/EN 61010-1;
- IEC/EN 61010-031

## TECHNICAL DATA

FUNCTION	Measuring range	Resolution	Accuracy
Insulation resistance (EN 61557-2)	U = 50, 100, 250 VDC: R: 0.00 MΩ ... 19.99 MΩ 20.0 MΩ ... 99.9 MΩ 100.0 MΩ ... 199.9 MΩ	0.01 MΩ 0.1 MΩ 0.1 MΩ	±(5 % of reading + 3 digits) ±10 % of reading ±20 % of reading
	U = 500 VDC, 1 kVDC: R: 0.00 MΩ ... 19.99 MΩ 20.0 MΩ ... 99.9 MΩ 200 MΩ ... 999 MΩ	0.01 MΩ 0.1 MΩ 1 MΩ	±(5 % of reading + 3 digits) ±5 % of reading ±10 % of reading
Continuity 200 mA of PE conductor with polarity change (EN 61557-4)	0.00 Ω ... 19.99 Ω	0.01 Ω	±(3 % of reading + 3 digits)
	20.0 Ω ... 199.9 Ω	0.1 Ω	±5 % of reading
	200 Ω ... 1999 Ω	1 Ω	±5 % of reading
Low resistance continuity measurement, test current 7 mA (Continuous measurement)	0.0 Ω ... 19.9 Ω	0.1 Ω	±(5 % of reading + 3 digits)
	20 Ω ... 1999 Ω	1 Ω	±(5 % of reading + 3 digits)
Loop impedance (EN 61557-3)	0.00 Ω ... 9.99 Ω	0.01 Ω	±(5 % of reading + 5 digits)
	10.0 Ω ... 99.9 Ω	0.1 Ω	±(5 % of reading + 5 digits)
	100 Ω ... 999 Ω	1 Ω	±10 % of reading
	1.00 kΩ ... 9.99 kΩ	10 Ω	±10 % of reading
Line impedance (EN 61557-3)	0.00 Ω ... 9.99 Ω	0.01 Ω	±(5 % of reading + 5 digits)
	10.0 Ω ... 99.9 Ω	0.1 Ω	±(5 % of reading + 5 digits)
	100 Ω ... 999 Ω	1 Ω	±10 % of reading
	1.00 kΩ ... 9.99 kΩ	10 Ω	±10 % of reading
Voltage drop	0.0 % ... 99.9 %	0.1 %	Consider accuracy of line impedance
Voltage	0 V ... 550 V	1 V	±(2 % of reading + 2 digits)
Frequency	0.00 Hz ... 9.99 Hz 10.0 Hz ... 499.9 Hz	0.01 Hz 0.1 Hz	±(0.2 % of reading + 1 digits)
Phase sequence (EN 61557-7)	1.2.3 or 3.2.1		
RCD testing (EN 61557-6)	IΔN: 10 mA, 30 mA, 100 mA, 300 mA, 500 mA, 1 A		
- Contact voltage UC	0.0 V ... 19.9 V 20.0 V ... 99.9 V	0.1 V 0.1 V	(-0 % / +15 %) of reading ±10 digits (-0 % / +15 %) of reading
- Trip-out time	0 ms ... 40.0 ms 0 ms ... max. time	0.1 ms 0.1 ms	±1 ms ±3 ms
- Trip-out current	0.2 x IΔN ... 1.1 x IΔN (AC type) 0.2 x IΔN ... 2.2 x IΔN (A, F types, IΔN < 30 mA) 0.2 x IΔN ... 1.5 x IΔN (A, F types, IΔN ≥ 30 mA) 0.2 x IΔN ... 2.2 x IΔN (B, B+ types) 0.2 x IΔN ... 1.0 x IΔN (EV RCD a.c. part) 0.2 x IΔN ... 1.0 x IΔN (EV RCD d.c. part)	0.05 x IΔN 0.05 x IΔN 0.05 x IΔN 0.05 x IΔN 0.05 x IΔN 0.05 x IΔN	±0.1 x IΔN ±0.1 x IΔN ±0.1 x IΔN ±0.1 x IΔN ±0.1 x IΔN ±0.1 x IΔN
Earth resistance (EN 61557-5)	0.00 Ω ... 19.99 Ω	0.01 Ω	±(5 % of reading + 5 digits)
	20.0 Ω ... 199.9 Ω	0.1 Ω	±(5 % of reading + 5 digits)
	200 Ω ... 9999 Ω	1 Ω	±(5 % of reading + 5 digits)
Power supply	6 x 1.2 V rechargeable batteries, type AA		
Overvoltage category	CAT III / 600 V; CAT IV / 300 V		
Protection class	Double insulation		
COM port	RS232 and USB		
Dimensions	140 x 80 x 230 mm		
Weight	1.0 kg		

### STANDARD SET

#### MI 3125 BT

- Instrument EurotestCOMBO
- Set of carrying straps
- Test lead, 3 x 1.5 m
- Schuko-plug test cable, 1.5 m
- Test probe, 3 pcs (blue, black, green)
- Crocodile clip, 3 pcs (blue, black, green)
- Power supply adapter + 6 NiMH rechargeable batteries, type AA
- USB cable

- RS232 - PS/2 cable
- PC SW EuroLink PRO
- Short instruction manual
- Instruction manual and handbook on storage media
- Calibration certificate





Picture of MI 3125 BT set



# Photovoltaic and electrical installations tester

## Selection Guide for Photovoltaic and Electrical installations Testers

FEATURES	Description	MI 3108 EurotestPV	MI 3109 EurotestPV Lite
			
<b>ELECTRICAL INSTALLATION SAFETY</b>	Insulation resistance up to 1000 V	•	•
	Continuity 200 mA	•	•
	Line / Loop Impedance	•	
	RCD A, AC, B	•	
	Earth resistance	•	
	Rotary field	•	
<b>PV GENERATOR MEASUREMENTS</b>	Isc, Uoc	1000 V / 15 A	1000 V / 15 A
	Automatic test sequence		•
	I-V curve	•	•
	Umpp, Impp, Pmax	•	•
	extrapolation to STC	•	•*
	Rs (calculated in PC SW)	•	•
<b>ENVIRONMENT MEASUREMENTS</b>	Irradiance	•	•*
	Module temperature	•	•*
<b>PV SYSTEM POWER MEASUREMENTS</b>	DC side measurements U, I, P	•	•
	AC side measurements (single phase) U, I, P	•	•
	PV and inverter energy conversion efficiency	•	•
<b>EXTENDED POWER FUNCTIONALITY</b>	P, Q, S, THDU, PF/cos fi	•	
	AC/DC current	•	
	Scope function	•	
	Energy	•	
	Harmonics (up to 11 <sup>th</sup> )	•	
<b>GENERAL DATA</b>	Memory size	I-V curve: ca. 500 meas. Other: ca 1800 meas.	
	Supply	6 x AA	
	Built-in battery charger	•	•
	Display	128 x 64 BW LCD	
	Overvoltage category	CAT II / 1000 V DC CAT III / 600 V CAT IV / 300 V	
	PC connectivity	•	•
	PC Software	EuroLink PRO	EuroLink PRO
	Weight (kg)	1.3	1.3
	Dimensions (mm)	230 x 103 x 115	230 x 103 x 115

\* Environment data can be entered manually or measured with optional accessory

# Photovoltaic and electrical installations tester

## MI 3108 EurotestPV



MI 3108 EurotestPV is a combined photovoltaic tester and electrical installations safety tester. It enables complete testing of electrical installations according to EN 61557 standards and in addition performs all necessary tests required on single-phase photovoltaic (PV) installations. This includes all of the tests as required by EN 62446, but also includes I - U characteristic, Calculation of STC values as required by EN 61829 and power measurements on Inverter's DC and AC sides. The unit is designed for the demanding working conditions (up to 1000 V, with 15 A DC). To greatly improve user safety the MI 3108 EurotestPV comes with the PV Safety Probe which ensures safe disconnection every time.

### MEASURING FUNCTIONS

#### Photovoltaic installations:

##### • Measurements on DC side of PV installation:

- Voltage, current, power;
- Uoc (Open Circuit Voltage) and Isc (Short Circuit Current);
- I - U curve of PV modules and strings;
- Irradiance;
- Module temperature.

##### • Measurements on AC side of PV installation:

- Voltage, current, power;
- Efficiency of PV module, inverter, PV system calculation.

#### Electrical installations:

- Insulation resistance;
- Continuity of PE conductors;
- Line impedance;
- Loop impedance (sub-functions with high current and without RCD tripping);
- RCD testing (type AC, A and B);
- Earth resistance;
- AC current (load and leakage);
- TRMS voltage, frequency, phase sequence;
- Power, energy, harmonics.

### KEY FEATURES

#### Photovoltaic installations:

- **Calculation of STC values:** the measured current and voltage values are, according to environment conditions, recalculated to Standard Test Condition values which makes possible, to compare the results

even if they were taken under different test conditions.

- **Graphical representation:** the I-V characteristic of PV module or string is graphically represented on LCD display.
- **Power and efficiency measurements:** 2 voltage & 2 current channels for simultaneous AC & DC parameters measurements.
- **PV Remote Unit:** Optional unit for simultaneous measurements of solar irradiation and temperature of PV module.

#### Electrical installations

- **RCD Auto:** Automated RCD testing procedure significantly reduces test time.
- **Trip Lock function:** Loop impedance test are performed without tripping the RCD.
- **B type RCD testing:** is supported.
- Earth resistance measurement: instrument supports 3-wire earth resistance testing.
- **Built-in fuse tables:** for automatic evaluation of the line / loop impedance results.
- **Online voltage monitoring:** monitors all 3 voltages in real time.
- **Scope function:** real-time U/I scope.
- **Harmonics analysis:** 1-phase power and energy measurements with up to 11th harmonics analysis is supported.
- **Memory:** Up to 1800 test results or up to 500 graphical results with timestamp can be stored in internal memory.
- **BT connectivity:** it enables BT communication with Android tablets and

smart phones via optional BT dongle.

- **Android application:** enables advanced data management APP EuroLink PV and EuroLink Android.
- PC SW **EuroLink PRO** enables downloading, uploading, review, analyses and printing of test results.

### APPLICATION

- Testing, evaluations and troubleshooting of photovoltaic installations.
- Power and energy efficiency measurements (AC and DC).
- Initial and periodic testing of domestic and industrial single and three-phase electrical installations.

### STANDARDS

#### Functionality:

- IEC/EN 61557 series;
- IEC 62446 (photovoltaics);
- IEC 61829.

#### Other reference standards for testing:

- BS 7671;
- EN 61008;
- EN 61009;
- EN 60364-4-41;
- AS/NZ 3017

#### Electromagnetic compatibility:

- EN 61326

#### Safety:

- EN 61010-1;
- EN 61010-2-030;
- EN 61010-031;
- EN 61010-2-032

## TECHNICAL DATA

### PHOTOVOLTAIC INSTALLATION MEASUREMENTS

Function	Measuring range	Basic accuracy
Voltage	0 VDC ... 999 VDC 0 VAC ... 999 VAC I-V m.: 0 VDC ... 999 VDC	±(1 % of reading + 2 digits) ±(1.5 % of reading + 3 digits) ±(1 % of reading + 2 digits)
Current	Panel m.: 0.0 mA ... 300 ADC Invert. m.: 0.0 mA ... 300 AAC I-V m.: 0.00 A ... 15 ADC	±(1 % of reading + 2 digits) ±(1.5 % of reading + 3 digits) ±(1 % of reading + 2 digits)
Power	Panel m.: 0 ... 999 kW I-V m.: 0 ... 14.99 kW	±(2.5 % of reading + 6 digits) ±(2 % of reading + 3 digits)
U / I curve	1000 V / 15 A / 15 kW	
Irradiation	000 ... 1.75 kW/m <sup>2</sup>	±(4 % of reading + 5 digits)
Temperature	-10.0 °C ... + 85.0 °C	± 5 digits

### ELECTRICAL INSTALLATION MEASUREMENTS

Function	Measuring range	Basic accuracy
Insulation resistance (EN 61557-2)	U = 50, 100, 250 VDC: R: up to 199.9 MΩ U = 500 VDC, 1 kVDC: R: up to 999 MΩ	±(5 % of reading + 3 digits) ±(5 % of reading + 3 digits)
Continuity, 200 mA (EN 61557-4)	0.00 Ω ... 1999 Ω	±(3 % of reading + 3 digits)
Continuity, 7 mA	0.0 Ω ... 1999 Ω	±(5 % of reading + 3 digits)
Loop impedance (EN 61557-3)	0.00 Ω ... 9.99 kΩ	±(5 % of reading + 5 digits)
Line impedance (EN 61557-3)	0.00 Ω ... 9.99 kΩ	±(5 % of reading + 5 digits)
Voltage	0 VAC ... 550 VAC	±(2 % of reading + 2 digits)
Frequency	0.00 Hz ... 499.9 Hz	±(0.2 % of reading + 1 digits)
Phase sequence (EN 61557-7)	1.2.3 or 3.2.1	
RCD testing (EN 61557-6)	IΔN: 10 mA, 30 mA, 100 mA, 300 mA, 500 mA, 1 A	
Contact voltage UC	0.0 V ... 99.9 V	(-0 % / +15 %) of reading
Trip-out time	0 ms ... 40 ms	±1 ms
Trip-out current	0.2 x IΔN ... 2.2 x IΔN	±0.1 x IΔN
Earth resistance (EN 61557-5)	0.00 Ω ... 9999 Ω	±(5 % of reading + 5 digits)
Energy	0.000 Wh - 1999 kWh	
Harmonics	up to 11th	

General	Main unit	Remote unit
Display	128 x 64 dots matrix display with backlight	128 x 64 dots matrix display with backlight
Power supply	6 x 1.2 V NiMH batteries, type AA	6 x 1.2 V NiMH batteries, type AA
Overvoltage category	CAT II / 1000 VDC; CAT III / 600 V; CAT IV / 300 V	
Protection class	double insulation	
COM port	RS232 and USB	RS232
Dimensions	230 x 103 x 115 mm	140 x 230 x 80 mm
Weight	1.3 kg	1.0 kg

### STANDARD SET

#### MI 3108 ST

- Instrument MI 3108 EurotestPV
- A 1552 Large carrying bag
- A 1053 Schuko-plug test cable
- A 1193 Test lead, 3 x 1.5 m
- A 1016, A 1062, A 1015, A 1014 Test probe, 4 pcs (red, green, blue, black)
- A 1064, A 1309, A 1310, A 1013 Crocodile clip, 4 pcs (red, green, blue, black)
- A 1384 PV Safety Probe
- S 2145 PV MC3/4 male/female adapters
- A 1427 PV Reference Cell
- A 1400 Temperature probe

- A 1707 Set of carrying straps
- USB and RS232 - PS/2 cable
- Power supply adapter + 6 NiMH batteries, type AA
- PC SW EuroLink PRO
- Short instruction manual
- Instruction manual and handbook on storage media
- Calibration certificate

#### MI 3108 PS

- MI 3108 ST
- A 1378, A 1414 EurotestPV Remote
- A 1401 Tip commander
- PC SW EuroLink PRO Plus licence



Picture of MI 3108 PS set

# Photovoltaic and electrical installations tester

## MI 3109 EurotestPV Lite



MI 3109 EurotestPV Lite is a photovoltaic (PV) tester. It performs all necessary tests required on photovoltaic installations. This includes all of the tests as required by EN 62446, but also includes I - U characteristic measurements, calculation of STC values as required by EN 61829 and power measurements on Inverter's DC and AC sides (single-phase only). MI 3109 EurotestPV Lite is optimized for PV tests therefore the Autotest operation mode is implemented which is intended to perform a complete set of test needed for verification of PV installations according to EN 62446 with pressing off only one button. With this instrument the tests for the first inspection of PV systems as well as periodic maintenance tests, evaluation tests or troubleshooting tests are possible. With optional accessories the same PV test functionality as with MI 3108 EurotestPV is available.



### MEASURING FUNCTIONS

#### Photovoltaic installations:

##### • Measurements on DC side of PV installation:

- Insulation resistance;
- Continuity of PE conductors;
- Uoc (Open Circuit Voltage) and Isc (Short Circuit Current);
- I - U curve of PV modules and strings;
- Voltage, current and power of strings and inverters;
- Irradiance;
- Module temperature.

##### • Measurements on AC side of PV installation:

- Voltage, current, power;
- Efficiency of PV module, inverter, PV system calculation.

### KEY FEATURES

- **Insulation and I-U curve measurements in one instrument:** with MI 3109 only one instrument is needed to perform insulation measurements with up to 1000V for proofing the PV installation safety and I-U curve measurements needed for evaluation and troubleshooting of PV modules or strings.
- **Autotest:** This function is intended to perform a complete set of tests according to EN 62446 on PV modules or strings with pressing only one button:
- insulation resistance between positive output and earth;

- insulation resistance between negative output and earth;
- open circuit voltage;
- short circuit current.
- **Calculation to STC values:** the measured current and voltage values are, according to environment conditions, recalculated to Standard Test Condition values which makes possible to compare the results of different measurements even if they were taken under different test conditions.
- **Efficiency calculations:** 2 voltage & 2 current channels for simultaneous AC & DC parameters measurements.
- **PV Remote Unit:** Optional unit for simultaneous measurements of solar irradiation and temperature of PV module.
- **Graphical representation of module's I - U curve:** the I-V characteristic of PV module or string is graphically represented on LCD display.
- **Memory:** Up to 1800 test results or up to 500 graphical results with timestamp can be stored in internal memory.
- **BT connectivity:** it enables BT communication with Android tablets and smart phones via optional BT dongle.
- **Android application:** enables advanced data management APP EuroLink PV.
- PC SW **EuroLink PRO** enables downloading, uploading, review, analyses and printing of test results.

### APPLICATION

- First inspection Testing.
- Periodic maintenance tests.
- Evaluation and troubleshooting of photovoltaic installations.
- Power and efficiency measurements (AC and DC).

### STANDARDS

#### Functionality:

- IEC/EN 61557 series;
- IEC 62446 (photovoltaics);
- IEC 61829.

#### Electromagnetic compatibility:

- EN 61326

#### Safety:

- EN 61010-1;
- EN 61010-2-030;
- EN 61010-031;
- EN 61010-2-032



## TECHNICAL DATA

### PHOTOVOLTAIC INSTALLATION MEASUREMENTS

Function	Measuring range	Basic accuracy
Voltage	0 VDC ... 999 VDC	±(1 % of reading + 2 digits)
	0 VAC ... 999 VAC	±(1.5 % of reading + 3 digits)
	I-V m.: 0 VDCC ... 999 VDC	±(1 % of reading + 2 digits)
Current	Panel m.: 0.0 mA ... 300 ADC	±(1 % of reading + 2 digits)
	Invert. m.: 0.0 mA ... 300 AAC	±(1.5 % of reading + 3 digits)
	I-V m.: 0.00 A ... 15 ADC	±(1 % of reading + 2 digits)
Power	Panel m.: 0 ... 199.9 kW	±(2.5 % of reading + 6 digits)
	I-V m.: 0 ... 14.99 kW	±(2 % of reading + 3 digits)
U / I curve	1000 V / 15 A / 15 kW	
Irradiation	000 ... 1.75 kW/m <sup>2</sup>	±(4 % of reading + 5 digits)
Temperature	-10.0 °C ... + 85.0 °C	± 5 digits

### ELECTRICAL INSTALLATION MEASUREMENTS

Function	Measuring range	Basic accuracy
Insulation resistance (EN 61557-2)	U = 50, 100, 250 VDC: R: up to 199.9 MΩ	±(5 % of reading + 3 digits)
	U = 500 VDC, 1 kVDC: R: up to 999 MΩ	±(5 % of reading + 3 digits)
Continuity, 200 mA (EN 61557-4)	0.00 Ω ... 1999 Ω	±(3 % of reading + 3 digits)
Continuity, 7 mA	0.0 Ω ... 1999 Ω	±(5 % of reading + 3 digits)

General	Main unit	Remote unit
Display	128 x 64 dots matrix display with backlight	128 x 64 dots matrix display with backlight
Power supply	6 x 1.2 V NiMH batteries, type AA	6 x 1.2 V NiMH batteries, type AA
Overvoltage category	CAT II / 1000 VDC; CAT III / 600 V; CAT IV / 300 V	
Protection class	double insulation	
COM port	RS232 and USB	RS232
Dimensions	230 x 103 x 115 mm	140 x 230 x 80 mm
Weight	1.3 kg	1.0 kg

### STANDARD SET

#### MI 3109 ST

- Instrument MI 3109 EurotestPV Lite
- A 1289 Soft carrying bag
- A 1411 Universal PV test lead, 3 x 1.5 m
- A 1412 PV Continuity test lead, 2 x 1.5 m
- A 1016, A 1015, A 1062 Test probe, 3 pcs (red, blue, green)
- A 1064, A 1310, A 1309 Crocodile clip, 3 pcs (red, blue, green)
- S 2145 PV MC3/4 male/female adapters
- Power supply adapter + 6 NiMH batteries, type AA
- USB and RS232 - PS/2 cable

- PC SW EuroLink PRO
- A 1707 Carrying strap
- Short instruction manual
- Instruction manual and handbook on storage media
- Calibration certificate

#### MI 3109 PS



- MI 3109 ST
- A 1378, A 1414 EurotestPV Remote
- A 1384 PV Safety Probe
- A 1427 PV Reference Cell
- A 1400 Temperature probe
- A 1552 Soft carrying bag
- PC SW EuroLink PRO Plus licence



Picture of MI 3109 PS set

# Single-functional Testers

## Selection Guide for Single-functional Testers

FEATURES	Description	MI 3121 Insulation / Continuity	MI 3122 Z Line-Loop / RCD
			
<b>INSULATION</b>	Insulation resistance	•	
	Test voltage (VDC)	50 ... 1000	
	Insulation resistance measuring range	up to 30 GΩ	
<b>CONTINUITY AND LOW RESISTANCE MEASUREMENT</b>	Continuity of PE conductor with automatic polarity change, test current 200mA	•	
	Low resistance measurement (continuous measurement), test current 7 mA.	•	
<b>LINE / LOOP IMPEDANCE</b>	Line impedance with Ipsc calculation		•
	Loop impedance with Ipsc calculation		•
	RCD Trip Lock loop impedance		•
	Built-in fuse tables for PASS / FAIL evaluation		•
<b>RCD TESTING</b>	Contact voltage without RCD tripping		•
	RCD trip-out time		•
	RCD trip-out current with rising test current		•
	Automatic testing of RCDs		•
	RCD type (general and selective)		AC / A
<b>VOLTAGE, FREQUENCY</b>	AC voltage measurement	•	
	Online voltage monitor		•
	Frequency measurement	•	•
<b>PHASE SEQUENCE</b>	L1 - L2 - L3		•
<b>EARTH, CURRENT MEASUREMENTS</b>	Earth resistance 3-(4-)wire method		
	Earth resistance 3-(4-)wire method with additional current clamp		
	Earth resistance measurement with 2 current clamps		
	Specific earth resistance		
	TRMS current		
	TRMS leakage / load current		
<b>IT EARTHING SYSTEM SPECIFIC MEASUREMENTS</b>	Insulation Monitoring Devices (IMD) testing (IT systems)		
	First fault leakage current (ISFL) measurement (IT systems)		
	Predefined mini Autosequences		
<b>OTHER FEATURES</b>	Varistor test		
	Nominal frequency range	15 Hz ... 500 Hz	15 Hz ... 500 Hz
	PASS / FAIL evaluation of test results	•	•
	Touch electrode		•
	Help menu		•
<b>COMMUNICATION PORTS</b>	RS232	•	•
	USB	•	•
<b>MEMORY, SOFTWARE</b>	Memory	•	•
	Number of memory levels / memory locations	2 / 1500	3 / 1500
	Professional PC SW	Option	Option
	Advanced PC SW	Option	Option
<b>GENERAL DATA</b>	Safety category	CAT III / 600 V CAT IV / 300 V	CAT III / 600 V CAT IV / 300 V
	Batteries	6 x AA	6 x AA
	Built-in battery charger	•	•
	Weight	850 g	930 g
	Dimensions (mm)	140 x 80 x 230	140 x 80 x 230

<b>MI 3123 Earth / Clamp</b>	<b>MI 3110 EurotestIM</b>
----------------------------------	-------------------------------



	•
	•
	•
	•
	•
	•
	•
•	
Option	
Option	
•	
Option	
	•
	•
	•
40 Hz ... 500 Hz	14 Hz ... 500 Hz
•	•
•	
•	•
•	•
•	•
3 / 1500	3 / 500
Option	•
Option	Option
CAT IV / 50 V	CAT III / 600 V CAT IV / 300 V
6 x AA	6 x AA
•	•
850 g	1.31
140 x 80 x 230	230 x 103 x 115

# Single-functional testers

## MI 3121 SMARTEC Insulation / Continuity



The MI 3121 SMARTEC Insulation / Continuity is a new generation tester for dead testing of electrical installations. With both an analogue and digital representation of the results, the instrument ensures accurate measurements up to 2000  $\Omega$  on continuity and up to 30 G $\Omega$  on insulation function. Configurable limits enable a PASS / FAIL evaluation of test results, which is accompanied with the bright red and green indicator lights for comfortable use even in the dark conditions. The MI 3121 is equipped with a built-in charger and has a magnetic holder in order to free up hands for testing. All the results can be quickly saved on the instrument and then downloaded via the optional A 1291 EuroLink PRO or A 1290 EuroLink PRO Plus software for evaluation and professional report generation after testing. The MI 3121 SMARTEC Insulation / Continuity performs continuity, insulation AC voltage and frequency measurement tests.

### MEASURING FUNCTIONS

- Insulation resistance with DC voltage;
- Continuity of PE conductors with 200 mA test current with polarity change;
- Continuity of PE conductors with 7 mA test current (continuous measurement) without RCD tripping;
- TRMS voltage and frequency.

### KEY FEATURES

- **Insulation range:** wide range of insulation test voltages from 50 V to 1000 V, measuring range up to 30 G $\Omega$ .
- **Analogue scale and digital LCD:** measuring results are displayed both in numeric and analogue representation.
- **Downloadable:** downloads via RS232 or USB cable directly to the PC with the help of the optional software.

- **Upgradeable:** if changes occur to the regulations upgrades can be made to the firmware to keep the instrument up to date.
- **Polarity swap:** automatic polarity reversal on continuity test.
- **Built-in charger & rechargeable batteries:** instrument has a built-in charging circuit and comes complete with a set of rechargeable NiMH batteries.
- **Custom limits:** if limits are set on insulation or continuity function then large green and red lights of the LEDs will indicate a PASS or FAIL evaluation of test result.
- **Easy to use:** large bright LCD display and large buttons enable easy handling of the instrument (even while wearing gloves).
- **Magnetic holder:** magnet for fixing instrument on metal surfaces enables hands-free operation.

### APPLICATION

- Domestic dead circuit testing;
- Industrial dead circuit testing;
- Telecommunication systems testing;
- Resistance measurements.

### STANDARDS

#### Functionality:

- IEC/EN 61557

#### Other reference standards for testing:

- IEC/EN/HD 60364;
- AS/NZ 3018;
- CEI 64.8;
- HD 384;
- BS 7671;
- VDE 0413

#### Electromagnetic compatibility:

- IEC/EN 61326-1;
- IEC/EN 61326-2-2

#### Safety:

- IEC/EN 61010-1;
- IEC/EN 61010-031

## TECHNICAL DATA

FUNCTION	Measuring range	Resolution	Accuracy
Insulation resistance (EN 61557-2)	U = 500, 1000 VDC:		
	R: 0.00 MΩ ... 19.99 MΩ	0.01 MΩ	±(5 % of reading + 3 digits)
	20.0 MΩ ... 199.9 MΩ	0.1 MΩ	±5 % of reading
	200 MΩ ... 999 MΩ	1 MΩ	±5 % of reading
	1.00 GΩ ... 4.99 GΩ	10 MΩ	±10 % of reading
	5.00 GΩ ... 19.99 GΩ	10 MΩ	±20 % of reading
	20.0 GΩ ... 29.9 GΩ	100 MΩ	Indicator only
	U = 50, 100, 250 VDC:		
	R: 0.00 MΩ ... 19.99 MΩ	0.01 MΩ	±(5 % of reading + 3 digits)
	20.0 MΩ ... 99.9 MΩ	0.1 MΩ	±10 % of reading
100.0 MΩ ... 199.9 MΩ	0.1 MΩ	±20 % of reading	
Continuity 200 mA of PE conductor with polarity change (EN 61557-4)	0.00 Ω ... 19.99 Ω	0.01 Ω	±(3 % of reading + 3 digits)
	20.0 Ω ... 199.9 Ω	0.1 Ω	±5 % of reading
	200 Ω ... 1999 Ω	1 Ω	±10 % of reading
Low resistance measurement with 7 mA test current (continuous measurement)	0.0 Ω ... 19.9 Ω	0.1 Ω	±(5 % of reading + 3 digits)
	20 Ω ... 1999 Ω	1 Ω	±10 % of reading
Voltage	0.0 V ... 99.9 V	0.1 V	±(3 % of reading + 3 digits)
	100 V ... 550 V	1 V	
Frequency	0.00 Hz ... 19.99 Hz	0.01 Hz	±(0.2 % of reading + 1 digits)
	20.0 Hz ... 199.9 Hz	0.1 Hz	
	200 Hz ... 500 Hz	1 Hz	
Power supply	6 x 1.2 V rechargeable batteries, type AA		
Overvoltage category	CAT III / 600 V; CAT IV / 300 V		
Protection class	Double insulation		
COM port	RS232 and USB		
Dimensions	140 x 230 x 80 mm		
Weight	0.85 kg		

### STANDARD SET

#### MI 3121

- Instrument Smartec Insulation / Continuity
- Soft hand strap
- Test lead, 2 x 1.5 m
- Test probe, 2 pcs (black, red)
- Crocodile clip, 2 pcs (black, red)
- Power supply adapter + 6 NiMH rechargeable batteries, type AA
- Instruction manual on storage media

- Short instruction manual
- Handbook on storage media
- Calibration certificate



Picture of MI 3121 set

# Single-functional testers

## MI 3122 SMARTEC Z Line-Loop / RCD



The MI 3122 SMARTeC Z Line-Loop / RCD is designed specifically for live circuit testing. The instrument contains integrated characteristics of fuses and RCDs for the evaluation of test results. The online voltage monitoring system allows the operator to control what is happening on three simultaneous voltages in real-time. The bright red and green PASS / FAIL lights and help screens for each measurement make the handling of the instrument easy and clear. All the results can be quickly saved on the instrument and then downloaded via the optional A 1291 EuroLink PRO or A 1290 EuroLink PRO Plus software for evaluation and professional report generation after testing. The MI 3122 SMARTeC Z Line-Loop / RCD performs RCD, loop, line, AC voltage, frequency and phase sequence tests required by the EN 61557 standard.

### MEASURING FUNCTIONS

- Line impedance;
- Loop impedance;
- Loop impedance with Trip Lock RCD function;
- TRMS voltage and frequency;
- Phase sequence;
- RCD testing (general and selective, type AC and A).

### KEY FEATURES

- **Help screens:** instrument comes complete with built-in help screens for referencing on site.
- **LED Pass/Fail indicators:** two LED indicators for PASS / FAIL evaluation of test results are placed on both sides of the LCD.
- **Built-in fuse tables:** this unique feature allows automatic evaluation of the line / loop impedance compared to the regulations.

- **Online voltage monitoring:** monitors all 3 voltages in real-time.
- **Downloadable:** downloads via RS232 or USB cable directly to the PC with the help of the optional software.
- **Upgradeable:** if changes occur to the regulations upgrades can be made to the firmware to keep the instrument up to date.
- **Trip Lock function:** Zs (RCD) function performs a loop impedance test without tripping the RCD.
- **Built-in charger & rechargeable batteries:** instrument has a built-in charging circuit and comes complete with a set of rechargeable NiMH batteries.
- **RCD auto:** automated RCD testing procedure significantly reduces test time.
- **Easy to use:** large bright LCD display and large buttons enable easy handling of the instrument (even while wearing gloves).
- **Magnetic holder:** magnet for fixing instrument on metal surfaces enables hands-free operation.

### APPLICATION

- Domestic and Industrial live circuit testing;
- Testing of single phase and 3-phase, TT and TN systems.

### STANDARDS

#### Functionality:

- IEC/EN 61557

#### Other reference standards for testing:

- IEC/EN/HD 60364;
- IEC/EN 61008;
- IEC/EN 61009;
- IEC/EN/TR 60755;
- AS/NZ 3760;
- AS/NZ 3018;
- CEI 64.8;
- HD 384;
- BS 7671;
- VDE 0413

#### Electromagnetic compatibility:

- IEC/EN 61326-1;
- IEC/EN 61326-2-2

#### Safety:

- IEC/EN 61010-1;
- IEC/EN 61010-031

## TECHNICAL DATA

FUNCTION	Measuring range	Resolution	Accuracy
RCD testing (EN 61557-6)	I $\Delta$ N: 10 mA, 30 mA, 100 mA, 300 mA, 500 mA, 1 A		
- Scaling factor for I $\Delta$ N	x 0.5; x 1; x 2; x 5		
- Contact voltage UC	0.0 V ... 19.9 V 20.0 V ... 99.9 V	0.1 V 0.1 V	(-0%/+15%) of reading $\pm$ 10 digits (-0%/+15%) of reading
- Trip-out current	(0.2 ... 1.1) x I $\Delta$ N (AC type) (0.2 ... 1.5) x I $\Delta$ N (A type, I $\Delta$ N $\geq$ 30 mA) (0.2 ... 2.2) x I $\Delta$ N (A type, I $\Delta$ N < 30 mA)	0.05 x I $\Delta$ N 0.05 x I $\Delta$ N 0.05 x I $\Delta$ N	$\pm$ 0.1x I $\Delta$ N $\pm$ 0.1x I $\Delta$ N $\pm$ 0.1x I $\Delta$ N
- Trip-out time	0.0 ms ... 40.0 ms 0.0 ms ... max. time	0.1 ms 0.1 ms	$\pm$ 1 ms $\pm$ 3 ms
Loop impedance (EN 61557-3)	0.00 $\Omega$ ... 9.99 $\Omega$ 10.0 $\Omega$ ... 99.9 $\Omega$ 100 $\Omega$ ... 999 $\Omega$ 1.00 k $\Omega$ ... 9.99 k $\Omega$	0.01 $\Omega$ 0.1 $\Omega$ 1 $\Omega$ 10 $\Omega$	$\pm$ (5 % of reading + 5 digits) $\pm$ (5 % of reading + 5 digits) $\pm$ 10 % of reading $\pm$ 10 % of reading
Line impedance (EN 61557-3)	0.00 $\Omega$ ... 9.99 $\Omega$ 10.0 $\Omega$ ... 99.9 $\Omega$ 100 $\Omega$ ... 999 $\Omega$ 1.00 k $\Omega$ ... 9.99 k $\Omega$	0.01 $\Omega$ 0.1 $\Omega$ 1 $\Omega$ 10 $\Omega$	$\pm$ (5 % of reading + 5 digits) $\pm$ (5 % of reading + 5 digits) $\pm$ 10 % of reading $\pm$ 10 % of reading
Voltage	0 V ... 550 V	1 V	$\pm$ (2 % of reading + 2 digits)
Frequency	15.0 Hz ... 499.9 Hz	0.1 Hz	$\pm$ (0.2 % of reading + 1 digit)
Phase sequence (EN 61557-7)	1.2.3 or 3.2.1		
Power supply	6 x 1.2 V rechargeable batteries, type AA		
Overvoltage category	CAT III / 600 V; CAT IV / 300 V		
Protection class	Double insulation		
COM port	RS232 and USB		
Dimensions	140 x 230 x 80 mm		
Weight	0.93 kg		

### STANDARD SET

#### MI 3122

- Instrument Smartec Z Line - Loop / RCD
- Soft hand strap
- Schuko-plug test cable
- Test lead, 3 x 1.5 m
- Test probe, 3 pcs (blue, black, green)
- Crocodile clip, 3 pcs (blue, black, green)
- Power supply adapter + 6 NiMH rechargeable batteries, type AA

- Instruction manual on storage media
- Short instruction manual
- Handbook on storage media
- Calibration certificate



Picture of MI 3122 set

# Single-functional testers

## MI 3123 SMARTEC Earth / Clamp



The MI 3123 SMARTEC Earth / Clamp is a new generation earth resistance tester with the ability to perform 4-wire earth resistance measurement and 4-wire specific earth resistance measurement. With the optional A 1018 and A 1019 current clamps the instrument can perform 4-wire earth resistance measurement with one current clamp, contactless earth resistance testing with two clamps and TRMS current measurement up to 20 A. Configurable limits enable a PASS / FAIL evaluation of test results. All the results can be saved on the instrument and then downloaded via the optional software for evaluation and professional report generation after testing. The lightweight design, large bright LCD screen, built-in help screens, optional downloading via RS232 or USB ports and overvoltage category CAT IV make the MI 3123 an incredible earth resistance measuring instrument.

### MEASURING FUNCTIONS

- Earth resistance, 4-wire method;
- Earth resistance, 4-wire method with one current clamp (option);
- Earth resistance, two clamps method (option);
- Specific earth resistance;
- TRMS current (option).

### KEY FEATURES

- **Earth resistance measurement:** instrument performs standard 4-wire earth resistance tests with two earthing rods and specific earth resistance measurement.
- **Selective earth resistance test:** optional 4-wire earth resistance measurement in combination with an additional current clamp is used for measuring earth resistance of individual earthing rods.
- **Contactless earth resistance test:** earth resistance measurement with 2 current clamps without breaking the

loop is intended for measuring resistance of individual earthing rods and is recommended first of all for urban areas.

- **Downloadable:** downloads via RS232 or USB cable directly to the PC with the help of the optional software.
- **Upgradeable:** if changes occur to the regulations upgrades can be made to the firmware to keep the instrument up to date.
- **Help screens:** instrument comes complete with built-in help screens for referencing on site.
- **Built-in charger & rechargeable batteries:** instrument has a built-in charging circuit and comes complete with a set of rechargeable NiMH batteries.
- **Custom limits:** the limits can be set on any function, in that case large green and red lights of the LEDs will indicate a PASS or FAIL evaluation of test result.
- **Easy to use:** large bright LCD display and large buttons enable easy handling of the instrument (even while wearing gloves).
- **Magnetic holder:** magnet for fixing instrument on metal surfaces enables hands-free operation.

### APPLICATION

- Testing on TT and IT systems;
- Testing sub-station earthing;
- Lightning system testing.

### STANDARDS

#### Functionality:

- IEC/EN 61557

#### Other reference standards for testing:

- IEC/EN/HD 60364;
- AS/NZ 3018;
- CEI 64.8;
- HD 384;
- BS 7671;
- VDE 0413

#### Electromagnetic compatibility:

- IEC/EN 61326-1;
- IEC/EN 61326-2-2

#### Safety:

- IEC/EN 61010-1;
- IEC/EN 61010-031;
- IEC/EN 61010-2-032



## TECHNICAL DATA

FUNCTION	Measuring range	Resolution	Accuracy
Earth resistance (4-wire method (EN 61557-5); 4-wire method with one current clamp)	0.00 Ω ... 19.99 Ω	0.01 Ω	±(3 % of reading + 3 digits)
	20.0 Ω ... 199.9 Ω	0.1 Ω	±(3 % of reading + 3 digits)
	200 Ω ... 1999 Ω	1 Ω	±5 % of reading
	2000 Ω ... 9999 Ω	1 Ω	±10 % of reading
Earth resistance (2 clamps method)	0.00 Ω ... 19.99 Ω	0.01 Ω	±(10 % of reading + 10 digits)
	20.0 Ω ... 30.0 Ω	0.1 Ω	±20 % of reading
	30.1 Ω ... 99.9 Ω	0.1 Ω	±30 % of reading
Specific earth resistance (EN 61557-5)	0.0 Ωm ... 99.9 Ωm	0.1 Ωm	Calculated value, consider earth resistance 4-wire method
	100 Ωm ... 999 Ωm	1 Ωm	
	1.00 kΩm ... 9.99 kΩm	0.01 kΩm	
	10.0 kΩm ... 99.9 kΩm	0.1 kΩm	
	>100 kΩm	1 kΩm	
TRMS Current	0.0 mA ... 99.9 mA	0.1 mA	±(3 % of reading + 3 digits)
	100 mA ... 999 mA	1 mA	
	1.00 A ... 19.99 A	0.01 A	
Power supply	6 x 1.2 V rechargeable batteries, type AA		
Overvoltage category	CAT IV / 50 V		
Protection class	Double insulation		
COM port	RS232 and USB		
Dimensions	140 x 230 x 80 mm		
Weight	0.85 kg		

### STANDARD SET

#### MI 3123

- Instrument Smartec Earth / Clamp
- Soft hand strap
- Test lead, 4.5 m (blue)
- Test lead, 4.5 m (red)
- Test lead, 20 m (green)
- Test lead, 20 m (black)
- Earth test rod, 4 pcs
- Power supply adapter + 6 NiMH rechargeable

- batteries, type AA
- Instruction manual on storage media
- Short instruction manual
- Handbook on storage media
- Calibration certificate



Picture of MI 3123 set

# Single-functional testers

## MI 3110 EurotestIM



The MI 3110 EurotestIM is a perfect tool for testing of permanent integrated or portable Low Voltage Electrical Installations supplied by Generator or Transformer and protected by an IT earthing system. Designed for simple but efficient safety testing of Integrated IT Earthing System powered with LV Generator or Transformer! With a single, pre-programmed AUTO SEQUENCE<sup>®</sup> with sub-tests and adjustable limits it is possible to perform all the necessary verifications of safety limits of a specific LV IT installation.

### MEASURING FUNCTIONS

- Voltage, frequency and phase sequence.
- Line impedance and prospective short circuit current.
- Voltage drop.
- First fault leakage current (ISFL).
- Testing of insulation monitoring devices (IMD).

### KEY FEATURES

- **AUTO SEQUENCE<sup>®</sup>**: One single AUTO SEQUENCE<sup>®</sup> with programmable limits and sub-tests ensuring Safety on all PASS barrier parameters.
- **Voltage monitor**: IT System recognizing, Voltage Range and Voltage Balance.
- **ISFL test**: ISFL Single Fault Leakage current from Phase 1 and Phase 2 to PE. Fuse Trip-out Ability Evaluation, Line Impedance and Ipsc Prospective Short Circuit Current.
- **IMD control**: IMD Insulation / ELM Earth Leakage / RCM Residual Current Monitor Devices Control.
- **IMD adjust**: Alarm Trigger or Trip-Out Check and Adjust.

### APPLICATION

- Safety and functionality on IT installations in industry, in hospitals;
- Connection of portable power generators;
- Firefighting mobile equipment, generators and pumps;
- Military vehicles and generators;
- Police vehicles and generators;
- Construction sites and Road maintenance;
- SAT and radio / TV broadcasting mobile equipment;
- Safety and functionality on IT installations on the airports, concert halls, fair locations with generators;
- Marines and ships;
- Mines, other special locations;
- Adjustment and calibrations of IMD devices.

### STANDARDS

#### Functionality:

- IEC/EN 61557

#### Other reference standards for testing:

- EN 60364-4-41;
- BS 7671;
- AS/NZS 3017

#### Electromagnetic compatibility:

- IEC/EN 61326-1;
- IEC/EN 61326-2-2

#### Safety:

- IEC/EN 61010 -1;
- EN 61010-2-030;
- EN 61010-031

## TECHNICAL DATA

FUNCTION	Measuring range	Resolution	Accuracy
Voltage	0 V ... 550 V	1 V	±(2 % of reading + 2 digits)
Frequency	0.00 Hz ... 9.99 Hz 10.0 Hz ... 499.9 Hz	0.01 Hz 0.1 Hz	±(0.2 % of reading + 1 digit)
Phase sequence (EN 61557-7)	1.2.3 or 3.2.1		
Line impedance (EN 61557-3)	0.00 Ω ... 9.99 Ω 10.0 Ω ... 99.9 Ω	0.01 Ω 0.1 Ω	±(5 % of reading + 5 digits)
Prospective short-circuit current	0.00 A ... 0.99 A 1.0 A ... 99.9 A 100 A ... 999 A 1.00 kA ... 99.99 kA 100 kA ... 199 kA	0.01 A 0.1 A 1 A 10 A 1000 A	Consider accuracy of line resistance measurement
First fault leakage current (ISFL)	0.0 mA ... 19.9 mA	0.1 mA	±(5 % of reading + 3 digits)
Threshold indicative insulation resistance	5 kΩ ... 640 Ω	5 kΩ	Indicative values Up to 128 steps
Power supply	6 x 1.2 V rechargeable batteries, type AA		
Overvoltage category	CAT III / 600 V; CAT IV / 300 V		
Protection class	Double insulation		
Dimensions	230 x 103 x 115 mm		
Weight	1.1 kg		

### STANDARD SET

#### MI 3110

- Instrument EurotestIM
- Soft carrying bag
- Mains measuring cable
- Test lead, 3 x 1.5 m
- Test probe, 3 pcs
- Crocodile clip, 3 pcs
- Set of carrying straps
- RS232-PS/2 cable
- USB cable

- Set of NiMH battery cells
- Power supply adapter
- PC software EuroLink PRO
- Short instruction manual
- Instruction manual on storage media
- Handbook on storage media
- Calibration Certificate



Picture of MI 3110 set

# Other instruments / adapters / accessories

## MI 3144 Euro Z 800 V



The MI 3144 Euro Z 800 V is a Multi-function, portable battery (Li-ion) or mains powered test instrument with excellent IP protection: IP65 (case closed), IP54 (case opened). It can be controlled via an Android app aMESM, MI 3152, MI 3152H, MI 3155 or MI 3325. The MI 3144 Euro Z 800 V is intended for measuring the effectiveness of automatic trip out protection in case of faults in transformers and other HV equipment. With its high precision line and loop impedances on AC and DC circuits, high current dR 300A loop and line measurements for testing of partial currents and partial voltage drops, contact voltage measurement, ELR electrical leakage relay testing with fault current injection and trip-out time measurement and DC Source, accumulator, battery, DC lines and circuit measurement it is ideal for testing in industrial settings.

### KEY FEATURES

- **Hi Precision 4-wire 300A Z Line and Z Loop Impedance Tester;**
- **Hi Range impedance measurements in 800 V / 16 ... 420 Hz AC networks;**
- **DC Source & Line Resistance measurements in 3 ... 260 V DC networks;**
- Hi Current dR 300A 4-wire **Partial Voltage drops** and **Current's Path Resistances;**
- **Earth Leakage Relay (ELR) Trip-out Testing Time and Current;**
- ELR supported types AC, A, B;
- **Ground Fault Analysis** with Contact, Touch and Step Voltage;
- Floating Voltmeter for partial contact results;
- **One-Clamp Hi Current Grounding method** with clamps (Flex & Iron);
- **Selectable test load** (16.6 % to 100 %);
- Improved thermal performance;
- Portable battery (Li-ion) or mains powered test instrument;
- IP protection: IP65 (case closed), IP54 (case opened);
- **CAT IV 600V (3000 m) safety category;**
- Bluetooth communication;
- Remote controlled with supported Metrel safety testers or aMESM.

### APPLICATION

- Live Power Transformer Hi Precision 4-wire 300A Z Line / Loop Impedance Testing.
- Partial Voltage Drops and Partial Clamp Current's Path Resistances.
- Airports High Frequency Band 16 ... 420 Hz Installation Impedances testing.
- DC Networks' and Power Sources' Line and Loop Resistances.
- Flex & Iron One-Clamp High Current dR 300A Grounding method for Lightning systems.
- High Current dR 300A Integrity of Grounding system with Flex and Iron One-Clamp method.
- ELR (MRCD) trip-out Current and trip-out Time testing.
- Earth Potentials by method of measuring Step, Touch and Transfer voltages.
- Automatic trip-out protection evaluation in case of faults in transformers, generators, turbines, contactors, distribution boards and switchyards whenever energetic loads and sources of protection exceed 200A.
- Power transformer and motor winding measurement.
- High accuracy battery resistance testing.
- Ground grid integrity testing by measuring the resistance between two risers.
- U contact measurement.

### SUPPORTED INSTRUMENTS

- MI 3152 EurotestXC (Bluetooth, RS-232)
- MI 3152H EurotestXC 2.5kV (Bluetooth, RS-232)
- MI 3155 EurotestXD (Bluetooth, RS-232)
- MI 3325 MultiserviserXD (Bluetooth only)
- aMESM as a console for performing tests

### STANDARDS

#### Electromagnetic compatibility:

- EN 61326

#### Safety:

- EN 61010-1
- EN 61010-2-030
- EN 61010-031
- EN 61010-2-032

#### Functionality:

- EN 61557
- IEEE 81-2012
- EN 60947-2 Annex M
- EN 60909-0

#### Li-ion battery pack:

- EN 62133-2

## TECHNICAL DATA

FUNCTION	Measuring range	Resolution	Accuracy
Impedance [Z] Z line mΩ Z loop mΩ	0.1 mΩ ... 199.9 mΩ 200 mΩ ... 1999 mΩ 2.00 Ω ... 19.99 Ω	0.1 mΩ 1 mΩ 10 mΩ	±(5 % of reading + 3 mΩ)  ±(5 % of reading + 3digits)
Impedance [Z] High Current ΔR	0.1 mΩ ... 199.9 mΩ 200 mΩ ... 1999 mΩ 2.00 Ω ... 19.99 Ω	0.1 mΩ 1 mΩ 10 mΩ	±(5 % of reading + 3 mΩ)  ±(5 % of reading + 3digits)
Impedance [Z] High Current Rsel	0.1 mΩ ... 199.9 mΩ 200 mΩ ... 1999 mΩ 2.00 Ω ... 19.99 Ω	0.1 mΩ 1 mΩ 10 mΩ	±(8 % of reading + 3 mΩ)  ±(8 % of reading + 3digits)
DC Resistance [R] R line mΩ	0 mΩ ... 1999 mΩ 2.00 Ω ... 19.99 Ω	1 mΩ 10 mΩ	±(5 % of reading + 3digits)
Earth Potential [U] Utouch	0.0 V ... 199.9 V 200 V ... 999 V	0.1 V 1 V	Calculated value
Earth Potential [U] Um	1 mV ... 1999 mV 2.00 V ... 19.99 V 20.0 V ... 199.9 V	1 mV 10 mV 0.1 V	±(2 % of reading + 2 digits)
ELR Test [I and t] ELR I	0.1 mA ... 199.9 mA 200 mA ... 1999 mA 2.00 A ... 19.99 A	0.1 mA 1 mA 10 mA	±(5 % of reading + 3 digits)
ELR Test [I and t] ELR t	0.1 ms ... 199.9 ms 200 ms ... 1999 ms 2.00 s ... 20.00 s	0.1 ms 1 ms 10 ms	±(2 % of reading + 3 digits)

FUNCTION	Type	Range	Measuring range	Display range	Resolution	Uncertainty
Current [I] I	A 1281	0.5 A	10 mA ... 749 mA	0 ... 749 mA	1 mA	±(2.5 % of reading + 3 digits)
		5 A	0.10 A ... 7.49 A	0.00 ... 7.49 A	0.01 A	
		100 A	2 A ... 149 A	0.0 ... 99.9 A	0.1 A	
		1000 A	20 A ... 999 A	0 ... 999 A	1 A	
Current [I] I	A 1227 A 1609	30 A	0.6 A ... 59.9 A	0.0 ... 59.9 A	0.1 A	±(3.5 % of reading + 3 digits)
		300 A	6 A ... 599 A	0 ... 599 A	1 A	
		3000 A	0.06 kA ... 5.99 kA	0.00 ... 5.99 kA	0.01 kA	

### GENERAL DATA

Battery power supply	7,2 V DC (4,4 Ah Li-ion)
Battery charging time	typical 3,0 h (deep discharge)
Mains power supply	90 ... 260 VAC, 45 ...65 Hz, 80 VA
Over-voltage category	300 V CAT II
Protection classification	reinforced insulation
Measuring category	600 V CAT IV
Pollution degree	2
Degree of protection	IP 65 (case closed), IP 54 (case open)
Dimensions	360 x 160 x 330 mm
Weight	7 kg, (without accessories)

### STANDARD SET

#### MI 3144 ST

- Instrument MI 3144 Euro Z 800 V
- Mains cable
- RS232-PS/2 cable
- Test lead 5 m, black, 2 pcs
- Test lead 5 m, red, 2.5 mm<sup>2</sup>, 2 pcs
- Test lead 50 m, red, 2.5 mm<sup>2</sup>\*
- Test lead 20 m, black
- Test lead 50 m, green\*
- Large Kelvin test clip, 2 pcs
- Crocodile clip, black, 2 pcs
- Crocodile clip, red, 2 pcs
- Crocodile clip, green
- Test probe, black, 2 pcs
- Test probe, red, 2 pcs
- G clamp
- Human body resistance probe

- Test rod, 2 pcs
- Step voltage plates, 2 pcs
- Metrel aMESM Android PRO P 1102-AND Licence key integrated in instrument
- Short instruction manual
- Calibration certificate
- Protective bag for accessories (mounted on the case)
- Soft carrying bag\*

\* Replaced by test leads on a cable reel in MI 3144 EU set.

#### MI 3144 EU

- MI 3144 ST
- Test lead 5m, green
- Test lead on a cable reel, 75 m, red, 2.5 mm<sup>2</sup>
- Test lead on a cable reel, 75 m, green
- Professional current earth spike, 42 cm
- 1-phase flexible current clamp 3000/300/30 A / 1V (A 1609) with 5m current clamp extension cable (A 1648)

- Jumbo case
- Extension cable reel
- Jumbo case mount



Picture of MI 3144 EU set

# Other instruments / adapters / accessories

## MI 3143 Euro Z 440 V



The MI 3143 Euro Z 440 V is a Multi-function, portable battery (Li-ion) or mains powered test instrument with excellent IP protection: IP65 (case closed), IP54 (case opened). It can be controlled via an Android app aMESM, MI 3152, MI 3152H, MI 3155 or MI 3325. The MI 3143 Euro Z 440 V is intended for measuring the effectiveness of automatic trip out protection in case of faults in transformers and other HV equipment. With its high precision line and loop impedances on AC circuits, high current dR 300A loop and line measurements for testing partial voltage drops and contact voltage measurement, it is ideal for testing in industrial settings.

### KEY FEATURES

- **Hi Precision 4-wire 220A Z Line and Z Loop Impedance Tester;**
- **Hi Range impedance measurements in 440 V / 16 ... 420 Hz AC Networks;**
- **Hi Current dR 300A 4-wire Partial Voltage drops;**
- **Ground Fault Analysis** with Contact, Touch and Step Voltage;
- Floating Voltmeter for partial contact results
- **Selectable test load** (33.3 % to 100 %);
- Improved thermal performance;
- Portable battery (Li-ion) or mains powered test instrument;
- IP protection: IP65 (case closed), IP54 (case opened);
- **CAT IV 600V (3000 m) safety category;**
- Bluetooth communication;
- Remote controlled with supported Metrel safety testers or aMESM.

### APPLICATION

- Live Power Transformer Hi Precision 4-wire 220A Z Line / Loop Impedance Testing.
- Partial Voltage Drops Resistances.
- Earth Potentials by method of measuring Step, Touch and Transfer voltages.
- Automatic trip-out protection evaluation in case of faults in transformers, generators, turbines, contactors, distribution boards and switchyards whenever energetic loads and sources of protection exceed 200A.
- Power transformer and motor winding measurement.
- Ground grid integrity testing by measuring the resistance between two risers.
- U contact measurement.
- High current injection ground fault simulation.

### SUPPORTED INSTRUMENTS

- MI 3152 EurotestXC (Bluetooth, RS-232)
- MI 3152H EurotestXC 2.5kV (Bluetooth, RS-232)
- MI 3155 EurotestXD (Bluetooth, RS-232)
- MI 3325 MultiserviserXD (Bluetooth only)
- aMESM as a console for performing tests

### STANDARDS

#### Electromagnetic compatibility:

- EN 61326

#### Safety:

- EN 61010-1
- EN 61010-2-030
- EN 61010-031

#### Functionality:

- EN 61557
- IEEE 81-2012
- EN 60909-0

#### Li-ion battery pack:

- EN 62133-2

## TECHNICAL DATA

FUNCTION	Measuring range	Resolution	Accuracy
Impedance [Z]	0.1 mΩ ... 199.9 mΩ	0.1 mΩ	±(5 % of reading + 3 mΩ)
Z line mΩ	200 mΩ ... 1999 mΩ	1 mΩ	
Z loop mΩ	2.00 Ω ... 19.99 Ω	10 mΩ	±(5 % of reading + 3digits)
Impedance [Z]	0.1 mΩ ... 199.9 mΩ	0.1 mΩ	±(5 % of reading + 3 mΩ)
High Current ΔR	200 mΩ ... 1999 mΩ	1 mΩ	
	2.00 Ω ... 19.99 Ω	10 mΩ	±(5 % of reading + 3digits)
DC Resistance [R]	0 mΩ ... 1999 mΩ	1 mΩ	±(5 % of reading + 3digits)
R line mΩ	2,00 Ω ... 19,99 Ω	10 mΩ	
Earth Potential [U]	0.0 V ... 199.9 V	0.1 V	Calculated value
Utouch	200 V ... 999 V	1 V	
Earth Potential [U]	1 mV ... 1999 mV	1 mV	±(2 % of reading + 2 digits)
Um	2.00 V ... 19.99 V	10 mV	
	20.0 V ... 199.9 V	0.1 V	

### GENERAL DATA

Battery power supply	7.2 V DC (4,4 Ah Li-ion)
Battery charging time	typical 3,0 h (deep discharge)
Mains power supply	90 ... 260 VAC, 45 ...65 Hz, 80 VA
Over-voltage category	300 V CAT II
Protection classification	reinforced insulation
Measuring category	600 V CAT IV
Pollution degree	2
Degree of protection	IP 65 (case closed), IP 54 (case open)
Dimensions	360 x 160 x 330 mm
Weight	6.5 kg, (without accessories)

### STANDARD SET

#### MI 3143 ST

- Instrument MI 3143 Euro Z 440 V
- Mains cable
- RS232-PS/2 cable
- Test lead, 2-wire, 2 pcs\*
- Crocodile clip, black, 2 pcs
- Crocodile clip, red, 2 pcs
- Test probe, black, 2 pcs
- Test probe, red, 2 pcs
- Metrel aMESM Android PRO P 1102-AND Licence key integrated in instrument
- Short instruction manual
- Calibration certificate
- Protective bag for accessories (mounted on the case)

\* Replaced by 5 m and 20 m test leads in MI 3143 EU set.

#### MI 3143 EU

- MI 3143 ST
- Test lead 5 m, black, 2 pcs
- Test lead 5 m, red, 2.5mm<sup>2</sup>, 2 pcs
- Test lead 20 m, red, 2.5mm<sup>2</sup>
- Test lead 20 m, black
- Test lead 20 m, green
- Large Kelvin test clip, 2 pcs
- G clamp
- Human body resistance probe
- Test rod, 2 pcs
- Step voltage plates, 2 pcs
- Soft carrying bag



Picture of MI 3143 EU set

# Other instruments / adapters / accessories

## A 1722 PRCD adapter



The A 1722 PRCD Adapter is a multi-function test adapter intended for safety and functional testing of different types of 1-phase and 3-phase PRCDs. The adapter supports simulation of different error states and it has connection inputs for testing of PE wire (if monitored by PRCD), probe test (to test PRCD's touch electrode) and other applicable tests for standardized PRCD's testing. If used together with the MI 3155 Eurotest XD AUTO SEQUENCE®, the complete PRCD can be tested (state-by-state) electrically and functionally with a push of a button. It is possible to create a professional PRCD-based report with MESM.

### KEY FEATURES

- Simulation of errors on input mains;
- Accessible Inputs/Outputs for easy connection of safety testers;
- Enables testing Continuity in PRCDs with the PE wire monitored.

### SUPPORTED INSTRUMENTS

- MI 3155 EurotestXD;
- MI 3152 EurotestXC;
- MI 3152H EurotestXC 2.5kV

### STANDARDS

#### Safety:

- EN 61010-1

#### Functionality:

- DIN VDE 0701-0702;
- DIN VDE 0661;
- DIN VDE 0100-410

### APPLICATION

#### • Functional testing of the following types of PRCD's:

- PRCD-S (1-phase / 3 pole & 3-phase / 5pole);
- PRCD-S+ (1-phase / 3 pole);
- PRCD-K/Di (1-phase);
- PRCD (2pole and 3pole).

#### • Functional testing, simulation of following faults:

- L-open (for 3-phase L1-L3);
- N-open;
- PE-open;
- Reversed wires (for 1-phase L <> PE / L <> N, for 3-phase L1,L2,L3 <> PE / L1,L2,L3 <> N);
- External voltage on PE.

- Measurement of protective conductor;
- Measurement of insulation resistance;
- Measurement of PE-current with optional current clamps;
- Tripping test;
- Probe test.

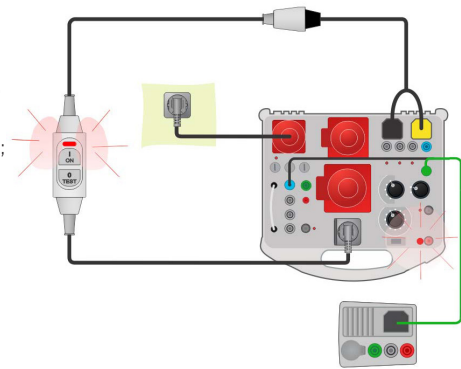

Testing the continuity of the protective earth conductor.

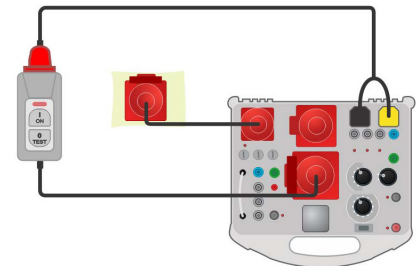

Testing the 3-phase PRCD



## TECHNICAL DATA

Error functions	State	Description
Input fault 1-phase	L op	L/L1 conductor open
	N op	N conductor open
	PE op	PE conductor open
	L<>PE	L and PE conductors reversed
	L<>N	L and N conductors reversed
	Uext (PE)	External voltage on PE
Input fault 3-phase	L1 op	L1 conductor open
	L2 op	L2 conductor open
	L3 op	L3 conductor open
	N op	N conductor open
	PE op	PE conductor open
	L1<>PE	L1 and PE conductors reversed
	L2<>PE	L2 and PE conductors reversed
	L3<>PE	L3 and PE conductors reversed
	L1<>N	L1 and N conductors reversed
	L2<>N	L2 and N conductors reversed
	L3<>N	L3 and N conductors reversed
Uext (PE)	External voltage on PE	
General	Mains power supply	90-260 VAC, 45-65 Hz
	Protection category	300 V CAT II
	Measuring category	300 V CAT II
	Degree of protection	IP 65 (case closed) IP 40 (case open) IP 20 (mains test socket)
	Dimensions	360 x 160 x 330 mm
	Weight	4.8 kg
	Working temperature range	-10 °C ... 50 °C
	Maximum relative humidity	90 %RH (0 °C ... 40 °C), non-condensing
	Working nominal altitude	up to 3000 m

## AUTO SEQUENCE EXAMPLE

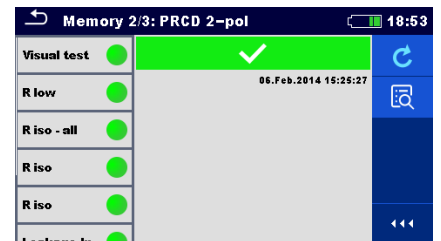
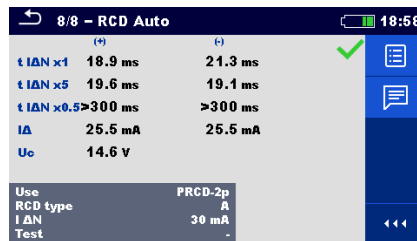
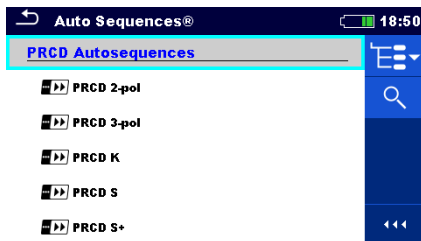

### STANDARD SET

#### Standard set A 1722

- PRCD Adapter A 1722
- 1-ph EU - 3 ph CEE (16 A) mains cable, length 2 m
- 1-ph Y - shuko cable A 1723, length 2 m

- 2 mm banana to 4 mm cascade banana adapter, cable length 1 m
- Test probe, red
- Protective bag for accessories (mounted on the case)
- Instruction manual



Picture of A 1722 set

# Other instruments / adapters / accessories

## MI 3132 EV Tester



MI 3132 EV tester is a portable, battery powered test instrument with excellent IP protection and designed especially for electric vehicle testing. The instrument support the latest standard UN ECE R100 Annex 4A, 4B, intended for measurement of insulation resistance for electric vehicle. The instrument is ergonomic in design with intuitive user interface, encompassing a memory organizer and fully programmable AUTO SEQUENCES, managed through a large colour touch screen display. Besides those, the instrument supports a wide range of tests and measuring functions, including 2 A Micro Ohm measurement, on-line voltage monitoring, insulation test up to 1500 V, as well as functional and visual inspections.

### MEASURING FUNCTIONS

- Insulation measurements according to **UN ECE R100** and **ISO 6469-3** with own REESS as DC voltage source;
- **Insulation resistance** with DC voltage from 50 V to **1500 V**;
- DC voltage measurement;
- TRMS voltage and frequency measurements;
- **Four wire Micro Ohm** measurements with **2 A DC** test current;
- Low Ohm measurements with 7 mA and 200 mA DC test current;
- Visual safety and functional inspections.

### KEY FEATURES

- Insulation resistance measuring according to UN ECE **R100** measuring using internal DC source;
- Performing accurate four wire measurements with **Kelvin clamps and up to 2 A** measuring current;
- Settable duration and current direction (unidirectional or bidirectional) in the Micro Ohm measurement;;
- Insulation range: wide range of insulation test voltages from 50 V to **1500 V**,

- resistance measuring range up to 3 G $\Omega$ ;
- Overvoltage category 1000 V CAT III;
- 4.3" colour LCD display with touch screen;
- **Programmable AUTO SEQUENCES**;
- High degree of protection for outdoor use and rough environment;
- DC resistance measurements;
- Support for single or automated measurements;
- Built-in charger and rechargeable **Li-Ion batteries** as standard accessory;
- **BT communication** with PC, via built-in BT module;
- **PC SW Metrel ES Manager** for measurement pre and post processing: preparation of the test structure, result download, tree-view, table view and graphical view, storing and printing.

### APPLICATION

- Electric vehicle high voltage cables insulation and resistance test;
- Battery insulation check;
- EV chassis and components bonding test;
- EV safety tests;
- Mode 3 charging cables insulation and resistance test
- Electric vehicle after crash safety check;

- Electrical troubleshooting;
- For electric vehicle services, workshops and production facilities;
- Test at Periodic Technical Inspections

### STANDARDS

#### Functionality

- UN ECE R100
- ISO 6469-3

#### Electromagnetic compatibility

- EN 61326

#### Safety

- EN 61010 - 1
- EN 61010 - 2 - 030
- EN 61010 - 031
- EN 61557

## TECHNICAL DATA

Function		Measuring range	Resolution	Accuracy	
<b><math>\mu\Omega</math> - Meter</b>	1 A, 2 A	0.000 m $\Omega$ ... 1.999 m $\Omega$	1 $\mu\Omega$	$\pm(1\%$ of reading + 5 digit)	
		2.00 m $\Omega$ ... 19.99 m $\Omega$	10 $\mu\Omega$	$\pm(0.5\%$ of reading + 2 digit)	
		20.0 m $\Omega$ ... 199.9 m $\Omega$	100 $\mu\Omega$	$\pm(0.5\%$ of reading + 1 digit)	
		200 m $\Omega$ ... 499 m $\Omega$	1 m $\Omega$	$\pm(0.5\%$ of reading)	
	1 A	0.500 $\Omega$ ... 1.999 $\Omega$	1 m $\Omega$	$\pm(0.5\%$ of reading)	
	100, 200 mA	0.00 m $\Omega$ ... 19.99 m $\Omega$	10 $\mu\Omega$	$\pm(0.5\%$ of reading + 5 digit)	
		20.0 m $\Omega$ ... 199.9 m $\Omega$	100 $\mu\Omega$	$\pm(0.5\%$ of reading + 2 digit)	
		200 m $\Omega$ ... 1999 m $\Omega$	1 m $\Omega$	$\pm(0.5\%$ of reading + 1 digit)	
		2.00 $\Omega$ ... 19.99 $\Omega$	0.01 $\Omega$	$\pm(0.5\%$ of reading + 1 digit)	
		20.0 $\Omega$ ... 199.9 $\Omega$	0.1 $\Omega$	$\pm(1\%$ of reading + 1 digit)	
		200 $\Omega$ ... 1999 $\Omega$	1 $\Omega$	$\pm(2\%$ of reading)	
	10 mA	0.0 m $\Omega$ ... 199.9 m $\Omega$	100 $\mu\Omega$	$\pm(2\%$ of reading + 5 digit)	
		200 m $\Omega$ ... 1999 m $\Omega$	1 m $\Omega$	$\pm(2\%$ of reading)	
		2.00 $\Omega$ ... 19.99 $\Omega$	0.01 $\Omega$	$\pm(2\%$ of reading)	
		20.0 m $\Omega$ ... 199.9 $\Omega$	0.1 $\Omega$	$\pm(2\%$ of reading)	
200 $\Omega$ ... 1999 $\Omega$		1 $\Omega$	$\pm(2\%$ of reading)		
<b><math>\Omega</math> - Meter</b>	1 A, 2 A	0.000 $\Omega$ ... 0.499 $\Omega$	1 m $\Omega$	$\pm(0.5\%$ of reading + 10 digit)	
	1 A	0.500 $\Omega$ ... 1.999 $\Omega$	1 m $\Omega$	$\pm(1\%$ of reading)	
	100, 200 mA	0.000 $\Omega$ ... 1.999 $\Omega$	1 m $\Omega$	$\pm(1\%$ of reading + 10 digit)	
		2.00 $\Omega$ ... 19.99 $\Omega$	10 m $\Omega$	$\pm(1\%$ of reading)	
		20.0 $\Omega$ ... 199.9 $\Omega$	100 m $\Omega$	$\pm(1\%$ of reading)	
		200 $\Omega$ ... 1999 $\Omega$	1 $\Omega$	$\pm(2\%$ of reading)	
	10 mA	0.00 $\Omega$ ... 19.99 $\Omega$	10 m $\Omega$	$\pm(1\%$ of reading + 10 digit)	
		20.0 $\Omega$ ... 199.9 $\Omega$	100 m $\Omega$	$\pm(1\%$ of reading)	
		200 $\Omega$ ... 1999 $\Omega$	1 $\Omega$	$\pm(2\%$ of reading)	
	<b>Continuity</b>		0.0 $\Omega$ ... 199.9 $\Omega$	0.1 $\Omega$	$\pm(3\%$ of reading + 2 digit)
			200 $\Omega$ ... 1999 $\Omega$	1 $\Omega$	$\pm(3\%$ of reading)
		2.00 k $\Omega$ ... 19.99 k $\Omega$	10 $\Omega$	$\pm(5\%$ of reading)	
		20.0 k $\Omega$ ... 199.9 k $\Omega$	100 $\Omega$	$\pm(10\%$ of reading)	
<b>Riso</b>	Uiso < 250 V	0.000 M $\Omega$ ... 1.999 M $\Omega$	1 k $\Omega$	$\pm(3\%$ of reading + 3 digit)	
		2.00 M $\Omega$ ... 19.99 M $\Omega$	10 k $\Omega$	$\pm(3\%$ of reading)	
		20.0 M $\Omega$ ... 199.9 M $\Omega$	100 k $\Omega$	$\pm(5\%$ of reading)	
	Uiso $\geq$ 250 V	0.000 M $\Omega$ ... 1.999 M $\Omega$	1 k $\Omega$	$\pm(3\%$ of reading + 5 digit)	
		2.00 M $\Omega$ ... 19.99 M $\Omega$	10 k $\Omega$	$\pm(3\%$ of reading)	
		20.0 M $\Omega$ ... 199.9 M $\Omega$	100 k $\Omega$	$\pm(3\%$ of reading)	
		200 M $\Omega$ ... 999 M $\Omega$	1 M $\Omega$	$\pm(5\%$ of reading)	
		1.00 G $\Omega$ ... 2.99 G $\Omega$	10 M $\Omega$	$\pm(10\%$ of reading)	
	<b>Voltage</b>	Uac	0.000 V ... 9.999 V	0.001 V	Freq. range: 15 Hz ... 99 Hz, $\pm(0.5\%$ of reading + 3 digits)
			10.00 V ... 99.99 V	0.01 V	Freq. range: 100 Hz ... 399 Hz, $\pm(1\%$ of reading + 3 digits)
100.0 V ... 749.9 V			0.1 V	Freq. range: 400 Hz ... 1200 Hz, $\pm(10\%$ of reading + 3 digits)	
Udc		0.000 V ... 9.999 V	0.001 V		
		10.00 V ... 99.99 V	0.01 V	$\pm(0.5\%$ of reading + 3 digits)	
		100.0 V ... 999.9 V	0.1 V		
U		0.000 V ... 9.999 V	0.001 V	Freq. range: DC, 15 Hz ... 99 Hz, $\pm(0.5\%$ of reading + 3 digits)	
		10.00 V ... 99.99 V	0.01 V	Freq. range: 100 Hz ... 399 Hz, $\pm(1\%$ of reading + 3 digits)	
		100.0 V ... 999.9 V	0.1 V	Freq. range: 400 Hz ... 1200 Hz, $\pm(10\%$ of reading + 3 digits)	
<b>f</b>			15.00 Hz ... 99.99 Hz	0.01 Hz	
			100.0 Hz ... 999.9 Hz	0.1 Hz	$\pm(0.2\%$ of reading + 1 digits)
			1.000 kHz ... 1.200 kHz	1 Hz	
<b>RISO EV R100</b>	Riso (lower result)	0 ... 999 $\Omega/V$	1 $\Omega/V$	$\pm(3\%$ of reading + 2 digits)	
		1.00 ... 4.99 k $\Omega/V$	10 $\Omega/V$	$\pm(5\%$ of reading)	
		5.0 ... 19.9 k $\Omega/V$	100 $\Omega/V$	$\pm(10\%$ of reading)	
	Riso (higher result)	20.0 ... 49.9 k $\Omega/V$	100 $\Omega/V$	$\pm(20\%$ of reading)	
		0 ... 999 $\Omega/V$	1 $\Omega/V$		
		1.00 ... 4.99 k $\Omega/V$	10 $\Omega/V$	Indicative	
		5.0 ... 19.9 k $\Omega/V$	100 $\Omega/V$		
		20.0 ... 49.9 k $\Omega/V$			

### STANDARD SET

#### Standard set MI 3132 ST

- Instrument MI 3132 EV Tester
- A 1551 Carrying bag (L)
- A 1707 Set of carrying straps
- A 1782 4-wire test lead, 2 x 2 m, 2 x 5 m
- A 1781 3-wire test lead, 3 x 1.5 m
- A 1780 2-wire test lead, 2 x 1.5 m
- A 1014 Test probe, black
- A 1016 Test probe, red
- A 1298 Test probe, brown

- A 1453 Test probe, grey
- A 1013 Crocodile clip, black, 2 pcs
- A 1064 Crocodile clip, red, 2 pcs
- A 1309 Crocodile clip, green
- A 1727 USB cable
- A 1567 4400mAh battery pack
- A 1569 Power supply adapter 12 V, 3 A
- Instruction manual (short version)
- Calibration Certificate
- SW 1201 PC SW Metrel ES Manager



Picture of MI 3132 set

# Other instruments / adapters / accessories

## A 1632 eMobility Analyser



The A 1632 eMobility Analyser is a special accessory designed for functional, diagnostic and electrical safety testing of Electric Vehicle Supply Equipment (EVSE) together with Type 2 connections through the support of METREL installation testers. It also supports testing of Mode 2 electrical vehicle (EV) cable safety features through mains fault simulation and electrical safety testing of both Mode 2 and Mode 3 EV charging cables. Fully supported professional station-based and cable-based report creation with MESM software.



### KEY FEATURES

- Functional testing of EVSE via simulation of electrical vehicle's CP and PP circuits
- Diagnostic testing of EVSE via simulation of errors on CP circuit.
- Electrical safety testing of EVSE.
- Functional testing of Mode 2 EV cables via simulation of electrical vehicle's CP and PP circuits.
- Diagnostic testing of Mode 2 EV cables via simulation of errors on CP circuit.
- Simulation of faults on mains for verification of Mode 2 EV charging cable safety features.
- Electrical safety testing of Mode 2 and Mode 3 EV cables.
- Accessible inputs/outputs for connection of safety testers.
- 1-phase and 3-phase Mode 2 cable connections.
- Integrated 4400 mAh Li-Ion battery.
- Bluetooth communication with Metrel safety testers.

### SUPPORTED INSTRUMENTS

- MI 3152 EurotestXC
- MI 3152H EurotestXC 2.5kV
- MI 3155 EurotestXD
- MI 3325 MultiserviserXD
- Android App eMobility as a console for performing functional EVSE tests.

### STANDARDS

#### Electromagnetic compatibility:

- EN 61326

#### Safety:

- EN 61010-1
- EN 61010-2-030
- EN 61010-031

#### Functionality:

- EN 61851-1
- HD 60364-6
- EN 60364-7-722
- EN 61557 series

#### Li - ion battery pack:

- IEC 62133

### COMPLETE EVSE TESTING

The combination of A 1632 or A 1532 with Metrel's installation testers, the MI 3155 or MI 3152, offers a complete solution for testing in circuits with a **EV RCD** or **EV RCM 6 mA d.c. trip-out protection**. It is possible to perform a **complete RCD test sequence including the 6 mA d.c. ramp test and loop impedance (Zs rcd) measurement without tripping 6 mA d.c. EV RCD or EV RCM**. This makes Metrel compliant with standards **IEC 62752** (when Mode 2 EV cables are used) and **EN 62955** (when Mode 3 cables are used).

### APPLICATION

- EVSE functional and diagnostic testing according to EN 61851-1 and electrical safety testing according to EN 60364-6.

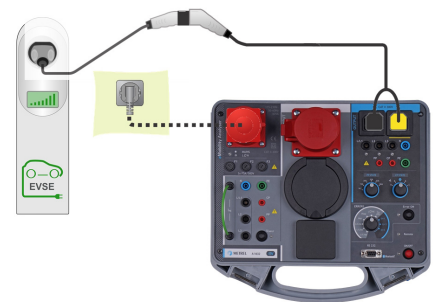

- Simulation of faults on mains for verification of Mode 2 electrical vehicle (EV) charging cable safety features.

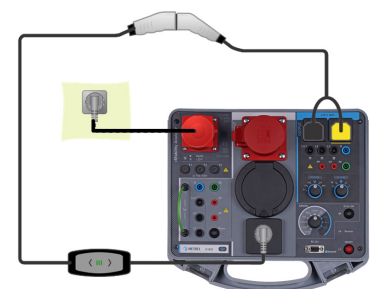

## TECHNICAL DATA

FUNCTION		Measuring range	Resolution	Accuracy
Nominal system voltage range		100 VAC ... 440 VAC	1 V	±2 % of reading + 2 dig)
Nominal frequency range		0 Hz, 14 Hz ... 500 Hz		
Phase rotation		1.2.3 or 3.2.1		
Voltage UCP+, UCP-		-19.99 V ... 19.99 V	1 V	±(2 % of reading + 2 dig)
Frequency		500 ... 1500 Hz	0.1 Hz	±1 % of reading
Duty cycle		0.1 ... 99.9 %	0.1 %	±10 dig
Ievse		0.0 ... 99.9 A	0.1 A	Calculated value
Toff		0 ... 399 ms	1 ms	±(1 % of reading + 5 dig)
Simulation functions	State	Misc.		
PP simulation	n.c	> 300 kΩ		
	13 A	1.5 kΩ ± 1.5 %		
	20 A	680 Ω ± 1.5 %		
	32 A	220 Ω ± 1.5 %		
	63 A	100 Ω ± 1.5 %		
	80 A	56 Ω ± 1.5 %		
CP simulation	A	> 300 kΩ		
	B	2.74 kΩ ± 1.5 %		
	C	882 Ω ± 1.5 %		
	D	246 Ω ± 1.5 %		
Diag. functions	error	Misc.		
System state	A1	no EV connected		
	A2	no EV connected / PWM		
	B1	EV connected		
	B2	EV connected / PWM		
	C1	EV charged		
	C2	EV charged / PWM		
	D1	EV charged and ventilation on		
	D2	EV charged and ventilation on / PWM		
	E	Error		
	F	Failure		
Error functions	Invalid	CP signal can't be classified		
	State	Misc.		
Uinput fault	L/L1op	L/L1 conductor open		
	L/L2op	L/L2 conductor open		
	L/L3op	L/L3 conductor open		
	Nop	N conductor open		
	PEop	PE conductor open		
	L<>PE	L/L1and PE conductors crossed		
	Uext (PE)	External voltage on PE (on input side)		

- Electrical safety testing of 1-phase and 3-phase Mode 2 EV cables
- Electrical safety testing of Mode 3 EV cables.

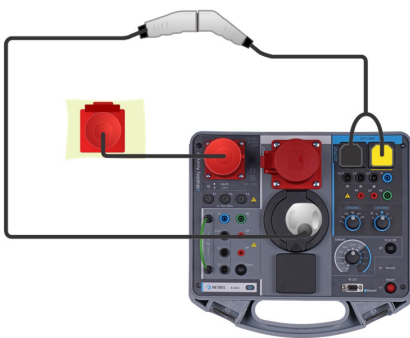

Diagnostic Test (EVSE)		14:33	
CP+	5.9 V	U1N	229 V
CP-	-11.6 V	U2N	13 V
D	21.3 %	U3N	12 V
Freq	999.9 Hz		
Ievse	12.8 A		
State <b>C2</b>			
Test	EV simulator		
Simulator_CP	C		
Simulator_PP	32 A		
Duration	Off		
Control	Instrument		

### General

Battery power supply	7.2 V DC (4.4 Ah Li-ion)
Battery charging time	typical 4 h (deep discharge)
Mains power supply	115 V/230 V ± 10 %, 230 V/400 V 3~ ± 10 % - 50 Hz - 60 Hz, 60 VA
Protection category	300 V CAT II
Measuring category	300 V CAT II
Degree of protection	IP 65 (case closed), IP 40 (case open), IP 20 (mains test socket)
Dimensions (W x H x D)	36 cm x 16 cm x 33 cm
Working temperature range	-10 °C ... 50 °C
Maximum relative humidity	90 %RH (0 °C ... 40 °C), non-condensing
Working nominal altitude	up to 3000 m
Bluetooth module	Class 2

### STANDARD SET

- A 1632**
- A 1632 eMobility Analyser
  - Type 2 Male plug adapter with long CP pin (2 x Metrel connector), 2 m
  - 1-phase EU - 3 phase CEE (16 A) mains cable, 2 m
  - 2 mm banana to 4 mm cascade banana adapter, 1 m
  - Protective bag for accessories \*
  - Instruction manual
  - Calibration certificate

\* Mounted on the case



Picture of A 1632 set

# Other instruments / adapters / accessories

## A 1631 EV monitoring cable



The A 1631 EV monitoring cable is a special accessory designed for CP signal, current and voltage monitoring during Electric Vehicle (EV) charging process in conjunction with supported Metrel testers and adapters. It is equipped with a Type 2 female plug connector to connect to an EV and a Type 2 male socket outlet for connecting to Electrical Vehicle Supply Equipment (EVSE).

### KEY FEATURES

- Monitoring during a.c. EV charging with up to 32 A EVSE:
  - CP signal communication monitoring during charging;\*
  - PP resistance;
  - Current;
  - Voltage;
- Possible to connect instruments for current and voltage verification (i.e. MI 2883 Energy Master, MI 2884 Energy Master XA);
- Possible to simulate external load (up to 13 A) via banana plugs and verify EVSE counters.

### SUPPORTED INSTRUMENTS

- MI 3152 EurotestXC;
- MI 3155 EurotestXD

### STANDARDS

#### Functionality:\*

- EN 61851-1;
- HD 60364-6;
- EN 60364-7-722

#### Electromagnetic compatibility:

- EN 61326

### APPLICATION

- Monitoring of the EV charging process.

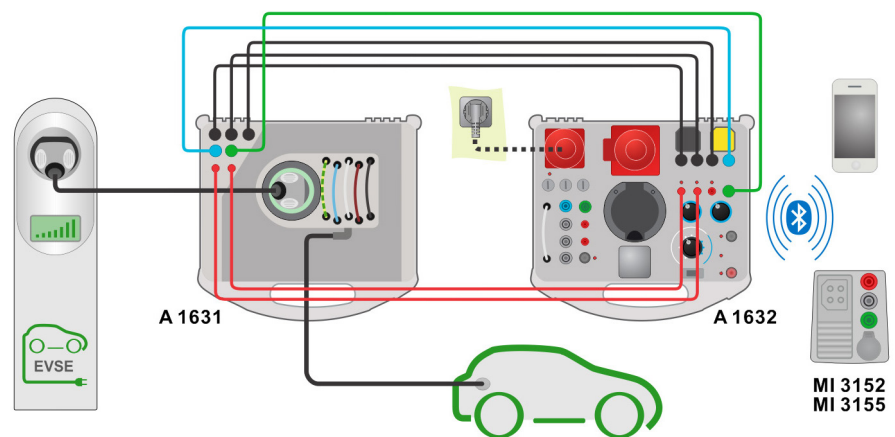

#### Safety:

- EN 61010-1;
- EN 61010-2-030;
- EN 61010-031

\* Requires: A 1632 eMobility Analyser and MI 3152 EurotestXC or MI 3155 EurotestXD.

## TECHNICAL DATA

Measurement functions	Value
Max. charging current of a.c. EVSE with Type2 connectors	32 A
Max. external load during EV simulation via banana plugs	13 A
<b>General</b>	
Mains power supply	230 V / 400 V 3~ ± 10 % 50 Hz - 60 Hz, 60 VA 32 A
Protection category	300 V CAT II
Measuring category	300 V CAT II
Degree of protection	IP 65 (case closed) IP 40 (case open)
Dimensions	360 x 160 x 330 mm
Working temperature range	-10 °C ... 50 °C
Maximum relative humidity	90 %RH (0 °C ... 40 °C), non-condensing
Working nominal altitude	up to 3000 m

### STANDARD SET

#### A 1631

- A 1631 EV monitoring cable 32 A
- Test lead, 1,5 m, 5 pcs (black - 3 pcs, green - 1 piece, blue - 1 piece)
- Test cable with 2 mm banana plug, red, 1 m, 2 pcs

\*The eMobility App can be downloaded free of charge from Android Market.



Picture of A 1631 set

# Other instruments / adapters / accessories

## A 1532 EVSE adapter



The A 1532 EVSE adapter is a special accessory intended for testing Electric Vehicle Supply Equipment (EVSE) together with supported METREL installation testers. It is used for verification of electrical safety and functional testing of EVSE. It is intended for testing Mode 3 EV supply equipment with a type 2 connector. If used together with the MI 3152 EurotestXC's AUTO SEQUENCE®, the complete EVSE charging station can be tested (state-by-state) electrically and functionally with a push of a button. It is possible to create a professional station-based report with MESM.

### KEY FEATURES

- Proximity Pilot (PP) resistance selector for simulation of EV cable presence and current rating detection;
  - Control Pilot (CP) resistance selector for simulation of electric vehicle status;
  - **CP error simulation;**
  - **CP communication monitoring** via external BNC connector;
  - Accessible inputs/outputs for connection of safety testers;
  - Socket output for connection to a 1-phase installation tester (Phase 1, Neutral, PE);
  - **Type 2** Male Plug connector for connection to EVSE;
  - Electrical safety testing of EVSE;
  - Voltage indicators on EVSE output;
  - 6 mA EV RCD support;\*
  - EVSE AUTO SEQUENCE® support;\*
  - MESM report creation;\*\*
- Basic support:**
- A 1532
- Partial support:**
- 6 mA EV RCD, EV RCM
  - EVSE report\*\*
- Full support\*:**
- Functional test support
  - EVSE AUTO SEQUENCE® support

\* Functional tests and AUTO SEQUENCE® are supported only on the MI 3152 EurotestXC and MI 3152 H EurotestXC 2.5 kV testers.  
\*\* Report printing is only available via the MESM PC SW. The MESM Licence (P 1101) is to be purchased separately.

### COMPLETE EVSE TESTING

The combination of A 1632 or A 1532 with Metrel's installation testers, the MI 3155 or MI 3152, offers a complete solution for testing in circuits with a **EV RCD** or **EV RCM 6 mA d.c. trip-out protection**. It is possible to perform a **complete RCD test sequence including the 6 mA d.c. ramp test and loop impedance (Zs rcd) measurement without tripping 6 mA d.c. EV RCD or EV RCM**. This makes Metrel compliant with standards **IEC 62752** (when Mode 2 EV cables are used) and **EN 62955** (when Mode 3 cables are used).

### APPLICATION

- On-site testing of EVSE charging station installation.
- Initial and periodic testing of private, semi-private and public EVSE charging stations.
- EVSE functional and diagnostic testing according to EN 61851-1 and electrical safety testing according to EN 60364-6.
- Possibility to test EVSE side of Mode 2 EV cables.
- Control Pilot (CP) fault simulation.

### STANDARDS

**Safety:**

- EN 61010-1

**Functionality:**

- EN 61851-1
- HD 60364-6
- EN 60364-7-722
- EN 61557 series



## TECHNICAL DATA

FUNCTION	Measuring range
Input voltage	400 V (3-phase)
Frequency	50 Hz - 60 Hz
Test current	267 A (10ms) intermittent operation
Proximity Pilot (PP) simulation	Open circuit, 13 A, 20 A, 32 A, 63 A
Control Pilot (CP) simulation	State A (not connected), State B (connected, not charging), State C (charging without ventilation) State D (charging with ventilation), State E (error - CP short to PE via 120 Ohm resistor)
Overvoltage category	300 V CAT II
Protection degree	IP 40
Pollution degree	2
Protection classification	Double insulation
Altitude	3000 m above sea level
Dimensions	250 x 100 x 70 mm
Test lead length	0.5 m
Weight	0.90 kg
Working temperature range	0 °C ... 40 °C @ 95 % RH, non-condensing
Storage temperature range	-10 °C ... +70 °C
Maximum storage relative humidity	90 % RH (-10 °C ... +40 °C) 80 % RH (40 °C ... 60 °C)

## SUPPORTED INSTRUMENTS

	A 1532 EVSE	EV RCD	EV RCM	Zs: no EV RCD trip	Functional inspections	EVSE Auto Sequences®	EVSE report
MI 3155 EurotestXD	•	•	•	•	•	•	•
MI 3152 EurotestXC	•	•	•	•	•	•	•
MI 3152H EurotestXC 2,5 kV	•	•	•	•	•	•	•
MI 3102 BT EurotestXE	•	•	•	•	•	•	•
MI 3102H BT EurotestXE 2,5 kV	•	•	•	•	•	•	•
MI 3125 BT Eurotest COMBO	•	•	•	•	•	•	•
MI 3100 SE EurotestEASI	•	•	•	•	•	•	•
MI 3100 s EurotestEASI	•	•	•	•	•	•	•
MI 3125 EurotestCOMBO	•	•	•	•	•	•	•

## STANDARD SET

### A 1532

- Instrument EVSE adapter
- Small soft carrying bag
- Instruction manual



Picture of A 1532 set

## AUTO SEQUENCE EXAMPLE

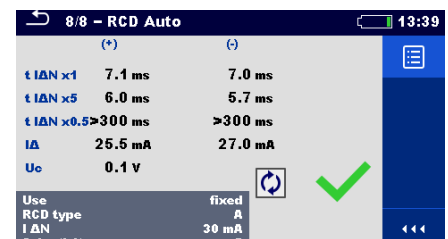
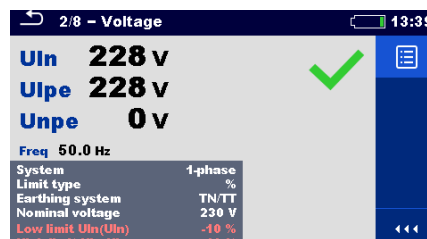
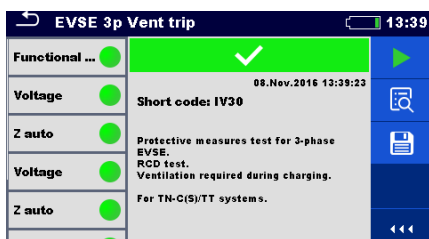
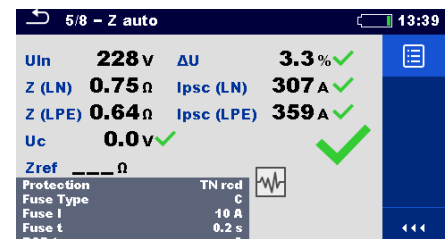
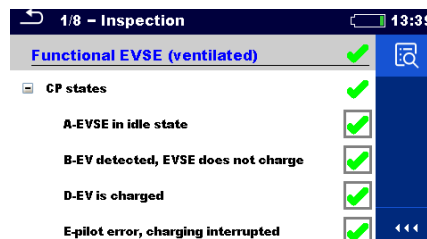
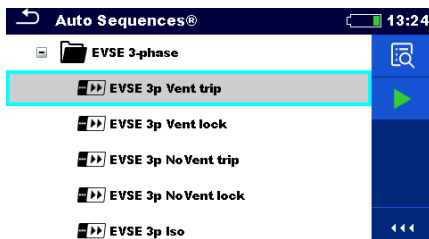

# Other instruments / adapters / accessories

## A 1532 XA EVSE adapter



The A 1532 EVSE XA adapter is used for verification of electrical safety and functional testing of EVSE together with supported METREL installation testers. It is intended for testing Mode 3 EV supply equipment with a type 2 connector. XA version supports 3 phase load testing up to 13 A and different error types, including PE open. If used together with Metrel AUTOSEQUENCES®, prebuilt in the newer multifunctional testers, the complete EVSE charging station can be tested (state-by-state) electrically and functionally with a push of a button. It is possible to create a professional station-based report with MESM.

### KEY FEATURES

- Banana socket outputs for connection to a 3-phase installation tester;
- Voltage indicators on EVSE output;
- Proximity Pilot resistance selector for simulation of EV cable presence and current rating detection;
- Control Pilot resistance selector for simulation of electric vehicle status;
- Socket output for connection to a 1-phase installation tester (Phase 1, Neutral, PE);
- Type 2 Male Plug connector for connection to EVSE;
- **6 mA EV RCD** support;
- **Functional tests** support;\*
- **EVSE AUTO SEQUENCE®** support;\*
- **MESM report** creation;\*\*
- **Load testing up to 13 A** on socket - 1 phase or on banana sockets - 3 phase;
- Fault simulation of **Diode short, PE-CP short and PE open**;
- Output BNC connector for CP signal monitoring.

### APPLICATION

- On-site testing of EVSE charging station installation;
- Initial and periodic testing of private, semi-private and public EVSE charging stations.

### STANDARDS

- Safety**
- EN 61010-1
- Functionality**
- EN 61851-1

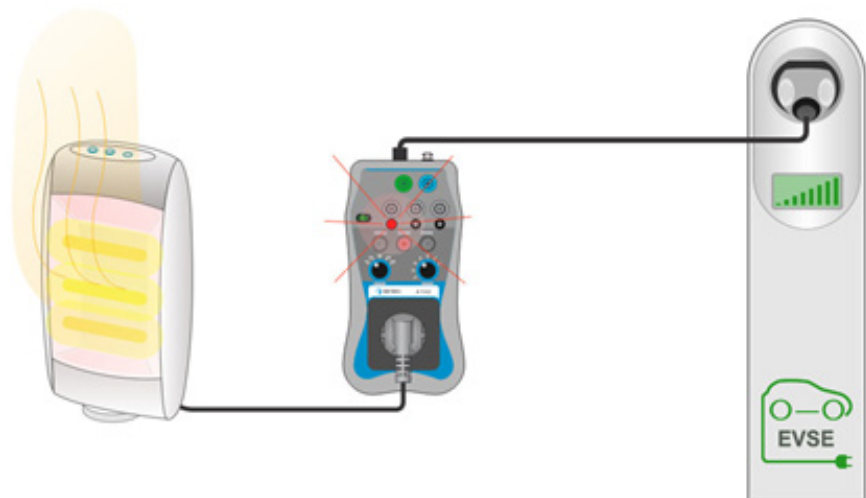

\* Functional tests and AUTO SEQUENCE® are supported only on the MI 3155 Eurotest XD, MI 3152 EurotestXC and MI 3152 H EurotestXC 2.5 kV testers.  
 \*\* Report printing is only available via the MESM PC SW. The MESM Licence (P 1101) is to be purchased separately.

## TECHNICAL DATA

FUNCTION	Measuring range
Input voltage	400 V (3-phase)
Frequency	50 Hz
Test current	267 A (10ms) intermittent operation
Maximum load current	13 A continuous operation
Proximity Pilot (PP) simulation	Open circuit 13 A 20 A 32 A 63 A
Control Pilot (CP) simulation	State A (not connected) State B (connected, not charging) State C (charging without ventilation) State D (charging with ventilation)
Error states	CP short to PE via 120 Ohm resistor Diode short PE open
Overtoltage category	300 V CAT II
Protection degree	IP 40
Pollution degree	2
Protection classification	Double insulation
Altitude	3000 m above sea level
Dimensions	250 x 100 x 70 mm
Test lead length	0.5 m
Weight	0.90 kg
Working temperature range	0 °C ... 40 °C @ 95 % RH, non-condensing
Storage temperature range	-10 °C ... +70 °C
Maximum storage relative humidity	90 % RH (-10 °C ... +40 °C) 80 % RH (40 °C ... 60 °C)

## SUPPORTED INSTRUMENTS

	A 1532 XA EVSE	EV RCD	EV RCM	Zs: no EV RCD trip	Functional inspections	EVSE Auto Sequences®	EVSE report
MI 3155 EurotestXD	•	•	•	•	•	•	•
MI 3152 EurotestXC	•	•	•	•	•	•	•
MI 3152H EurotestXC 2,5 kV	•	•	•	•	•	•	•
MI 3102 BT EurotestXE	•	•		•			•
MI 3102H BT EurotestXE 2,5 kV	•			•			•
MI 3125 BT Eurotest COMBO	•	•		•			•
MI 3100 SE EurotestEASI	•			•			
MI 3100 s EurotestEASI	•			•			
MI 3125 EurotestCOMBO	•						
MI 3105 EurotestXA	•						
MI 3101 EurotestAT	•						

### STANDARD SET

#### A 1532 XA

- Instrument XA EVSE adapter
- Small soft carrying bag
- Instruction manual



Picture of A 1532 XA set

# Other instruments / adapters / accessories

## A 1507 3-phase active switch adapter



The A 1507 3-Phase Active Switch is an accessory intended for automating the process of electrical safety testing of three phase circuits. In combination with Auto Sequences and one of Metrel's electrical installation safety testers MI 3155 EurotestXD or MI 3152 EurotestXC it is possible to automate the process of 3-phase system testing even further.

### KEY FEATURES

- Banana socket outputs for connection to a 3-phase system;
- Motor driven through Bluetooth communication with Metrel's electrical safety testers;
- Automatic ON/OFF.

### SUPPORTED INSTRUMENTS

- MI 3152 EurotestXC;
- MI 3152H EurotestXC 2.5kV;
- MI 3155 EurotestXD.

### STANDARDS

#### Electromagnetic compatibility:

- EN 61326-1
- EN 61326-2-2

#### Safety:

- EN 61010-1
- EN 61010-2-030
- EN 61010-031

### APPLICATION

#### On-site automated testing of:

- 3-phase systems via the added crocodile clips and probes;
- 3-phase sockets with the use of additional adapters.

#### Supported measurements:

- Voltage and 3-phase sequence;
- Insulation resistances;
- Continuity of protective conductor;
- Resistance to earth;
- Resistance N-PE;
- RCD testing;
- Loop / Line impedances.

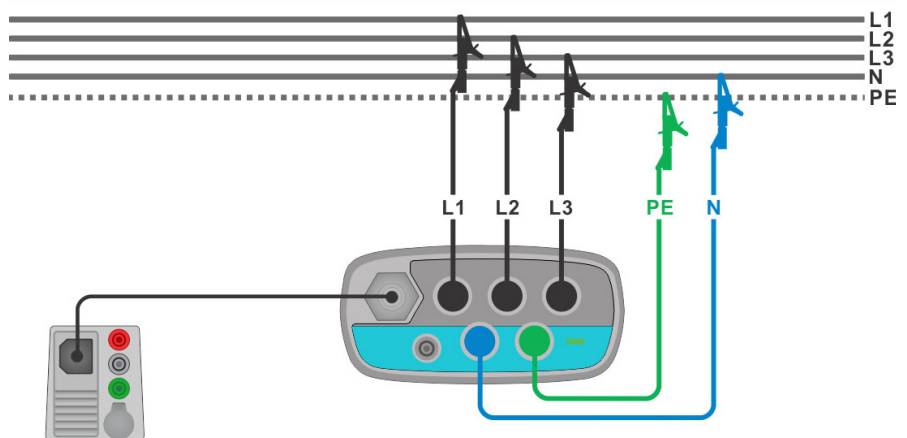

## TECHNICAL DATA

Function	State	Misc.
General	Battery power supply	4.5 V d.c. (3 x 1.5 V battery or accu, size AA)
	Operation	Typical 30 h
	Measuring category	600 V CAT III, 300 V CAT IV
	Degree of protection	IP 40 (case open)
	Dimensions	198 x 131 x 73 mm
	Working temperature range	0 °C ... 40 °C
	Maximum relative humidity	95 %RH (0 °C ... 40 °C), non-condensing
	Working nominal altitude	Up to 3000 m
	Bluetooth module	Class 2
	Working nominal altitude	up to 3000 m
	Bluetooth module	Class 2

### STANDARD SET

#### A 1507

- A 1507 3-Phase Active Switch
- Power supply adapter + 3 NiMH rechargable batteries, type AA
- Test lead, black, (3pcs), green, blue, 1,5 m
- Test tip, black (3pcs), green, blue

- Crocodile clip, black (3pcs), green, blue
- Small soft carrying bag
- Instruction manual
- Calibration certificate



Picture of A 1507

# Other instruments / adapters / accessories

## MI 2093 Line Tracer



The MI 2093 Line Tracer is a universal instrument intended for tracing hidden conductive paths under plasters in walls, floors and ground or for determining one wire in a tuft of wires. Fuses or outlets belonging to a certain loop can be located as well. Line Tracer helps the operator to resolve hidden line problems easily (short circuits, interruptions, breakages).

### MEASURING FUNCTIONS

- Tracing cables in walls, ceilings, floor and ground;
- Tracing live or voltage free cables;
- Locating cable interruptions and short-circuits in cables;
- Locating concealed sockets and distribution boxes;
- Locating fuses and assignment to circuits;
- Determining an individual wire in a bundle of wires;
- Tracing pipe installations and other conductive loops.

### KEY FEATURES

- Detection depth up to 2 m can be

achieved.

- Works on both, energized and non-energized systems.
- The highly sensitive Receiver R10K detects injected signal around the measured line or object.
- Three levels of sensitivity adjustment: low, middle and high. Each level can be additionally precisely adjusted.
- Dual, bar-graph and buzzer indicator ensures indication in dark and noisy environment.

### APPLICATION

- Electrical installations testing;
- Cable networks testing;
- Pipe installations testing;
- Telecommunication systems testing.

### STANDARDS

#### Electromagnetic compatibility:

- IEC/EN 61326

#### Safety:

- IEC/EN 61010-1;
- EN 61010-031

#### STANDARD SET

##### MI 2093

- Transmitter T10K
- Receiver R10K
- Test lead for R10K with built-in resistor and test probe, 1.5 m
- Test lead for T10K, 1.5 m, 2 pcs
- Special selective probe
- Test probe, black, 2 pcs
- Crocodile clip, black, 2 pcs
- Soft carrying bag
- Instruction manual

### TECHNICAL DATA

Transmitter T10K	
Power supply	4 x 1.5 V alkaline or 4 x 1.2 V rechargeable batteries, type AA
Overvoltage category	CAT III / 300 V
Dimensions	80 x 50 x 150 mm
Weight	280 g
Receiver R10K	
Power supply	1 x 9 V battery
Dimensions	45 x 450 x 210 mm
Weight	140 g



Picture of MI 2093 set

# Other instruments / adapters / accessories

## CS 2099 Eurocheck

The CS 2099 Eurocheck is a professional, multifunctional field calibrator intended for use with installation test instruments. Accuracy and functionality of all Metrel and most other manufacturer's installation testers can be verified with the Eurocheck. The CS 2099 Eurocheck can provide a simple field calibration of the most frequently used functions when testing installations.



### MEASURING FUNCTIONS

- Insulation calibration with test voltage up to 1000 V;
- Calibration of low resistance and continuity functions;
- Fault loop and trip-lock RCD impedance functions calibration (all test currents supported on Metrel instruments);
- Calibration of RCD trip-out time function;
- Calibration of line impedance measuring function;
- Calibration of voltage and frequency;
- PE test terminal functional verification;
- Automatic polarity verification.

### APPLICATION

- On-site testing of installation measuring instruments;
- Occasional routine control of the safety testers.

### STANDARDS

#### Electromagnetic compatibility:

- IEC/EN 61326

#### Safety:

- IEC/EN 61010 -1;
- EN 61010-031

### STANDARD SET

#### CS 2099

- Instrument Eurocheck
- Small soft carrying bag
- Instruction manual



Picture of CS 2099 set

### TECHNICAL DATA

Power supply	230 V, 50 / 60 Hz
Overvoltage category	CAT II / 300 V
Dimensions	103 x 61 x 205 mm
Weight	780 g

# Other instruments / adapters / accessories

## A 1199 Ro - Adapter



The Ro - Adapter is a special accessory intended for using only with METREL installation testers. It is designed for measurement of specific earth resistance.

### KEY FEATURES

- Adapter is used for performing 4-wire specific earth resistance measurements;
- Designed for use in conjunction with most Metrel multifunction installation testers (see Selection Guide for EIS Accessories).
- The instrument comes complete with 4-wire test lead, 15 m red extension lead, 2 earthing rods and carrying bag;
- Instruction manual contains step by step guide on how to perform the measurement;
- It is recommended to use A 1199 in combination with 3-wire 20 m earth test lead set (S 2026).

### APPLICATION

- 4-wire earth resistance measurement;
- Specific earth resistance measurement.

### STANDARDS

#### Functionality:

- IEC/EN 61557

#### Other reference standards for testing:

- IEC/EN/HD 60364;
- AS/NZ 3018;
- CEI 64.8;
- BS 7671;
- VDE 0413

#### Electromagnetic compatibility:

- IEC/EN 61326

#### Safety:

- IEC/EN 61010 -1

### STANDARD SET

#### A 1199

- Ro - adapter
- Small soft carrying bag
- Earth test rod, 2 pcs
- Test lead, red, 15 m
- Test lead 4 x 1.5 m
- Instruction manual
- Calibration certificate



Picture of A 1199 set















### TECHNICAL DATA

Power supply	4 x 1.5 V alkaline or 4 x 1.2 V rechargeable batteries, type AA
Overvoltage category	CAT IV / 50 V
Dimensions	100 x 200 x 50 mm
Weight	390 g













# Selection Guide for EIS Accessories

Photo	Part number	Description	Target application	MI 3155	MI 3152	MI 3152H	MI 3102 BT	MI 3102H BT	MI 3100 SE	MI 3125 BT	MI 3108	MI 3109	MI 3121	MI 3122	MI 3123	MI 3110	MI 3143	MI 3144	A 1722	MI 3132	A 1532	A 1507	MI 2093	
	MI 3144	Euro Z 800V	The Euro Z 800 V AC and DC impedance adapter with up to 800 V test voltage and 16 ... 420 Hz range, high current dR300 A with flex clamps, 4-wire, U step-contact and ELR trip-out testing.	•	•	•																		
	MI 3143	Euro Z 440V	The Euro Z 440 V AC impedance adapter with up to 440 V test voltage and 16 ... 420 Hz range, high current dR300 A , 4-wire and U step-contact testing.	•	•	•																		
	A 1632	eMobility Analyser	The A 1632 is used for diagnostic, electrical safety and functional testing of Type 2 EVSE and Mode 2 and Mode 3 EV charging cables.	•	•	•																		
	A 1532	A 1532 EVSE adapter	EVSE (Electric Vehicle Supply Equipment) adapter is a special accessory intended for testing Mode 3 EV supply equipment with a type 2 connector.	•	•	•	•	•	•	•														
	A 1532 XA	A 1532 XA EVSE adapter	EVSE (Electric Vehicle Supply Equipment) adapter is a special accessory intended for testing Mode 3 EV supply equipment with a type 2 connector.	•	•	•	•	•	•	•														
	A 1507	3-phase switch adapter	The A 1507 is an accessory intended for automating electrical safety testing of three phase circuits.	•	•	•																		
	A 1597	Human body resistance probe	The A 1597 is an external adapter used for human body resistance simulation.														•	•						
	A 1740	Calibration box 5kV	Calibration Box for checking insulation measurements in the field (max. test voltage = 5kV).	•	•	•	•	•	•	•														
	A 1199	Ro-adapter	Ro-adapter is intended for performing earth resistance measurement in combination with installation safety tester.	•	•	•	•	•																
	A 1378	EurotestPV Remote	PV remote unit for measurement and logging of irradiance and temperature values.								•	•												
	A 1384	PV Safety Probe	The PV safety probe can safely disconnect the PV installation from the installation in case of a permanent short circuit.								•	•												

Photo	Part number	Description	Target application	MI 3155	MI 3152	MI 3152H	MI 3102 BT	MI 3102H BT	MI 3100 SE	MI 3125 BT	MI 3108	MI 3109	MI 3121	MI 3122	MI 3123	MI 3110	MI 3143	MI 3144	A 1722	MI 3132	A 1532	A 1507	MI 2093	
	CS 2099	Eurocheck	Eurocheck is a professional multifunctional field calibrator intended for use with installation safety testers.	•			•	•	•	•			•	•	•									
	A 1160	Fast charger for 8 AA batteries with a set of 6 NiMH bat., type AA	Fast battery charger for up to 8 pieces of AA rechargeable batteries, and a set of 6 pcs NiMH rechargeable batteries, type AA.	•	•	•	•	•	•	•	•	•	•	•	•	•								•
	A 1169	Fast charger for AA, C, D and 9 V block batteries	Fast battery charger for up to 12 pcs AA, 6 pcs C or D rechargeable batteries, 4 pcs 9 V block batteries.	•	•	•	•	•	•	•	•	•	•	•	•	•								•
	A 1135	Power supply adapter 12 V / 1,2 A	Adapter for fast battery charging.	•	•																			
	A 1548	Power supply adapter 12 V / 0,5 A					•	•	•	•	•	•	•	•	•	•								
	A 1569	Power supply adapter 12 V / 3 A	Adapter for fast battery charging.	•																				•
	A 1567	4400mAh battery pack	Li-Ion Battery pack 7,2V 4400mAh.	•																				•
	A 1568	8800mAh battery pack	Li-Ion Battery pack 7,2V 8800mAh.	•																				•
	S 2080	1,2 V, 2100 mAh AA rechargeable batteries type AA, 6 pcs	A set of 6 pieces of rechargeable batteries type AA.			•	•	•	•	•	•	•	•	•	•	•								
	S 2125	1,2 V, 2400 mAh AA rechargeable batteries type AA, 6 pcs	A set of 6 pieces of rechargeable batteries type AA.	•	•						•													
	A 1427	PV Reference Cell	Irradiance sensor for PV measurements.									•	•											
	A 1400	PV Temperature probe	Temperature probe for measurement of PV module temperature.									•	•											
	A 1172	Luxmeter sensor, type B (PS/2)	Luxmeter sensor, type B, for high-accuracy illuminance measurement e.g. for emergency lightning inspection.	•	•	•	•	•																
	A 1173	Luxmeter sensor, type C (PS/2)	Illuminance probe for light conditions measurements with 0,1Lux resolution.	•	•	•	•	•																

• Option

Photo	Part number	Description	Target application	MI 3155	MI 3152	MI 3152H	MI 3102 BT	MI 3102H BT	MI 3100 SE	MI 3125 BT	MI 3108	MI 3109	MI 3121	MI 3122	MI 3123	MI 3110	MI 3143	MI 3144	A 1722	MI 3132	A 1532	A 1507	MI 2093	
	A 1191	Receiver R10K	Receiver R10K is used for wire tracing, fuse identification and fault finding in low voltage electrical installations.	•	•	•																		
	A 1192	Selective probe for R10K	Very sensitive inductive sensor serves for contactless fuse and cable finding. To be used with A 1191.	•																				•
	A 1067	Test lead for R10K, 1.5 m, with built-in resistor	Test lead with probe enables fast and accurate fuse finding and current circuit allocation. To be used with A 1191.																		•			•
	A 1437	Test lead with Kelvin probe	Test lead with Kelvin probe for fast resistance measurements.																					
	A 1256	Plug commander (straight cable)	Single phase schuko plug commander with TEST and MEM function keys for fast and simple measurements on one phase sockets.																					
	A 1272	Plug commander (for Smartec)	Single phase schuko plug commander with TEST and MEM function keys for fast and simple measurements on one phase sockets.																					
	A 1314	Plug commander	Single phase, 3-pin plug commander with TEST, MEM and function selection buttons and RGB LED status indicator.	•	•	•	•	•	•	•														•
	A 1314 BLK	Plug commander	Single phase, 3-pin plug commander with TEST, MEM and function selection buttons and RGB LED status indicator.	•	•	•	•	•	•	•														•
	A 1401	Tip commander	Single phase, 3-wire tip commander with TEST, MEM and function selection buttons, RGB LED status indicator and front LED lamp.	•	•	•	•	•	•	•														•
	A 1401 BLK	Tip commander	Single phase, 3-wire tip commander with TEST, MEM and function selection buttons, RGB LED status indicator and front LED lamp.	•	•	•	•	•	•	•														•
	A 1244	Tip commander, 2-wire (straight cable)	Single phase 2-wire commander with test tip, TEST and SAVE function keys for installation safety measurements.																					•

• Option











Photo	Part number	Description	Target application	MI 3155	MI 3152	MI 3152H	MI 3102 BT	MI 3102H BT	MI 3100 SE	MI 3125 BT	MI 3108	MI 3109	MI 3121	MI 3122	MI 3123	MI 3110	MI 3143	MI 3144	A 1722	MI 3132	A 1532	A 1507	MI 2093	
	A 1270	Tip commander (for Smartec)	Single phase 2-wire commander with test tip, TEST and MEM function keys for installation safety measurements.											•	•									
	A 1300	Tip commander, 3-wire (for Smartec)	Single phase 3-wire commander with test tip, TEST and MEM function keys for installation safety measurements.												•									
	A 1018	Current clamp (low range, leakage)	High accuracy current clamp 1000 A / 1 A with jaw opening 52 mm and fixed 1.5 m cable for both load and low range / leakage current measurement and for earth resistance measurement as well.	•	•	•	•	•			•	•			•									
	A 1019	Generator clamps	Generator clamp with jaw opening 52 mm in combination with A 1018 for earth resistance measurement without breaking the loop.	•	•	•	•	•								•								•
	A 1281	Current clamp 0,5/5/100/1000 A / 1 V	Four smart ranges current clamp 0,5/5/100/1000 A / 1V, with jaw opening: 5.2 cm; Max. conductor size < 50 mm for measuring alternating currents in low and medium power installations. Current clamp is automatically recognized by the instrument. Clamp does not require external power supply as it is powered by the instrument.																					•
	A 1609	1-phase flexible current clamp	Single phase smart flexible current clamp with three selectable measuring ranges Sensor length: 175 cm; max. conductor size: 540 mm. Current clamp is automatically recognized by the instrument. Clamp does not require external power supply as it is powered by the measuring instrument.																					•
	A 1227	1-phase flexible current clamp 3000/300/30 A / 1 V	Single phase smart flexible current clamp with three selectable measuring ranges Sensor length: 48 cm; max. conductor size: 140 mm. Current clamp is automatically recognized by the instrument. Clamp does not require external power supply as it is powered by the measuring instrument.																					•
	A 1648	Current clamp extension cable, 5 m	Extension cable for current clamps.																					•
	A 1068	Connection cable for clamp, 1.5 m	Connection cable for connecting current clamp on the instrument MI 2093.																					•
	A 1074	Mini current clamp 200 A / 0.2 A	Mini current clamp 200 A / 0.2 A with jaw opening 15 mm for current measurement in confined spaces.				•	•								•								•
	A 1391	AC/DC Current clamp	AC/DC Current Clamp with 40 and 300 A range.	•	•	•	•	•			•	•												

• Option







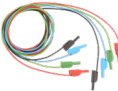





Photo	Part number	Description	Target application	MI 3155	MI 3152	MI 3152H	MI 3102 BT	MI 3102H BT	MI 3100 SE	MI 3125 BT	MI 3108	MI 3109	MI 3121	MI 3122	MI 3123	MI 3110	MI 3143	MI 3144	A 1722	MI 3132	A 1532	A 1507	MI 2093			
	A 1558	Test lead, 4 x 1.5 m	4-wire test lead for continuity and impedance measurements on electrical installations.	•																						
	A 1643	4-Wire extension leads, 5 m	Extension test leads for 4-wire measurements	•													•	•								
	A 1644	4-Wire extension leads, 10 m	Extension test leads for 4-wire measurements	•													•	•								
	A 1011	Test lead, 3 x 1.5 m	3-wire test lead for measurements on single or three phase electrical installations.	•	•	•	•	•	•	•				•		•										
	A 1677	Test lead, 3 x 3 m	3-wire test lead for measuring of single or three phase systems.	•	•	•	•	•	•	•				•		•										
	A 1055	Test lead, 2 x 1.5 m	2-wire test lead for continuity and insulation resistance measurements on electrical installations.	•		•		•					•													
	A 1385	PV fused test lead	Test cable for simultaneous AC/DC power and efficiency measurements of PV inverters.									•	•													
	S 2041	Earth test set, 4-wire, 50 m (for Smartec)	Earth test set for earth resistance measurement on distance up to 50 m; set includes: test lead, 50 m, 2 pcs; test lead 20 m, test lead 4 m; test lead, 1 m, 2 pcs; earth spikes, 4 pcs; soft carrying bag.																							
	S 2026	Earth test set, 3-wire, 20 m	Earth test set for earth resistance measurement on distance up to 20 m; set includes: test lead, 20 m, 2 pcs; test lead, 4.5 m; earth spikes, 2 pcs; soft carrying bag.				•	•	•	•																
	S 2027	Earth test set, 3-wire, 50 m	Earth test set for earth resistance measurement on distance up to 50 m; set includes: test lead, 50 m, 2 pcs; test lead, 4.5 m; test lead, 1 m, 2 pcs; earth spikes, 2 pcs; soft carrying bag.	•	•	•	•	•	•	•																
	A 1530	G clamp	Professional G clamp for perfect contacting, with banana socket.																					•	•	
	A 1022	Earth test rod	Professional earth test rod, 30 cm																						•	•

• Option



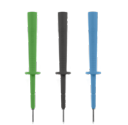

Photo	Part number	Description	Target application	MI 3155	MI 3152	MI 3152H	MI 3102 BT	MI 3102H BT	MI 3100 SE	MI 3125 BT	MI 3108	MI 3109	MI 3121	MI 3122	MI 3123	MI 3110	MI 3143	MI 3144	A 1722	MI 3132	A 1532	A 1507	MI 2093				
	A 1431	EuroLink Android app	EuroLink Android app.				•	•	•	•																	
	A 1012	Test lead, green, 4 m	Test lead for continuity measurements.	•	•	•	•	•	•	•	•	•				•					•						
	A 1154	Test lead, black, 4 m	Test lead for earth and continuity measurements.	•	•	•	•	•	•	•			•		•												
	A 1026	Test lead, red, 20 m	Test lead for continuity measurements.	•	•	•	•	•	•	•			•		•												
	A 1153	Test lead, black, 20 m	Test lead for earth and continuity measurements.	•	•	•	•	•	•	•			•		•												
	A 1620	Test lead 5 m, black	Test lead, black, 5 m, cascade banana plug on both sides.																					•	•		
	A 1621	Test lead 20 m, black	Test lead, black, 20 m, cascade banana plug on both sides.																						•	•	
	A 1527	Test lead 5 m, red, 1.5 mm <sup>2</sup>	Test lead, red, 5 m, cascade banana plug on both sides.																						•	•	
	A 1640	Test lead 20 m, red, 1.5 mm <sup>2</sup>	Test lead, red, 20 m, cascade banana plug on both sides.																							•	•
	A 1630	Test lead 5 m, red	Test lead, red, 5 m, banana plug on both sides.																							•	•
	A 1608	Test lead 20 m, green	Test lead, green, 20 m, cascade banana plug on both sides.																							•	•

• Option

Photo	Part number	Description	Target application	MI 3155	MI 3152	MI 3152H	MI 3102 BT	MI 3102H BT	MI 3100 SE	MI 3125 BT	MI 3108	MI 3109	MI 3121	MI 3122	MI 3123	MI 3110	MI 3143	MI 3144	A 1722	MI 3132	A 1532	A 1507	MI 2093	
	A 1164	Test lead, black, 50 m	Test lead for earth and continuity measurements.	•	•	•	•	•	•	•			•		•									
	A 1509	Test lead 50m black on cable reel	Test lead on a cable reel, black, 50 m, extendable.																		•	•		
	A 1510	Test lead 50m green on cable reel	Test lead on a cable reel, green, 50 m, extendable.																			•	•	
	A 1654	Test lead on a cable reel, 50 m, red, 2.5 mm2, extendable	Test lead on a cable reel, red, 50 m, 2.5 mm2, extendable																					
	A 1660	Extension test leads on reel, 75 m, red, green, 2.5 mm2	Extension leads for High Current grounding and lightning systems testing and Earth Potentials testing.																					
	A 1661	Jumbo case mount for A 1660	Adapter for connection of A 1660 to MI 3144 jumbo case.																					
	S 2009	Test lead set, 2 m, 4 pcs	Set of 4 test leads is intended for two clamp earth resistance measurement to connect current clamps on the instrument.																					
	S 2012	Continuity test lead, 10 m, 2 pcs (red, black)	2 pieces of extension test lead for continuity measurements.	•	•	•	•	•	•	•														•
	S 2025	Test lead, 1.5 m, 2 pcs (black, red)	Connection leads for different measurements.	•	•	•	•	•	•	•														•
	A 1619	Test lead, 2-wire, 2 pcs	Set of 2 test leads bound together. The set is intended for testing with line impedance and loop impedance with impedance adapter.																					
	A 1740	A 1740 Calibration box 5kV	The A 1740 Calibration Box 5kV is intended for calibration purposes insulation resistance testers.	•	•	•	•	•	•	•														
	A 1593	Large Kelvin test clip	Large robust Kelvin crocodile clip for accurate resistance measurements on larger objects.	•																				









• Option



Photo	Part number	Description	Target application	MI 3155	MI 3152	MI 3152H	MI 3102 BT	MI 3102H BT	MI 3100 SE	MI 3125 BT	MI 3108	MI 3109	MI 3121	MI 3122	MI 3123	MI 3110	MI 3143	MI 3144	A 1722	MI 3132	A 1532	A 1507	MI 2093		
	A 1595	Large test crocodile, black	Large robust crocodile clip for resistance measurements on larger objects.	•	•	•											•	•							
	A 1596	Large test crocodile, red		•	•	•												•	•						
	A 1013	Crocodile clip, black	Crocodile clip assures secure and permanent contact during the measurement on bus bars, fixing screws, etc.	•	•	•	•	•	•	•			•	•			•	•		•			•		
	A 1064	Crocodile clip, red		•								•	•	•				•	•		•				
	A 1309	Crocodile clip, green		•	•	•	•	•	•	•	•			•							•				
	A 1310	Crocodile clip, blue		•	•	•	•	•	•	•	•			•											
	A 1547	Crocodile clip, grey																				•			
	A 1014	Test probe, black	Test probe with fi 4 mm connection is suitable for performing measurements both in mains outlets and in situations when no schuko outlet is present.	•	•	•	•	•	•	•			•	•			•	•					•		
	A 1015	Test probe, blue		•	•	•	•	•	•	•	•			•											
	A 1016	Test probe, red		•								•	•	•					•	•					
	A 1062	Test probe, green		•	•	•	•	•	•	•	•	•			•										
	A 1453	Test probe, grey																				•			
	S 2143	Set of test probes CAT II FI 2 black blue green METREL	Test probes with 2 mm diameter test tip to fit testing holes incorporated in the various connectors and to reach measurement locations unreachable by test probes with 4 mm diameter test tip.	•	•	•	•	•	•	•	•	•	•	•	•	•									
	A 1778	Magnetic contact probe	The A 1778 magnetic probe (with a Ø6.6 mm right-angle magnetic adapter and a Ø4 mm socket) is designed for semi-temporary measurement of voltage on steel screw terminal blocks.	•	•	•	•	•	•	•	•	•	•	•											
	A 1201	Insulated rod for CONTINUITY measurement	Insulated rod enables insulation resistance and continuity measurement on hard-to-reach objects, e.g. luminaries.	•	•	•	•	•	•	•	•	•	•	•											
	A 1202	Additional extension part for A 1201	Additional extension part for Insulated rod for CONTINUITY measurement A 1201.	•	•	•	•	•	•	•	•	•	•	•											
	A 1658	Jumbo case for MI 3144	Waterproof, portable case, rated as an IP 65, for outdoor application of electrical safety instruments. This portable lockable case is intended to be used in combination with impedance adapters and its accessories.																•	•					
	A 1736	Carrying case	Carrying case for MI 3155 EurotestXD together with the Euro set of accessories – for earth resistance testing with or without stakes, testing of impedances, insulation and safety devices in installations, functional tests like power and harmonics, and much more. Some extra space is left available for any additional equipment the user may want to bring along.	•	•	•																			
	A 1737	Carrying case	Case with foam inserts with slots for a Eurotest multifunctional electrical installation safety tester and MI 3309 BT DeltaGT. Multiple possible instrument & accessory combinations. We recommend the MI 3110 EurotestIT, MI 3309 DeltaPAT, MD 9231 AC/DC current clamp and A 1207 three phase adapter combination.	•	•	•	•	•	•	•			•	•	•	•									
	A 1738	Carrying case	It can fit for a Eurotest multifunctional electrical installation safety tester and either an A 1532 EVSE adapter or A 1532 XA EVSE adapter. It has an additional large slot for the tester's accessories or other equipment.	•	•	•	•																•		

• Option

Photo	Part number	Description	Target application	MI 3155	MI 3152	MI 3152H	MI 3102 BT	MI 3102H BT	MI 3100 SE	MI 3125 BT	MI 3108	MI 3109	MI 3121	MI 3122	MI 3123	MI 3110	MI 3143	MI 3144	A 1722	MI 3132	A 1532	A 1507	MI 2093	
	S 2138	S 2138 Set of wheels for carrying cases A 1736, A 1737, A 1738	Wheels and trolley that can be added to carrying cases for easier transport.	•	•	•	•	•	•	•			•	•	•	•								
	A 1551	Carrying bag (L)	Small carrying bag for transport and storage of test instrument and all belonging standard set and euro set accessories.	•																	•			
	A 1552	Carrying bag (XL)	Large carrying bag for transport and storage of test instrument and all belonging standard set and euro set accessories.	•																	•			
	A 1289	Carrying bag (M)	Large soft carrying bag for transport and storage of test instrument and belonging accessories.	•	•	•	•	•	•	•			•	•	•	•								
	A 1020	Small soft carrying bag	Small soft carrying bag for transport and storage of test instrument or accessories.																				•	
	A 1271	Carrying bag (S)								•			•	•	•									
	A 1302	Set of carrying straps	Set of carrying straps for carrying the measuring instrument around the neck allowing free hand use of the tester.						•															
	A 1707	Set of carrying straps		•	•	•	•	•	•		•	•												
	A 1303	Soft hand strap	Soft hand strap for holding the instrument.							•			•	•	•									
	A 1376	3-phase adapter 16 A male / 16 A female, 5 pin, 2 m	3-phase test adapter, for testing of 3 phase extension leads in combination with A 1322 / Active 3-phase Adapter.																		•			
	A 1724	3-ph Y-CEE 16 A cable, 2 m	3-phase adapter for testing 3-phase PRCDs																		•			
	A 1725	3-ph Y-CEE 32 A cable, 2 m	3-phase adapter for testing 3-phase PRCDs																		•			
	A 1110	Three phase adapter	3-phase test adapter for installation safety testing on 3-phase sockets type 16 A 3CEE.	•	•	•	•	•	•	•					•									

Photo	Part number	Description	Target application	MI 3155	MI 3152	MI 3152H	MI 3102 BT	MI 3102H BT	MI 3100 SE	MI 3125 BT	MI 3108	MI 3109	MI 3121	MI 3122	MI 3123	MI 3110	MI 3143	MI 3144	A 1722	MI 3132	A 1532	A 1507	MI 2093	
	A 1111 A 1215	Three phase adapter with switch	3-phase adapter with selection switch for installation safety testing on 3-phase sockets type 16 A 3CEE. The adapter allows seamless switching between measurements.	•	•	•	•	•	•	•				•										
	A 1641	Adapter CEE 5-P 16A (male) / Schuko plug	3-phase adapter for testing 3-phase sockets type 16 A CEE with support of the A 1507 3-Phase Active Switch.																					•
	A 1642	Adapter CEE 5-P 32A (male) / Schuko plug	3-phase adapter for testing 3-phase sockets type 32 A CEE with support of the A 1507 3-Phase Active Switch.																					•
	A 1436	Bluetooth dongle	External Bluetooth adapter for wireless connection between Metrel's instruments and Smart phones, tablets and PCs.					•			•	•												
	A 1105	Barcode scanner	Barcode scanner for identification of barcode labelled installation structure elements like sockets, switches, fuses, switchboards, etc.	•	•	•					•	•												
	A 1652	Barcode scanner (Bluetooth)	Barcode scanner for identification of barcode labelled appliances.	•	•	•																		
	A 1653	QR / Barcode scanner (Bluetooth)	QR / Barcode scanner for identification of barcode labelled appliances.	•	•	•																		
	AM 1337	RFID Reader	RFID reader.								•	•												



# Content

## High Voltage Insulation / Continuity / Earth / Transformer

Electrical Installation Safety	1.1 - 1.72
<b>HIGH VOLTAGE INSULATION / CONTINUITY / EARTH / TRANSFORMER</b>	<b>2.1 - 2.48</b>
Appliance / Machine / Switchboard Safety	3.1 - 3.52
Power Quality Analysis	4.1 - 4.26
Equipment for laboratories and Schools	5.1 - 5.16
Multimeters / Clamp meters / Voltage testers / Thermal cameras	6.1 - 6.44
Software	7.1 - 7.19
<b>GOOD TO KNOW</b>	
Testing the HV, Step / Contact Voltage and Earth Resistance	2.02
<b>EARTH TESTER</b>	
Selection Guide for Earth Tester	2.06
MI 3290 Earth Analyser	2.07
MI 3288 Earth Insulation Tester	2.10
MI 3295 Step Contact Voltage Measuring System	2.12
<b>TRANSFORMER TESTERS</b>	
Selection Guide for Transformer testers <b>NEW</b>	2.15
MI 3281 WR Analyser <b>NEW</b>	2.16
MI 3280 DT Analyser	2.18
<b>CONTINUITY TESTERS</b>	
Selection Guide for Continuity Insulation Testers	2.21
MI 3252 MicroOhm 100A	2.22
MI 3250 MicroOhm 10A	2.24
MI 3242 MicroOhm 2A	2.26
<b>HIGH VOLTAGE INSULATION TESTERS</b>	
Selection Guide for HV Insulation Testers	2.28
MI 3210 TeraOhmXA 10 kV	2.30
MI 3209 TeraOhmLT 10 kV	2.32
MI 3205 TeraOhmXA 5 kV	2.34
MI 3201 TeraOhm 5 kV Plus	2.36
MI 3202 GigaOhm 5 kV	2.38
MI 3121H 2,5 kV Insulation / Continuity	2.40
<b>SELECTION GUIDE FOR HV ACCESSORIES</b>	<b>2.42</b>

## Good to know

# Testing the HV, Step / Contact Voltage and Earth Resistance

### Find out more about Insulation measurement techniques

Insulation is a material property and is measured as insulation resistance. Characteristics of insulation tend to change through time, normally getting worse by ageing. Various physical phenomena have influence on insulation characteristics, like temperature, dirt, humidity, mechanical and electrical stresses, high-energy radiation, etc. Harsh installation environments, especially those with temperature extremes and / or chemical contamination, cause further deterioration.

Safety, operability and reliability are the most important parameters of electrical device containing insulation and this is the reason why insulation has to be measured. Insulation is measured in the initiating phase of electrical device and also later during maintenance works or repairing, and measurements are of simple and diagnostic type.

### Basics of insulation measurements

According to Ohms law,

$$I = \frac{U}{R}$$

the current does not depend on time. But a simple measurement of insulation resistance shows that the current depends on time. The reasons for such behaviour of the current are different phenomena in insulation material after a voltage is applied. A typical insulation model is presented in figure below.

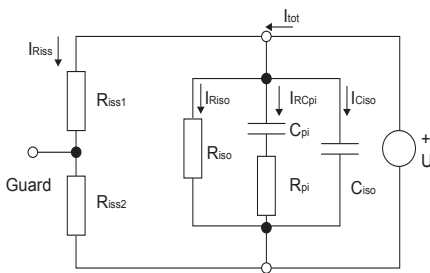

Insulation resistance and capacitance model, partial and total currents

U	Applied test voltage
Riss1 & Riss2	Surface leakage resistances
Riso	Insulation resistance
Ciso	Insulation capacitance
Rpi	Polarization resistance
Cpi	Polarization capacitance

The total current  $I_{tot}$  comprises of four partial currents.

$I_{tot}$	Total current
$I_{Riss}$	Surface leakage current
$I_{Riso}$	Insulation leakage current
$I_{RCpi}$	Polarization absorption current
$I_{Ciso}$	Capacitance charging current

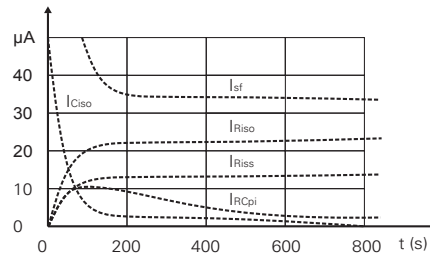

Typical current / time diagram for a real voltage source

In practice the insulation resistance measurement instrument does not include an ideal voltage source. At the start all available instrument power is used to charge the capacitor  $C_{iso}$  for short period. The voltage on connection points drops because of this.

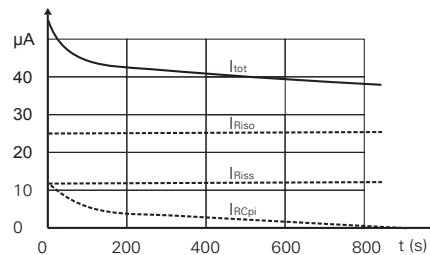

Current diagram for an ideal voltage source

When DC voltage is suddenly applied to the insulation, the test current will start at a high value, gradually decrease with time, and finally level off to a stable value. The leakage current does not change with time, and this current is the primary factor on which the insulation quality may be judged.

### Types of insulation testing

Various types of insulation testing are used to determine insulation characteristics.

### DC voltage testing and AC voltage testing AC testing

AC testing is more suitable for performing withstanding or dielectric tests. While DC test gives more qualitative picture about the tested insulation.

### Spot reading test

This is the simplest and fastest way of insulation resistance testing. Unfortunately only one test, with no prior tests, can be only a rough guide as to how good or bad the insulation is. In this test the instrument is connected across the insulation of the tested item. A test voltage is applied for a fixed period of time; usually a reading is taken after 1 minute as can be seen in figure.

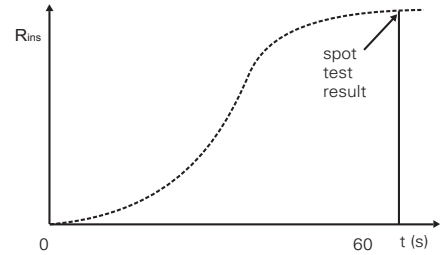

Typical insulation resistance/time diagram for a spot reading test

The spot reading test should only be carried out when the insulation temperature is above the dew point.

*METREL's hint: The lower limit of insulation resistance may often be established according to the one mega-ohm rule: Insulation resistance should be at least 1 MΩ for each kilovolt of operating voltage, but not less than 1 MΩ (e.g. a motor rated at 5 kV working voltage should have a minimum resistance of 5 MΩ).*

### Time rise method / polarization index / dielectric absorption ratio

When test voltage is applied a bad insulation causes drop of the value  $R_{iso}$  and the increasing in the insulation leakage current  $I_{Riso}$ . The absorption current is masked by a high insulation leakage current. The insulation leakage current stays at a fairly constant value and the resistance reading stays low. A good insulation shows continuous increasing of the resistance over a period. This is caused by the absorption that can be clearly seen. The absorption effect lasts far longer than the time required for charging the capacitance of the insulation.

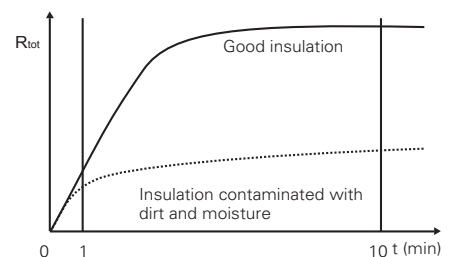

Time diagrams of good and bad insulation tested with the time-rise method

The result of this measurement is polarization index (PI), which is defined as the ratio of measured resistance in two time slots (typically the ratio is 10 min value to 1 min value at a continuous measurement).

PI value	Tested material status
1 - 1.5	Not acceptable (older types)
2 - 4 (typically 3)	Considered as good insulation (older types)
4 (very good insulation)	Modern type of good insulation systems

Typical values of polarization index

$$PI = \frac{R_{tot}(10 \text{ min})}{R_{tot}(1 \text{ min})}$$

The results of this method don't depend on temperature and the method can give a conclusive information without comparing records of past tests.

Dielectric absorption ratio (DAR) is similar to the polarization index method. The only difference are periods for capturing the results which are usually 30 s (or 15 s) and 1 minute.

DAR value	Tested material status
< 1	Bad insulation
$1 \leq DAR \leq 1.25$	Acceptable insulation
> 1.4	Very good insulation

Typical values for dielectric discharge

$$DAR = \frac{R_{tot}(1 \text{ min})}{R_{tot}(30 \text{ s})}$$

### Dielectric discharge

It is difficult to determine the polarization index if polarization absorption current  $I_{RCpi}$  is small compared to the others. Rather than measuring the polarization current during an insulation test, the dielectric discharge (DD) test can be performed. DD test is carried out after the completion of the insulation resistance measurement. Typically the insulation material is left connected to the test voltage for 10 ... 30 min and then discharged before the DD test is carried out. After 1 min a discharge current is measured to detect the charge re-absorption of the insulation material. A high re-absorption current indicates contaminated insulation (mainly based on moisture).

DD value	Tested material status
> 4	Bad
2 - 4	Critical
< 2	Good

Values of dielectric discharge

$$DD = \frac{I_{dis}(1 \text{ min})}{U C_{iso}}$$

$I_{dis}(1 \text{ min})$	discharging current measured 1 min after the voltage was switched off
U	test voltage
$C_{iso}$	capacitance of tested object

Typical values of dielectric discharge

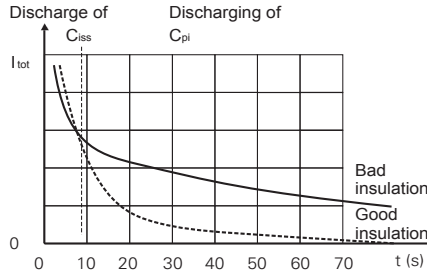

The current/time diagram of a good and bad insulation tested with dielectric discharge method

The dielectric discharge test is very useful for testing a multi-layer insulation.

### Step voltage insulation resistance test

Testing with a voltage far below the one expected in service often reveals moisture and dirt in insulation, whereas effects of ageing or mechanical damage of a fairly clean and dry insulation may not be revealed at such low stress. The step voltage method is very useful when testing with an instrument that has a lower test voltage than the rated test voltage of the tested item. In other words, step voltage test gives us useful results even in case we are not able to stress insulation with nominal electrical voltages.

The device under test is exposed to different test voltages that are applied in steps. The voltage starts at the lowest value and increases with defined steps up to the highest level.

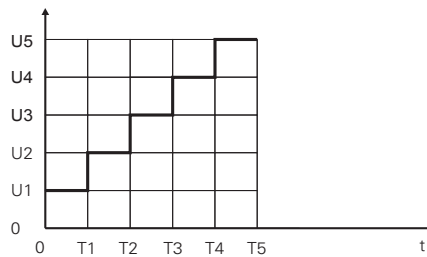

Typical measuring procedure for step voltage measurement

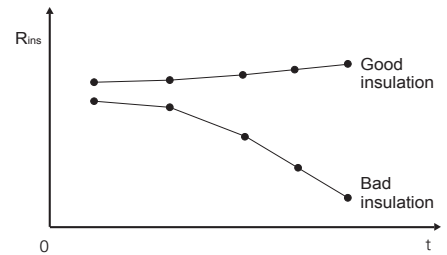

Typical step voltage measurement results

The shape of the curve represents the quality of insulation:

- The resistance of a damaged insulation will rapidly decrease.
- A good insulation has approximately constant resistance at all voltages.

### Withstanding voltage test

The withstanding voltage test is one of the basic insulation tests. Its principle is very simple - the voltage is stressing the device under test until the required test time or breakdown of insulation is reached.

The time gradient of increasing voltage, maximum voltage and the time of maximum test voltage are very important and depend on the type of device under test. These parameters are defined in adequate standards. The indication of a breakdown is a sudden increase in the current through insulation, beyond the predefined limit.

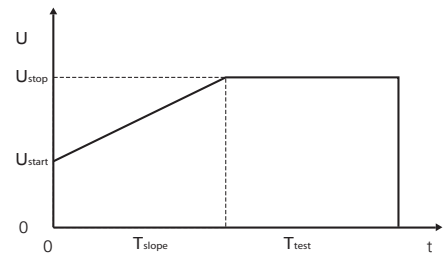

Measuring procedure for withstanding voltage measurement.

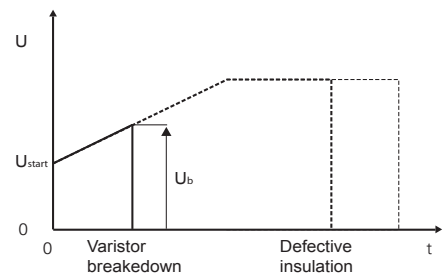

Measuring procedure for withstanding voltage measurement.

**Typical connections for:**

**Power cables**

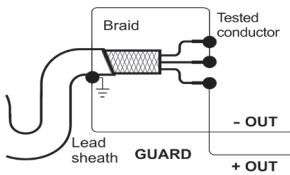

Measurement of insulation resistance of cable between one conductor against other conductors including lead sheath

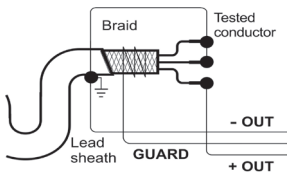

Measurement of insulation resistance of cable between one conductors against other conductors and lead sheath using the guard terminal to avoid leakage effects at the end of cable

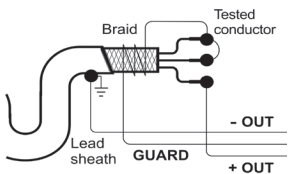

Measurement of insulation resistance of a cable between a conductor and lead sheath

**Control and communication cable**

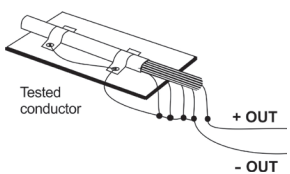

Measurement of insulation resistance between one lead of communication cable against other leads and sheath

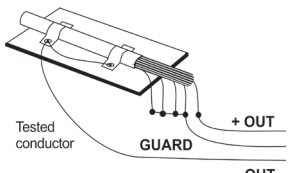

Measurement of insulation resistance of communication cable using the guard terminal. Resistance is measured between a lead and sheath

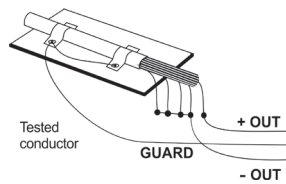

Measurement of insulation resistance of communication cable using the guard terminal. Resistance is measured between one lead and other leads

**Home appliances and similar electrical devices**

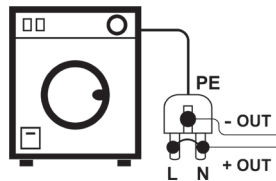

Measurement of household device, protection class I and class II

**Induction motor**

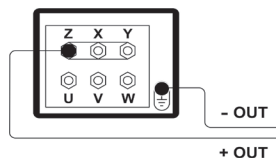

Measurement of insulation resistance of induction motor between all three phases against metal enclosure

**Power transformer**

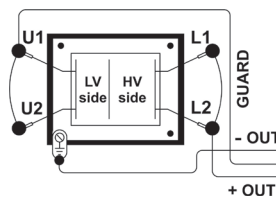

The simplest measurement of insulation resistance of transformer

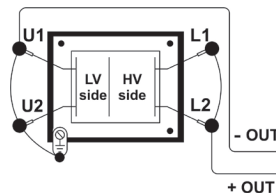

Measurement of insulation resistance on one HV winding against metal enclosure

**Earthing**

Correct earthing of exposed conductive parts of the object assures that the voltage on them stays below dangerous level in case of a fault. If fault happens a fault current will flow through the earthing electrode.

A typical voltage distribution occurs around the electrode (the "voltage funnel"). Fault currents close to power distribution objects (substations, distribution towers, plants) can be very high, up to 200 kA. This can result in dangerous step and contact voltages. If there are underground metal connections (intended or unknown) the voltage funnel can get atypical forms and high voltages can occur far from the point of failure. Therefore the voltage distribution in case of a fault around this objects must be carefully analysed.

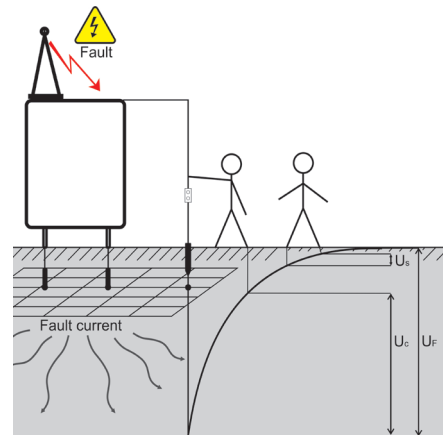

Dangerous voltages on a faulty earthing system

Standard IEC 61140 defines following maximum allowed time / contact voltage relations:

Maximum time of exposure	Voltage
> 5 s to ∞	$U_c \leq 50 \text{ V}_{AC}$ or $\leq 120 \text{ V}_{DC}$
< 0.4 s	$U_c \leq 115 \text{ V}_{AC}$ or $\leq 180 \text{ V}_{DC}$
< 0.2 s	$U_c \leq 200 \text{ V}_{AC}$
< 0.04 s	$U_c \leq 250 \text{ V}_{AC}$

Maximum time durations vs fault voltage

For a longer exposure the touch voltages must stay below 50 V.

During the measurement a test current is injected into the earth through an auxiliary probe. A higher injected current improves the immunity against spurious earth currents.



### Step voltage measurement

The measurement of step voltage is performed between two ground points at a distance of 1 m. The 25 kg measuring probes simulates the feet. The voltage between the probes is measured by a voltmeter with an internal resistance of 1 k $\Omega$  that simulates the body resistance.

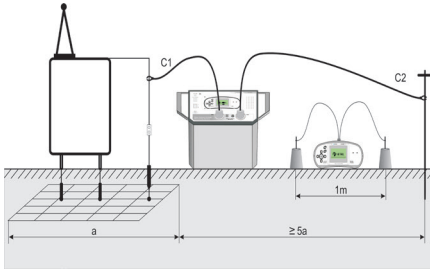

Step voltage measurement

### Contact voltage measurement

The measurement of contact voltage is performed between an earthed accessible metal part and ground. The voltage between the probes is measured by a voltmeter with an internal resistance of 1 k $\Omega$  that simulates the body resistance.

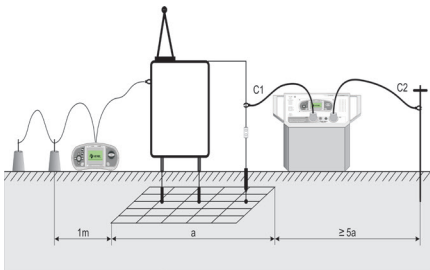

Contact voltage measurement

### Earth resistance measurement

For the earthing resistance test a voltage and current probe (serves as auxiliary earth) are used. Because of the voltage funnel it is important that the test electrodes are placed correctly.

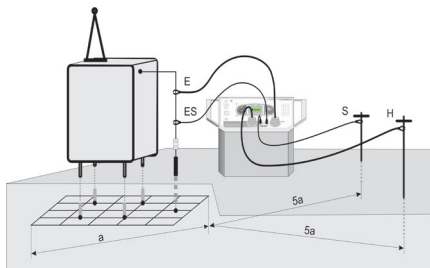

Earth resistance measurement

### Specific earth resistance

For the specific earth resistance the test current is injected through two current probes (C1/H and C2/E).

The voltage probes S and ES must be placed between the current probes (equidistance 'a' between probes must be considered). Using different distances between the test probes means that the material at different depths is measured. By increasing the distances 'a' a deeper layer of ground material is measured.

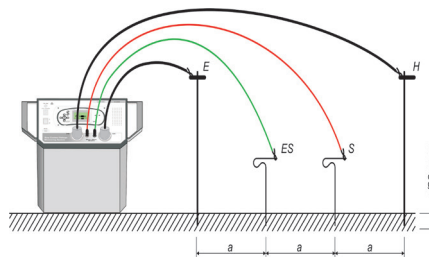

Specific earth resistance measurement

### Low Resistance Measurement

#### Four-wire Kelvin method

When measuring resistance <20  $\Omega$  it is advisable to use a four-wire Kelvin measurement technique for achieving high accuracy. By using this type of measurement configuration the test lead resistance is not included in the measurement, and the need for lead calibrating and balancing is eliminated.

**Typical connections for:**

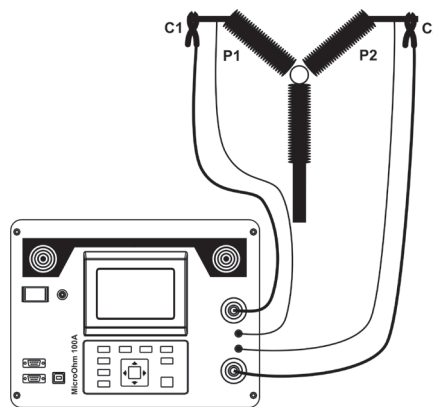

Circuit breaker connection

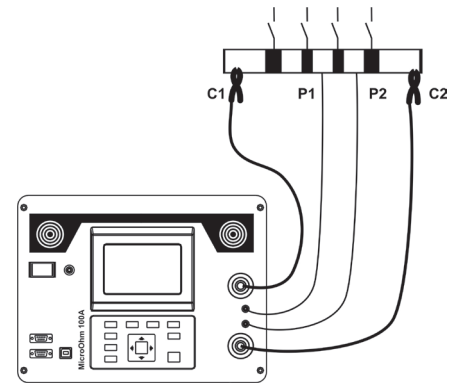

Bus bar connection

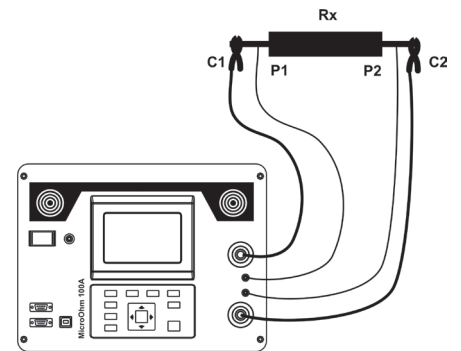



Connecting instrument to the measured device

The measuring current is passed through the unknown resistance Rx using the C1 and C2 leads. The placing of these leads is not critical but should always be outside the P1 and P2 leads. The Volt drop across the Rx is measured across P1 and P2 and these should be placed exactly at the points to be measured.

# Earth testers

## Selection Guide for Earth Testers

FEATURES	Description	MI 3290 GX Earth Analyser	MI 3290 GF Earth Analyser	MI 3290 GP Earth Analyser	MI 3290 GL Earth Analyser	MI 3288 Earth - Insulation Tester	MI 3295 Step Contact Voltage Measuring System
							
<b>EARTH RESISTANCE</b>	2/3/4 wire method	• / • / •	• / • / •	• / • / •	• / • / •	• / • / •	- / - / •
	Fixed freq./sweep	55 ... 15 kHz	55 ... 15 kHz	55 ... 15 kHz	55 ... 15 kHz	55 ... 164 Hz	55 Hz
	Range @ 55 Hz	0 ... 20 kΩ	0 ... 20 kΩ	0 ... 20 kΩ	0 ... 20 kΩ	0,010 ... 20 kOhm	0 ... 200 Ω
	1 Clamp (Selective method)	•			•	•	
	Range @ 55 Hz	0 ... 20 kΩ			0 ... 20 kΩ	0,010 ... 20 kOhm	
	2 Clamp (Stakeless method)	•			•	•	
	Range @ 164 Hz	0 ... 100 Ω			0 ... 100 Ω	0 ... 100 Ω	
	1 Flex/4Flex Clamp	• / •		• / •			
	High frequency method	25 kHz			25 kHz		
	Range	0 ... 300 Ω			0 ... 300 Ω		
Pulse method	10/350 μs			10/350 μs			
Range	0 ... 200 Ω			0 ... 200 Ω			
<b>SPECIFIC EARTH RESISTANCE</b>	Wenner / Schlumberger	• / •	• / •	• / •	• / •	• / •	• / -
	Range	0 ... 20 kΩm	0 ... 20 kΩm	0 ... 20 kΩm	0 ... 20 kΩm	0 ... 20 kΩm	0 ... 100 kΩm
<b>EARTH POTENTIAL</b>	Earth Potential	•	•			•	
	Step & Touch voltage	•	•			•	•
	Max. test current	> 220 mA	> 220 mA			> 120 mA	55 A
<b>RESISTANCE</b>	DC resistance	•	•			•	
	Range/max. res. @200mA	0 ... 2 kΩ/10mΩ	0 ... 2 kΩ/10mΩ			0,020 Ohm ... 2 kΩ/1mΩ	
	@7mA	0 ... 20 kΩ/0,1Ω	0 ... 20 kΩ/0,1Ω			0 ... 999 kΩ/0,1Ω	
	AC impedance	•	•				
	Range/max. res.	0 ... 20 kΩ/10mΩ	0 ... 20 kΩ/10mΩ				
<b>AC CURRENT</b>	Iron clamps	•			•	•	
	Flex clamps	4 pcs (GX4) 1 pce (GX1)		1 pce		•	

# Earth testers

## MI 3290 Earth Analyser



MI 3290 Earth Analyser is a portable, battery or mains powered test instrument with excellent IP protection (IP 54 open case), intended for measurement of earth resistance, specific earth resistance and earth potential of various energetic and non-energetic objects. The user can choose between different methods from classic 3 wire earth resistance measurement up to one or four clamp method for measurement of pylons. He has a choice of measurement methods with different frequency methods: single frequency or frequency sweep from 55 Hz to 15 kHz, HF method with 25 kHz and pulse method simulating the lightning strike. High electrical noise immunity makes this instrument best suited for industrial environment. Instrument is available in multiple sets which are a combination of different accessories and measurement functions.

High Voltage Insulation / Continuity / Earth / Transformer

### MEASURING FUNCTIONS

- Earth Resistance 2,3,4 -pole;
- Selective Earth Resist (1 x clamp);
- Earth Resistance (2 x iron clamps);
- Specific Earth Resistance (Wenner and Schlumberger method);
- HF-Earth Resistance (25 kHz, acc. to IEEE\_Std 81);
- Earth Resistance of mono pylons with 10 m flex clamp;
- Earth Resistance of multi-leg pylons with up to four flex clamps;
- Current measurement (Iron, flex clamps);
- Low Ohm measurement 7 mA and 200 mA;
- Earth Potential;
- Step and contact measurements;
- Impulse Earth measurement 10/350  $\mu$ s.

### KEY FEATURES

- Possibility of performing all types of earth measurements with a single instrument.
- Analysis of earth impedance as a function of the frequency due to a wide measurement frequency band (55 Hz ... 15 kHz).

- Earth measurements on pylons with protective earth cable connected.
- Measurement on mono towers and 4-leg tower.
- A wide variety of measuring clamps: from iron clamps to flex clamps with 10 m length.
- HF-Earth resistance measurement (acc. to IEEE\_Std 81).
- Sweep mode Z(f) on screen.
- High resolution colour touch screen, 4.3" TFT.
- Floating Mains (universal 90 ... 260 V AC) or battery powered (built in fast charger).
- High degree of protection: IP 65 case closed, IP 54 case open.
- Checkbox - different self-check methods.
- DC resistance measurements.
- Impulse impedance measurement for simulating the lightning strike.
- Support for single or automated measurements.
- PC SW for measurement pre and post processing: preparation of the test structure, result download, tree-view, table view and graphical view, storing and printing.

### APPLICATION

#### Measurement of protective earthing of:

- Mono and multi-leg pylons with protective earth cable connected;
- MV to LV transformer stations;
- Ski lifts, radio towers;
- Solar Power plants, wind and water turbine;
- Industrial areas.

### STANDARDS

#### Functionality

- EN 61557 - 5
- IEEE 80 - 2000
- IEEE 81 - 2012
- IEEE 142
- IEEE 367 - 2012

#### Electromagnetic compatibility

- EN 61326

#### Safety

- EN 61010 - 1
- EN 61010 - 2 - 030 c
- EN 61010 - 2 - 032
- EN 61010 - 031

## TECHNICAL DATA

Method	Additional info	Measurement range	Uncertainty
Earth resistance 2, 3, 4 -pole	Open-terminal test voltage 20 or 40 VAC Short-circuit test current > 220 mA Test frequency 55 Hz...329 Hz 659 Hz ... 2.63 kHz 3.29 kHz ... 15 kHz	0.010 Ω ... 19.99 kΩ 0.00 Ω ... 1.999 kΩ 0.00 Ω ... 199.9 Ω	±(3 % of reading + 3 digits) ±(5 % of reading + 3 digits) ±(8 % of reading + 3 digits)
Selective earth resistance with iron clamp	Open-terminal test voltage 40 VAC Short-circuit test current > 220 mA Test frequency 55 Hz ... 329 Hz 659 Hz ... 1.50 kHz	0.010 Ω ... 19.99 kΩ 0.00 Ω ... 1.999 kΩ	±(8 % of reading + 3 digits)
Selective earth resistance of pylons with flex clamp	Open-terminal test voltage 40 VAC Short-circuit test current > 220 mA Test frequency 55 Hz...329 Hz 659 Hz ... 1.50 kHz Passive mode	0.010 Ω ... 19.99 kΩ 0.00 Ω ... 1.999 kΩ 0.00 Ω ... 19.99 kΩ	±(8 % of reading + 3 digits)
Earth resistance with two iron clamps	Test frequency 82 Hz ... 329 Hz	0.00 Ω ... 9.99 Ω 10.0 Ω ... 49.9 Ω 50.0 Ω ... 100 Ω	±(5% of reading + 2 digits) ±(10 % of reading + 2 digits) ±(20 % of reading)
Specific earth resistance ro Wenner and Schlumberger method	Open-terminal test voltage 20 or 40 V AC Short-circuit test current >220 mA Test frequency 164 Hz	0.00 Ωm ... 19.99 kΩm	calculated value (consider uncertainty of 4 - pole measurement)
Earth Potential	Open-terminal test voltage 40 V AC Short-circuit test current >220 mA Test frequency 55 ÷ 329 Hz	0.0 mV ... 49.9 V	calculated value (consider uncertainty of 3 - pole measurement)
HF-Earth Resistance 3 pole	Open-terminal test voltage 40 VAC Short-circuit test current >40 mA Test frequency 25.000 Hz	0.00 Ω ... 19.9 Ω 20.0 Ω ... 299 Ω	±(3 % of reading + 2 digits)
Impulse Earth Resistance	Open-terminal test voltage ~120 V peak Short-circuit test current ~6 A peak Impulse waveform 10 / 350 µs	0.0 Ω ... 199 Ω	±(8 % of reading + 8 digits)
DC Resistance RLOW	Test current 200 mA	0.00 Ω ... 1.99 kΩ	±(2 % of reading + 2 digits)
DC Resistance CONT	Test current 7 mA	0.00 Ω ... 19.9 kΩ	±(3 % of reading + 2 digits)
AC Impedance	Test frequency 55 Hz ... 15 kHz	0.00 Ω ... 19.99 kΩ	±(3 % of reading + 2 digits)
Current RMS (Iron Clamp)	Nominal frequency 45 Hz ...1.5 kHz	1.0 mA ...7.99 A	±(2 % of reading + 3 digits)
Current RMS (Flex Clamp)	Nominal frequency 45 Hz ...1.5 kHz	10 mA ... 49.9 A	±(8 % of reading + 3 digits)
Battery power supply	14.4 V DC (4.4 Ah Li-ion)		
Mains power supply	90-260 VAC, 45-65 Hz, 100 VA (300 V CAT II)		
Degree of protection	IP 65 (case closed) IP 54 (case open)		
Dimensions	360 x 160 x 330 mm		
Display	Colour TFT display, 4.3 inch, 480 x 272 pixels		
Communication	USB, BT		
Memory	>1GB		

## SET SPECIFICATION



Licence key	GX	GL	GF	GP
<b>Measurement methods</b>				
Ground Z 2-pole	•	•	•	•
Ground Z 3-pole	•	•	•	•
Ground Z 4-pole	•	•	•	•
Single/multi/sweep frequency	•	•	•	•
Wenner 4-pole	•	•	•	•
Schlumberger 4-pole	•	•	•	•
Selective (iron clamp)	•	•		
Stakeless 2-clamps	•	•		
Transient Impedance	•	•		
HF 25 kHz Impedance	•	•		
Step / Touch	•		•	
Voltage potential	•		•	
Low Impedance 4-point	•		•	
Low Resistance 200 mA	•		•	

	GX	GL	GF	GP
Tower Passive one rod / Flex clamps	•			•
Tower FOP / 1xFlex clamp	GX1			•
Tower FOP / 4xFlex clamp	GX4			Option
Mono Tower FOP / Flex clamp	•			•
<b>Measurement accessory</b>				
Current earth spike, 90 cm, 2 pcs	•	•	•	•
Potential earth spike, 50 cm 2 pcs				
G clamp				
Shielded test lead on reel, 75 m				
Test lead on reel 50 m, 3 pcs (black, green, blue)				
Test lead, 5 m, 2 pcs (blue, red)				
Set of test probes, crocodile clip and 2 m test lead, 4 pcs				
Flex clamp 5 m with 15 m shielded cable	4 pcs (GX4) 1 pce (GX1)			1 pce
Iron clamp, 2 pcs	•	•		
Kelvin clamp with 2,5 m cable, 2 pcs	•		•	
Step Contact Meter Measuring Set	•		•	

## ORDERING INFORMATION

### All model versions include following accessory:

- Instrument MI 3290
- Current earth spike 90 cm, 2 pcs
- Potential earth spike 50 cm, 2 pcs
- Connection lead black 2 m
- Test lead 5 m blue
- Test lead 5 m red
- Test lead 50 m black on cable reel
- Test lead 50 m green on cable reel
- Test lead 50 m blue on cable reel
- Shielded test lead 75 m on reel
- G clamp
- Set of test probes, crocodile clip and 2 m test lead, 4 pcs
- Bag for accessories



### **MI 3290 GX1**

- Licence GX
- Iron clamp A 1018 with 3,5 m test lead
- Iron clamp A 1019
- Flex clamp 5 m with 15 m shielded cable
- Kelvin clamp with 2,5 m cable, 2 pcs
- Voltmeter MI 3295M with 2 wire test lead
- Soft carrying bag
- Step voltage test plate, 2 pcs
- NiMH battery cells, type AA, 6 pcs
- Power supply adapter
- Bag for accessories

### **MI 3290 GX4**

- MI 3290 GX1
- Flex clamp 5 m with 15 m shielded cable, 3 pcs
- Bag for accessories



Picture of MI 3290 GX4 set

### **MI 3290 GL**

- Licence GL
- Iron clamp A 1018 with 3,5 m test lead
- Iron clamp A 1019



Picture of MI 3290 GL set

### **MI 3290 GF**

- Licence GF
- Kelvin clamp with 2,5 m cable, 2 pcs
- Voltmeter MI 3295M with 2 wire test lead
- Soft carrying bag
- Step voltage test plate, 2 pcs
- NiMH battery cells, type AA, 6 pcs
- Power supply adapter



Picture of MI 3290 GF set

### **MI 3290 GP**

- Licence GP
- Flex clamp 5 m with 15 m shielded cable
- Bag for accessories



Picture of MI 3290 GP set

# Earth testers

## MI 3288 Earth Insulation Tester



MI 3288 Earth Insulation tester is a portable, battery powered test instrument with excellent protection and designed for high altitude (300 V CAT III at 4000 m), intended for measurement of earth resistance, specific earth resistance, earth potential, step and touch voltages, insulation resistance and continuity of protection conductors of various energetic and non-energetic objects. Tester enables 4-wire earth resistance measuring method in combination with one clamp, two clamps earth resistance measurement, 4-wire specific earth resistance measurement and TRMS current measurement.

With the option to measure earth potential, step and touch voltage it becomes a very universal tester. Besides the breakdown voltage of overvoltage protection devices can be checked by the instrument. All the results can be saved on the instrument and then downloaded with the help of the PC software Metrel ES Manager to the computer for evaluation and report generation after testing.

### MEASURING FUNCTIONS

- Earth Resistance 2/3/4 - pole;
- Selective Earth Resistance (1 x clamp);
- Specific Earth Resistance Ro **Wenner and Schlumberger method**;
- Earth Resistance with 2 iron clamps;
- Earth Potential;
- Step and touch voltage measurement with external P/S probe;
- **Insulation resistance with DC voltage from 50 V to 2500 V** and PI, DAR calculation;
- Varistor test 2,5 kV;
- Current measurements with clamps AC;
- TRMS voltage and frequency measurements;
- Low Ohm measurements with 7 mA and 200 mA DC test current;

### KEY FEATURES

- Possibility of performing all main types of earth measurements with a single instrument.
- Multi frequency test signal for best noise immunity.
- Insulation range: wide range of insulation test voltages from 50 V to 2500 V, resistance measuring range up to 100 G $\Omega$ .
- Overvoltage category 600 V CAT II, 300 V CAT III; **at 4000 m above sea level**.
- 4.3" colour LCD display with touch screen.
- Programmable AUTO SEQUENCES.
- High degree of protection: IP 54.
- **4-wire 200 mA DC** resistance measurement.
- Support for single or automated measurements.
- Built-in charger and rechargeable Li-Ion batteries as standard accessory.
- **BT communication** with PC, Android tablets and smart phones via built-in BT.
- PC SW Metrel ES Manager for measurement pre and post processing: preparation of the test structure, result download, tree-view, table view and graphical view, storing and printing.

### APPLICATION

- Initial and periodic testing of domestic and industrial installations;
- Industrial areas, smaller buildings, installation in mining.

### STANDARDS

#### Safety

- EN 61010 - 1
- EN 61010 - 2 - 030 c
- EN 61010 - 2 - 032
- EN 61010 - 031

#### Functionality

- EN 61557 - 2
- EN 61557 - 4
- EN 61557 - 5

#### Electromagnetic compatibility

- EN 61326

#### Other reference standards

- IEC/EN/HD 60364
- AS/NZ 3018
- CEI 64.8
- HD 384
- BS 7671
- VDE 0413

## TECHNICAL DATA

FUNCTION	Measuring range	Resolution	Accuracy	
Insulation resistance Riso Un = 2,5 kV	0 kΩ ... 999 kΩ	1 kΩ	±(3 % of reading + 3 digits)	
	1.00 MΩ ... 9.99 MΩ	0.01 MΩ		
	10.0 MΩ ... 99.9 MΩ	0.1 MΩ		
	100 MΩ ... 999 MΩ	1 MΩ		
	1.00 GΩ ... 9.99 GΩ	10 MΩ		
Continuity 200 mA of PE conductor with polarity change	0.020 Ω ... 1.999 Ω	0.001 Ω	±(1 % of reading + 2 digits)	
	2.00 Ω ... 19.99 Ω	0.01 Ω		
	20.0 Ω ... 999.9 Ω	0.1 Ω		
	1.000 kΩ ... 1.999 kΩ	1 Ω		
	0.0 Ω ... 199.9 Ω	0.1 Ω		±(0,5 % of reading + 5 digits)
200 Ω ... 1.999 kΩ	1 Ω			
2.00 kΩ ... 19.99 kΩ	10 Ω			
20.0 kΩ ... 199.9 kΩ	100 Ω			
200 kΩ ... 999 kΩ	1 kΩ			
Earth resistance 2/3/4-wire method Test frequency 55 - 164 Hz	0.010 Ω ... 1.999 Ω	0.001 Ω	±(3 % of reading + 3 digits)	
	2.00 Ω ... 19.99 Ω	0.01 Ω		
	20.0 Ω ... 199.9 Ω	0.1 Ω		
	200 Ω ... 999 Ω	1 Ω		
	1.000 kΩ ... 1.999 kΩ	0.001 kΩ		
Earth resistance 4-wire method with one current clamp - Selective	0.010 Ω ... 1.999 Ω	0.001 Ω	±(8 % of reading + 3 digits)	
	2.00 Ω ... 19.99 Ω	0.01 Ω		
	20.0 Ω ... 199.9 Ω	0.1 Ω		
	200 Ω ... 999 Ω	1 Ω		
	1.000 kΩ ... 1.999 kΩ	0.001 kΩ		
2-clamp earth resistance measurement	2.00 Ω ... 9.99 Ω	0.01 Ω	±(5 % of reading + 2 digits)	
	10.0 Ω ... 49.9 Ω	0.1 Ω		
	50 Ω ... 100 Ω	1 Ω		
	0.00 Ωm ... 19.99 Ωm	0.01 Ωm		calculated value (consider uncertainty of 4 - pole measurement)
	20.0 Ωm ... 199.9 Ωm	0.1 Ωm		
200 Ωm ... 999 Ωm	1 Ωm			
1.000 kΩm ... 1.999 kΩm	0.001 kΩm			
2.00 kΩm ... 19.99 kΩm	0.01 kΩm			
Earth Potential - voltage	0.00 mV ... 99.99 mV	0.01 mV	±(1 % of reading + 3 digits)	
	100.0 mV ... 999.9 mV	0.1 mV		
	1.000 V ... 9.999 V	1 mV		
	10.00 V ... 49.99 V	10 mV		
	0.1 V ... 199.9 V	0.1 V		calculated value
200 V ... 999 V	1 V			
Voltage TRMS	0.000 V ... 9.999 V	0.001 V	Range: 15 ... 99 Hz ±(0.5 % of reading + 3 digits)	
	10.00 V ... 99.99 V	0.01 V		
	100.0 V ... 749.9 V	0.1 V		
Voltage DC	0.000 V ... 9.999 V	0.001 V	Range: 400 ... 1200 Hz ±(5 % of reading + 3 digits)	
	10.00 V ... 99.99 V	0.01 V		
	100.0 V ... 999.9 V	0.1 V		
Frequency	15.00 Hz ... 99.99 Hz	0.01 Hz	±(0.2 % of reading + 1 digits)	
	100.0 Hz ... 999.9 Hz	0.1 Hz		
	1000 Hz ... 1200 Hz	1 Hz		
	10 mA ... 749 mA	1 mA		±(2.5 % of reading + 3 digits)
0.10 A ... 7.49 A	0.01 A			
2.0 A ... 99.9 A	0.1 A			
100 A ... 149 A	1 A			
20 A ... 999 A	1 A			
Varistor Test	0.0 V ... 99.9 V	0.1 V	±(1 % of reading + 3 digits)	
	100 V ... 999 V	1 V		
	1.00 kV ... 2.50 kV	10 V		
Measuring category	300 V CAT IV; derate to 600 V CAT II; 300 V CAT III at 4000 m ASL			
Protection class	Double insulation			
COM port	BT, USB			
Display	4.3" colour LCD display with backlight and touch screen			
Degree of protection	IP 54			
Power supply	7.2 V (4400 mAh Li-Ion battery pack)			
Dimensions	250 x 110 x 160 mm			
Weight	1.6 kg			

### STANDARD SET

#### MI 3288

- Instrument Earth-Insulation Tester
- Battery pack 7,2V 4400mAh
- Power supply adapter 12V/3A
- 2,5 kV Test lead, 2 x 1,5 m
- Test lead, green, 1,5 m
- Test probe, 2pcs (red, black)
- Crocodile clip 4 pcs (black, blue, green, red)
- Soft carrying bag
- USB cable
- PC SW Metrel ES Manager BASIC Licence
- Short Instruction manual

- Instruction manual (on CD)
- Calibration certificate

#### MI 3288 - 20 m

- MI 3288 ST
- Earth test set, 20 m (test lead, 4 x 1 m; 2 x test lead, 20 m; 2 x test lead, 4,5 m; 4 x earth test rod)

#### MI 3288 - 50 m

- MI 3288 ST
- Earth test set, 50 m (test lead, 4 x 1 m; 2 x test lead, 50 m; 2 x test lead, 4,5 m; 4 x earth test rod)



Picture of MI 3288 - 50 m set

# Earth testers

## MI 3295 Step Contact Voltage Measuring System



The MI 3295 Step Contact Voltage Measuring System is a voltage measuring system intended for testing and verification of protective earthing of power stations, substation and other power systems. The system consists of Station for current generation and autonomous voltage Meter. Due to high test current (up to 55 A) and effective noise cancellation the MI 3295 ensures very accurate and stable measurements of Step and Contact Voltages with the resolution down to 10  $\mu$ V. A few voltmeters can be used simultaneously for faster analysis of voltage distribution around the tested object. All test results and parameters can be saved into the instrument's memory for further downloading, analysis and test report printing with the help of the PC SW Metrel ES Manager or HVLink PRO.

High Voltage Insulation / Continuity / Earth / Transformer

### MEASURING FUNCTIONS

- Step voltage;
- Contact voltage;
- Specific earth resistance;
- Earth resistance;
- Potential;
- Leakage current.

### KEY FEATURES

- **Accurate:** high accuracy of the measurements due to a high current of up to 50 A and effective suppression of noise.
- **Noise immunity:** excellent immunity even against changing earth currents.
- **Autonomous Step Voltage meter:** no need for long potential leads; a few meters can be used simultaneously.
- **Safe:** high safety due to low output voltage (55 V).
- **Low weight:** the weight of the Station is 29.5 kg only.
- **Memory:** up to 1000 test results can be saved into the 3-level internal memory of the system.
- **PC SW Metrel ES Manager or HVLink PRO** included in the standard set enables downloading and analysis of results and printing of test reports.

### APPLICATION

#### Measurement of protective earthing of:

- Power stations;
- Substations;
- Distribution towers;
- Other power systems.

### STANDARDS

#### Functionality

- ANSI/IEEE Std 81;
- EN 61557-5;
- RAT 2008;
- HD 673 N4

#### Electromagnetic compatibility

- EN 61326

#### Safety

- EN 61010-1;
- EN 61010-031



## TECHNICAL DATA

FUNCTION	Measuring range	Resolution	Accuracy
Step voltage, Contact voltage (measuring range $U_m$ )	0.01 ... 19.99 mV	0.01 mV	$\pm(2\% \text{ of reading} + 2 \text{ digits})$
	20.0 ... 199.9 mV	0.1 mV	$\pm(2\% \text{ of reading} + 2 \text{ digits})$
	200 ... 1999 mV	1 mV	$\pm(2\% \text{ of reading} + 2 \text{ digits})$
	2.00 ... 19.99 V	0.01 V	$\pm(2\% \text{ of reading} + 2 \text{ digits})$
	20.0 V ... 59.9 V	0.1 V	$\pm(2\% \text{ of reading} + 2 \text{ digits})$
Step voltage, Contact voltage (calculated measuring range U)	0.0 ... 199.9 V	0.1 V	calculated value*
	200 ... 999 V	1 V	
Potential (MI 3295M)	0.01 ... 19.99 mV	0.01 mV	$\pm(2\% \text{ of reading} + 2 \text{ dig})$
	20.0 ... 199.9 mV	0.1 mV	
	200 ... 1999 mV	1 mV	
	2.00 ... 19.99 V	0.01 V	
	20.0 ... 59.9 V	0.1 V	
Test current	55 A max		
Test voltage	< 55 V		
Test frequency	55 Hz		
Current	0.00 ... 9.99 A	0.01 A	$\pm(3\% \text{ of reading} + 5 \text{ digits})$
	10.0 ... 99.9 A	0.1 A	$\pm(3\% \text{ of reading} + 3 \text{ digits})$
Resistance to earth	0.001 ... 1.999 $\Omega$	0.001 $\Omega$	$\pm(2\% \text{ of reading} + 5 \text{ digits})$
	2.00 ... 19.99 $\Omega$	0.01 $\Omega$	$\pm(2\% \text{ of reading} + 5 \text{ digits})$
	20.0 ... 99.9 $\Omega$	0.1 $\Omega$	$\pm(2\% \text{ of reading} + 5 \text{ digits})$
	100.0 ... 199.9 $\Omega$	0.1 $\Omega$	$\pm 5\% \text{ of reading}$
Specific earth resistance	0.00 ... 9.99 $\Omega m$	0.01 $\Omega m$	Calculated value, consider accuracy of Resistance to earth function.
	10.0 ... 99.9 $\Omega m$	0.1 $\Omega m$	
	100 ... 999 $\Omega m$	1 $\Omega m$	
	1.00 k ... 9.99 k $\Omega m$	10 $\Omega m$	
	10.0 k ... 99.9 k $\Omega m$	100 $\Omega m$	
Open circuit voltage	< 50 VAC		
Test current	< 7.5 A		
Test frequency	55 Hz		
Current (MI 3295M)	1.0 ... 99.9 mA	0.1 mA	$\pm(2\% \text{ of reading} + 3 \text{ dig})$
	100 ... 999 mA	1 mA	
Iron clamp A 1018	1.00 ... 9.99 A	0.01 A	
	10.0 ... 99.9 A	0.1 mA	$\pm(8\% \text{ of reading} + 5 \text{ dig})$
Current (MI 3295M)	100 ... 999 mA	1 mA	
	1.00 ... 9.99 A	0.01 A	
Flex clamp A 1587	10.0 ... 30.0 A	0.1 A	
	10.0 ... 50.0 A	0.1 A	
<b>STATION</b>			
Power supply	230 V / 50 or 60 Hz		
Communication port	RS232		
Memory	1000 memory locations		
Overvoltage category	CAT II / 300 V		
Measuring category	CAT IV / 50 V		
Protection degree	IP 30		
Display	LCD with backlight (128 x 64 dots)		
Dimensions	563 x 275 x 257 mm		
Weight	29.5 kg		
<b>METER</b>			
Power supply	6 x 1.2 V rechargeable batteries, type AA		
Communication ports	USB, RS232		
Memory	1500 memory locations		
Measuring category	CAT IV / 50 V		
Protection degree	IP 40		
Display	LCD with backlight (128 x 64 dots)		
Dimensions	230 x 103 x 115 mm		
Weight	1.3 kg		

\*Displayed Step / Contact voltage is obtained on base of calculation:

$$U_S = U_{\text{meas}} \cdot I_{\text{fault}} / I_{\text{gen}}; U_C = U_{\text{meas}} \cdot I_{\text{fault}} / I_{\text{gen}};$$

$I_{\text{fault}}$  (selectable): 1 A ... 200 kA

### STANDARD SET

#### MI 3295

- Instruments MI 3295M and MI 3295S
- Mains cable
- Step voltage probe (25 kg), 2 pcs: A 1353
- Current earth spike A 1529, 2 pcs
- Potential earth spike, 60 cm A 1629, 2 pcs
- Current test lead, 50 m, black, 10 mm<sup>2</sup>, with crocodile clip, on reel, A 1325
- Current test lead, 10 m, black, 10 mm<sup>2</sup>, with crocodile clip, A 1392
- G clamp A 1530
- Test lead, black, 2 x 3 m
- Test lead, green, 10 m

- Test lead, black, 1.5 m
- Test lead, green, 4 m
- Test lead, red, 50 m
- Connection lead with crocodile clip, red, 1 m
- Crocodile clip, 2 pcs
- RS232 cable
- USB cable
- Soft carrying bag, 2 pcs
- Soft carrying neck belt
- NiMH battery cells, type AA, 6 pcs
- Power supply adapter
- CD with instruction manual and PC SW Metrel ES Manager and HVLink PRO
- Instruction manual
- Calibration certificate



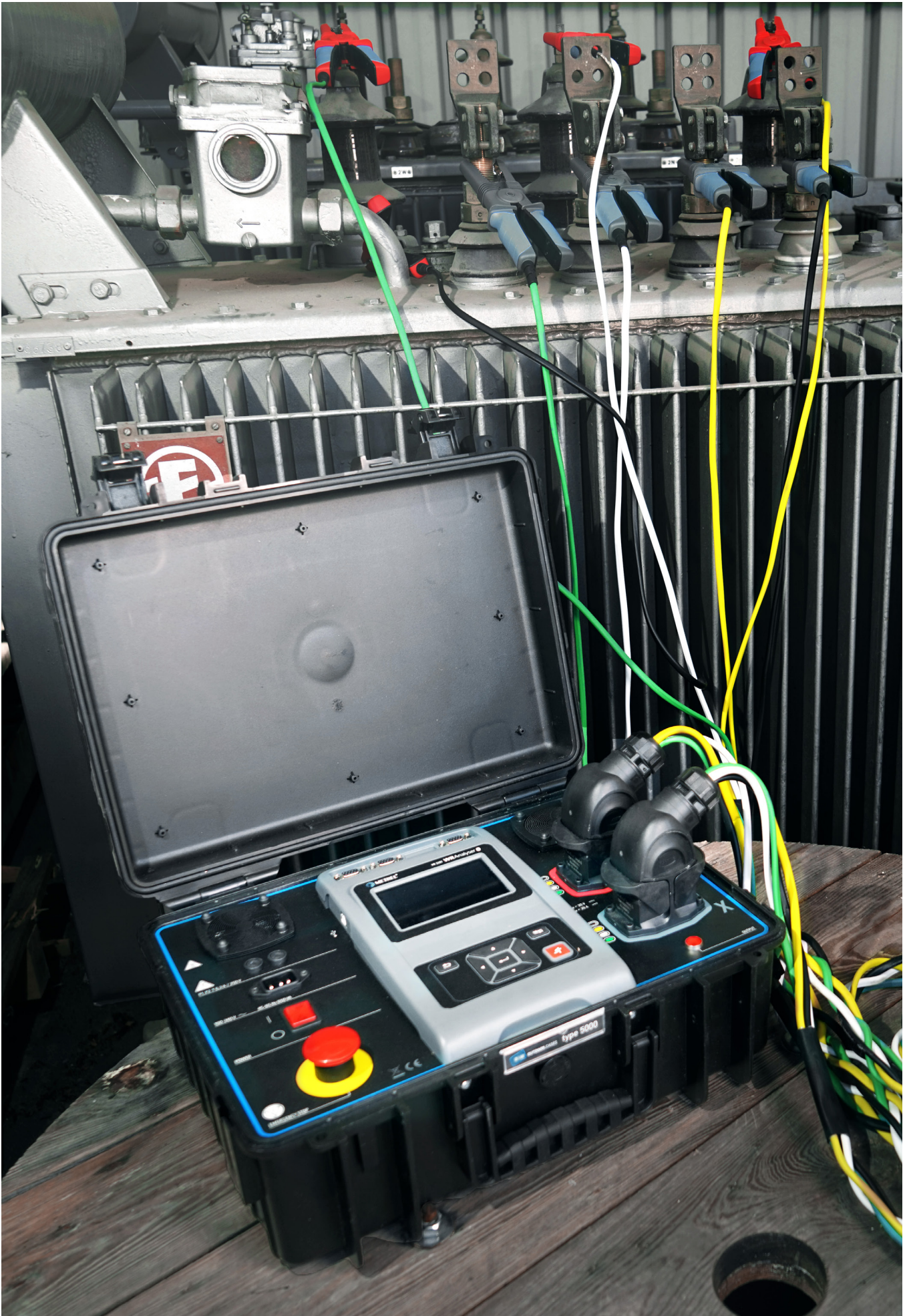

Picture of MI 3295 set



# Transformer testers

## Selection Guide for Transformer testers

FEATURES	Description	MI 3281 WR Analyser <b>NEW</b>	MI 3280 Digital Transformer Analyser
			
<b>WINDING RESISTANCE</b>	single phase/three phase	•	•
	Maximum test current	20 A	1 A
	WR range	1 $\mu\Omega$ ... 9,999 k $\Omega$	1 m $\Omega$ ... 999,9 $\Omega$
	resolution	0.1 $\mu\Omega$ ... 1 $\Omega$	0.1 m $\Omega$ ... 0.1 $\Omega$
	Basic Accuracy	0,25%	2%
	Open terminal test voltage	< 30 V DC	< 17 V
	Demagnetisation	•	
<b>TURN RATIO</b>	TTR range		0.8 ... 8000
	Basic Accuracy		0.20%
	Open terminal test voltage		1/5/10/40/80 V
	Test frequency		55/65/70 Hz
<b>OTHER FEATURES</b>	Tap changer control	•	
	Automatic test with tap changer	•	
	Temperature conversion	•	
	PC SW	•	•
	Test report generation	Optional	Optional
<b>GENERAL DATA</b>	Colour touch screen	Colour TFT display with touch screen, 4.3 inch, 480 x 272 pixels	Colour TFT display with touch screen, 4.3 inch, 480 x 272 pixels
	Safety category	50 V / CAT IV	50 V / CAT IV
	IP protection	IP 65 (case closed), IP 40 (case open)	IP 65 (case closed), IP 54 (case open)
	Rechargeable batteries		14,4 V, 4,4 Ah Li-ion
	Built-in battery charger		•
	Memory	> 1 GB	> 1 GB
	Mains voltage	100 ... 240 V <sub>ac</sub> , 45 ... 65 Hz, 650 VA (300 V /CAT II)	90 ... 260 V <sub>ac</sub> , 45 ... 65 Hz, 100 VA (300 V / CAT II)
	Weight	9,3 kg, (without accessories)	6,3 kg, (without accessories)
Dimensions	470 x 190 x 370 mm	360 x 160 x 330 mm	

# Transformer testers

## MI 3281 WR Analyser

NEW

High Voltage Insulation / Continuity / Earth / Transformer



The MI 3281 Winding Resistance Analyser (WR Analyser) is a portable test instrument intended for diagnosing of winding resistance of single and three phase transformers with manual or automatic tap changer test and demagnetization of tested transformer. Selectable test current in range from 10mA to 20A. The operation is straightforward and clear to enable the user to operate the instrument without the need for special training. For advanced users the AUTO SEQUENCES and visual tests are available.

### MEASURING FUNCTIONS

Available functions and features offered by the WR Analyser:

- Winding resistance measurement of single and three phase transformers;
- Winding resistance measurement of single and three phase transformers with manual or automatic tap changer test (automatic measurement of all windings);
- Demagnetization of single and three phase transformers.

### KEY FEATURES

- A 4.3" color LCD display with touch screen offers easy-to-read results and all associated parameters.
- The operation is straightforward and clear to enable the user to operate the instrument without the need for special training.
- Test results can be stored on the instrument.

- PC software that is supplied as a part of standard set enables transfer of measured results to PC where they can be analyzed or printed.
- Creation and printing of reports (optional)
- Built-in help screens for referencing on site.
- Autotest sequences.
- BT communication with PC, Android tablets and smart phones via built-in BT.
- EMERGENCY STOP switch in case of any emergency situation.
- Automatic or manual tap changer test
- Winding resistances conversion to a desired reference temperature.
- Selectable test current up to 20 A.
- Automatic discharge after finished measurement.
- PC SW Metrel ES Manager for creation of test structures and uploading, downloading of test results, autotest editor and report creation.
- Degree of protection IP 65 (case closed), IP 40 (case open).

### APPLICATION

- Three phase and single phase power transformers.
- Voltage transformers.
- Current transformers.

### STANDARDS

#### Functionality

- C57.12.70
- C57.12.90

#### Electromagnetic compatibility

- EN 61326-1

#### Safety

- EN 61010 - 1
- EN 61010 - 2 - 030
- EN 61010 - 031

## TECHNICAL DATA

Function	Measuring range	Resolution	Accuracy	
<b>Winding resistance</b> <b>R<sub>H</sub>, R<sub>X</sub>,</b> <b>R<sub>10</sub>, R<sub>20</sub>, R<sub>30</sub>,</b> <b>R<sub>12</sub>, R<sub>23</sub>, R<sub>31</sub></b>	20 A, 15 A, 10 A	10.0 $\mu\Omega$ ... 1999.9 $\mu\Omega$ 2.000 m $\Omega$ ... 19.999 m $\Omega$ 20.00 m $\Omega$ ... 199.99 m $\Omega$ 200.0 m $\Omega$ ... 1999.9 m $\Omega$	0.1 $\mu\Omega$ 1 $\mu\Omega$ 10 $\mu\Omega$ 100 $\mu\Omega$	$\pm 0.25\%$ of reading $\pm 0.1\%$ Range
	5 A, 1 A	0.100 m $\Omega$ ... 19.999 m $\Omega$ 20.00 m $\Omega$ ... 199.99 m $\Omega$ 200.0 m $\Omega$ ... 1999.9 m $\Omega$ 2.000 $\Omega$ ... 19.999 $\Omega$	1 $\mu\Omega$ 10 $\mu\Omega$ 100 $\mu\Omega$ 1 m $\Omega$	$\pm 0.25\%$ of reading $\pm 0.1\%$ Range
	100 mA	1.00 m $\Omega$ ... 199.99 m $\Omega$ 200.0 m $\Omega$ ... 1999.9 m $\Omega$ 2.000 $\Omega$ ... 19.999 $\Omega$ 20.00 $\Omega$ ... 199.99 $\Omega$	10 $\mu\Omega$ 100 $\mu\Omega$ 1 m $\Omega$ 10 m $\Omega$	$\pm 0.25\%$ of reading $\pm 0.1\%$ Range
	10 mA	10.0 m $\Omega$ ... 1999.9 m $\Omega$ 2.000 $\Omega$ ... 19.999 $\Omega$ 20.00 $\Omega$ ... 199.99 $\Omega$ 200.0 $\Omega$ ... 999.9 $\Omega$ 1.000 k $\Omega$ ... 9.999 k $\Omega$	100 $\mu\Omega$ 1 m $\Omega$ 10 m $\Omega$ 100 m $\Omega$ 1 $\Omega$	$\pm 0.25\%$ of reading $\pm 0.1\%$ Range   $\pm 2\%$ of reading $\pm 2\%$ Range
	<b>GENERAL</b>	Test current accuracy		$\pm 15\%$
		Open terminal test voltage		<30 VDC
		Max. short-circuit test current		20 A
		Automatic discharge		Yes
		Mains power supply		100 VAC ... 240 VAC, 45 Hz ... 65 HZ, 650 VA
		Over-voltage category		300 V / CAT II
		Pollution degree		2
		Degree of protection		IP 65 (closed), IP 40 (open)
Dimensions			470 x 190 x 370 mm	
Weight			9.3 kg, (without accessories)	
Display			4.3" (10.9 cm) 480 x 272 pixels TFT color display	
Memory		> 1 GB		

## STANDARD SET

### MI 3281 5M set

- MI 3281 Instrument
- A 1715 5M H-side test cable
- A 1716 5M X-side test cable
- A 1757 Large Kelvin test clip with jaw opening 65 mm
- A 1813 Tap changer control cable 10 m USB cable
- Mains cable
- A 1552 Bag for accessories
- Metrel ES Manager BASIC license\*
- Instruction manual
- Calibration certificate

### MI 3281 10M set

- MI 3281 Instrument
- A 1715 10M H-side test cable
- A 1716 10M X-side test cable
- A 1777 2 x Transportation reel for cables
- A 1757 Large Kelvin test clip with jaw opening 65 mm
- A 1814 2 x Fastening rope 1 m with carabiner hook
- A 1813 Tap changer control cable 10 m USB cable
- Mains cable
- A 1006 Bag for accessories
- Metrel ES Manager BASIC license\*
- Instruction manual
- Calibration certificate

### MI 3281 15M set

- MI 3281 Instrument
- A 1715 15M H-side test cable
- A 1716 15M X-side test cable
- A 1777 2 x Transportation reel for cables
- A 1757 Large Kelvin test clip with jaw opening 65 mm
- A 1814 2 x Fastening rope 1 m with carabiner hook
- A 1813 Tap changer control cable 10 m USB cable
- Mains cable
- A 1006 Bag for accessories
- Metrel ES Manager BASIC license\*
- Instruction manual
- Calibration certificate



Picture of MI 3281 5M set



Picture of MI 3281 10M set



Picture of MI 3281 15M set

\* The BASIC license can be any time upgraded to PRO license with ordering the PRO license key P 1101

# Transformer testers

## MI 3280 Digital Transformer Analyser



The MI 3280 Digital Transformer Analyser is a portable, battery (Li-ion) powered test instrument intended for diagnosing of turn ratio, phase deviation, excitation current and winding resistance of single and three phase transformers. It has an excellent IP protection: IP65 (case closed), IP54 (case open) allowing the use of the instrument in harsh environments. The operation is straightforward and clear to enable the user to operate the instrument without the need for special training. For advanced users the AUTO SEQUENCES and visual tests are available.

### MEASURING FUNCTIONS

Available functions and features offered by the Digital Transformer Analyser:

- Turn ratio measurement of single and three phase transformers;
- Phase deviation between high voltage and low voltage winding;
- Excitation current;
- Winding resistance measurement of single and three phase transformers (Power Transformers up to 1,6 MVA).

### KEY FEATURES

- High resolution colour touch screen, 4.3" TFT.
- The operation is straightforward and clear to enable the user to operate the instrument without the need for special training.
- Test results can be stored on the

instrument. PC software that is supplied as a part of standard set enables transfer of measured results to PC where they can be analysed or printed.

- Built-in help screens for referencing on site.
- Autotest sequences.
- Built-in charger and rechargeable batteries as standard accessory.
- BT communication with PC, Android tablets and smart phones via built-in BT.
- PC SW Metrel ES Manager for creation of test structures and uploading, downloading of test results, autotest editor and report creation.
- High degree of protection IP 65 (case closed), IP 54 (case open).

### APPLICATION

- Three phase and single phase power transformers.
- Voltage transformers.
- Current transformers.

### STANDARDS

#### Functionality

- C57.12.70
- IEC 60076-1

#### Electromagnetic compatibility

- EN 61326

#### Safety

- EN 61010 - 1
- EN 61010 - 2 - 030
- EN 61010 - 2 - 033
- EN 61010 - 031

#### Li - ion battery pack

- IEC 62133

## TECHNICAL DATA

Function		Measuring range	Resolution	Accuracy
<b>TURN RATIO</b> <b>r, rA, rB, rC</b>	Excitation voltage 80 V	0.8000 ... 9.9999	0.0001	±(0.2% of reading + 2 digits)
		10.000 ... 99.999	0.001	±(0.2% of reading + 2 digits)
		100.00 ... 999.99	0.01	±(0.2% of reading + 2 digits)
		1000.0 ... 1999.9	0.1	±(0.5% of reading + 2 digits)
		2000.0 ... 3999.9	0.1	±(0.5% of reading + 2 digits)
	Excitation voltage 40 V	4000.0 ... 8000.0	0.1	±(1.0% of reading + 2 digits)
		0.8000 ... 9.9999	0.0001	±(0.2% of reading + 2 digits)
		10.000 ... 99.999	0.001	±(0.2% of reading + 2 digits)
		100.00 ... 999.99	0.01	±(0.2% of reading + 2 digits)
		1000.0 ... 1999.9	0.01	±(0.5% of reading + 2 digits)
	Excitation voltage 10 V	2000.0 ... 3999.9	0.1	±(0.5% of reading + 2 digits)
		4000.0 ... 8000.0	0.1	n/a
		0.8000 ... 9.9999	0.0001	±(0.2% of reading + 2 digits)
		10.000 ... 99.999	0.001	±(0.2% of reading + 2 digits)
		100.00 ... 999.99	0.01	±(0.5% of reading + 2 digits)
	Excitation voltage 5 V	1000.0 ... 8000.0	0.1	n/a
		0.8000 ... 9.9999	0.0001	±(0.2% of reading + 2 digits)
		10.000 ... 99.999	0.001	±(0.2% of reading + 2 digits)
		100.00 ... 999.99	0.01	±(0.5% of reading + 2 digits)
		1000.0 ... 8000.0	0.1	n/a
Excitation voltage 1 V	0.8000 ... 9.9999	0.0001	±(0.2% of reading + 2 digits)	
	10.000 ... 99.999	0.001	±(0.5% of reading + 2 digits)	
	100.00 ... 999.99	0.01	n/a	
	1000.0 ... 8000.0	0.1	n/a	
	0.10 mA ... 9.99 mA	0.01 mA	±(2 % of reading + 0.20 mA)	
<b>EXCITATION CURRENT</b> <b>i, iA, iB, iC</b>	Test frequency 55, 65 or 70 Hz	10.0 mA ... 99.9 mA	0.1 mA	±(2 % of reading + 2 digits)
		100 mA ... 999 mA	1 mA	±(2 % of reading + 2 digits)
		1.00 A ... 1.10 A	0.01 A	±(2 % of reading + 2 digits)
		0.10 mA ... 9.99 mA	0.01 mA	±(2 % of reading + 0.20 mA)
<b>PHASE DEVIATION</b> <b>ϕI, ϕA, ϕB, ϕC</b>	Test frequency 55, 65 or 70 Hz	-180.00 ... 180.00 °	0.01°	±(0.05°)
		1.0 mΩ ... 999.0 mΩ	0.1 mΩ	±(2 % of reading + 3 digits)
<b>WINDING RESISTANCE</b> <b>R, RA, RB, RC</b>	Test current 10 mA ... 1000 mA	1.000 Ω ... 9.999 Ω	0.001 Ω	±(2 % of reading + 2 digits)
		10.00 Ω ... 99.99 Ω	0.01 Ω	±(2 % of reading + 2 digits)
		100.0 Ω ... 999.9 Ω	0.1 Ω	±(2 % of reading + 2 digits)
		100.0 Ω ... 999.9 Ω	0.1 Ω	±(2 % of reading + 2 digits)
<b>GENERAL</b>	Battery power supply	14.4 V DC (4.4Ah Li-ion)		
	Battery charging time	typical 4.5 h (deep discharge)		
	Mains power supply	90-260 VAC, 45-65 Hz, 100 VA (300 V CAT II)		
	Protection classification	reinforced insulation		
	Measuring category	50 V CAT IV		
	Pollution degree	2		
	Degree of protection	IP 65 (case closed), IP 54 (case open)		
	Display	Colour TFT display, 4.3 inch, 480 x 272 pixels		
	Dimensions	360 x 160 x 330 mm		
	Weight	8.8 kg, (with battery and accessories)		

### STANDARD SET

#### MI 3280

- Instrument MI 3280
- 4 wire test lead with banana, 4 pcs
- Large Kelvin test crocodile, 8 pcs
- USB cable

- Mains cable
- Soft carrying bag
- Metrel ES Manager BASIC Licence\*
- Instruction manual
- Calibration certificate

\*Metrel ES Manager can be downloaded free of charge from Metrel Web server.



Picture of MI 3280 set





# Continuity testers

## Selection Guide for Continuity Insulation Testers

FEATURES	Description	MI 3252 MicroOhm 100A	MI 3250 MicroOhm 10A	MI 3242 MicroOhm 2A
				
<b>MEASUREMENTS</b>	Measuring range	1 nΩ ... 20 Ω	100 nΩ ... 2 kΩ	1 μΩ ... 200 Ω
	No. of ranges	6	7	6
	Current into load	2 mΩ at 100 A	200 mΩ at 10 A	1 Ω at 2 A
	Highest resolution	1 nΩ	0.1 μΩ	1 μΩ
	Basic accuracy	0.25 %	0.25 %	0.25 %
	Test current	100 A, 50 A, 10 A, 1 A, 100 mA	10 A, 1 A, 100 mA, 10 mA, 1 mA	2 A, 100 mA, 10 mA
<b>OTHER FEATURES</b>	Measurement modes	Single, Continuous	Single, Automatic, Inductive, Continuous	Single, Automatic, Inductive, Continuous
	Test method	4-wire, unidirectional	4-wire, Bidirectional	4-wire, Bidirectional
	Auto ranging		•	•
	PASS / FAIL indication	•	•	•
	Temperature compensation		•	
<b>COMMUNICATION PORTS</b>	RS232	•	•	•
	USB	•	•	•
<b>MEMORY, SOFTWARE</b>	Memory	•	•	•
	Number of memory locations	1000 / 2 levels	1000	1500
	Software	HVLink PRO	HVLink PRO	HVLink PRO
<b>GENERAL DATA</b>	Display type	Graphical LCD	Graphical LCD	Graphical LCD
	Backlight	•	•	•
	Safety category	CAT IV / 50 V CAT II / 300 V	CAT IV / 300 V CAT II / 300 V	CAT IV / 300 V CAT III / 600 V
	Rechargeable batteries	•	•	•
	Battery	12 V / 12 Ah	6 x NiMH, type HR14	6 x NiMH, type AA
	Built-in battery charger		•	•
	Low battery indication	•	•	•
	Mains voltage	115 / 230 V AC, 50 / 60 Hz, 200 VA	90-260 V AC, 45-65 Hz, 50 W	
	Weight	11.8 kg	2.8 kg	0.8 kg
	Dimensions (mm)	410 x 175 x 370	310 x 130 x 250	140 x 80 x 230

# Continuity testers

## MI 3252 MicroOhm 100A



The MI 3252 MicroOhm 100A is portable low resistance ohmmeter used to measure low contact resistances of circuit breakers, switches and busbar joints using test current from 100 mA to 100 A. Used 4-lead Kelvin testing method ensures very high accuracy of results (0.25%) due to elimination of test leads resistance. The instrument can be powered from both mains supply and internal battery. PC SW HVLink PRO supplied as a standard accessory enables downloading, analysis and export of test results and printing of test reports.

### MEASURING FUNCTIONS

- Resistance measurement with adjustable test current (100 mA ... 100 A);
- Voltage drop measurement.

### KEY FEATURES

- **Accurate:** 1 n $\Omega$  best resolution with 0.25% accuracy.
- **Bar graph:** on screen resistance bar graph.
- **Battery powered:** the instrument enables measurements with 100 A for up to 10 minutes when powered from internal battery only.
- **Safe:** sustain external voltages in case of wrong connection, protection level (CAT IV / 50 V); automatically detects continuity in current circuit.
- **Single and continuous** measuring modes.
- **Custom limits:** the limits can be set for PASS or FAIL evaluation of test result.
- **Portable:** rugged carrying case with a handle and lightweight design (less than 12 kg) enable easy moving the instrument between sites.
- **High protection degree:** IP 64.
- **Memory:** built-in memory enables storage of up to 1000 test results.
- **Downloadable:** downloads test results via RS232 or USB cable directly to the PC with the help of the HVLink PRO software.

### APPLICATION

#### Measurement the resistance of:

- High, middle and low voltage circuit breakers;
- High, middle and low voltage disconnecting switches;
- High current busbar joints;
- Cable splices;
- Welding joints.

### STANDARDS

#### Functionality

- IEC 62271-100;
- IEC 62271-1;
- ANSI C37.09;
- ASTM B 539;
- NMEA AB 4-1996;
- El Real Decreto 223/2008

#### Electromagnetic compatibility

- IEC 61326-1 Class B

#### Safety

- EN 61010-1;

## TECHNICAL DATA

FUNCTION	Measuring range	Resolution	Accuracy	Current	
Resistance	10.000 ... 199.999 $\mu\Omega$	1 n $\Omega$	$\pm 0.25$ % of reading	100 A	
	0.20000 ... 1.99999 m $\Omega$	10 n $\Omega$		100 A / 50 A	
	2.0000 ... 19.9999 m $\Omega$	100 n $\Omega$		50 A / 10 A	
	20.000 ... 199.999 m $\Omega$	1 $\mu\Omega$		1 / 10 A	
	0.20000 ... 1.99999 $\Omega$	10 $\mu\Omega$		1 A / 100 mA	
	2.0000 ... 19.9999 $\Omega$	100 $\mu\Omega$		100 mA	
FUNCTION	Measuring range	Resolution	Accuracy	Current	
Voltage	200 $\mu\Omega$	1.000 mV ... 20.000 mV	1 $\mu\text{V}$	$\pm 0.25$ % of reading	100 A
	2 m $\Omega$	20.00 mV ... 200.00 mV	10 $\mu\text{V}$		100 A
	20 m $\Omega$	10.00 mV ... 100.00 mV	10 $\mu\text{V}$		50 A
		100.0 mV ... 1.0000 V	0.1 mV		50 A
	200 m $\Omega$	20.0 mV ... 200.0 mV	0.1 mV		10 A
		200.0 mV ... 2.0000 V	0.1 mV		1 A
	2 $\Omega$	20.0 mV ... 200.0 mV	0.1 mV		10 A
		200.0 mV ... 2.0000 V	0.1 mV		1 A
	20 $\Omega$	20.0 mV ... 200.0 mV	0.1 mV		100 mA
		200.0 mV ... 2.0000 V	0.1 mV		100 mA
Power supply	230 / 115 VAC				
Battery	12 VDC / 12 Ah				
Overvoltage category	CAT IV / 50 V				
Display	320 x 240 LCD with backlight				
Communications	RS 232 and USB				
Memory	512 kB (1000 test results)				
Dimensions	410 x 175 x 370 mm				
Weight	11.8 kg				

### STANDARD SET

#### MI 3252

- Instrument MicroOhm 100A
- Current test lead with crocodile clip, 5 m, 25 mm<sup>2</sup>, 2 pcs
- Potential test lead, 5 m, 2 pcs (red, black)
- Test probe, 2 pcs (red, black)
- Crocodile clip, 2 pcs (red, black)
- Mains cable
- RS232 cable
- USB cable

- Bag for accessories
- PC SW HVLINK PRO
- Instruction manual
- Calibration certificate



Picture of MI 3252 set

# Continuity testers

## MI 3250 MicroOhm 10A



The MI 3250 MicroOhm 10A is portable low resistance ohmmeter for measuring low resistances of breakers and switches, busbars, cable joints, small to medium sized transformer and motor windings for industrial application, etc., with test current up to 10 A. The used 4-lead Kelvin testing method together with automatic bidirectional procedure ensure very high accuracy of test results (0,25%). The instrument can be powered by mains or internal rechargeable batteries. Test results can be stored on the instrument and with PC software HVLink PRO that is supplied as a part of standard set enables transfer of measured results to PC where they can be analysed or printed.

### MEASURING FUNCTIONS

- Bidirectional resistance measurement from 0,1  $\mu\Omega$  up to 2000  $\Omega$  with test current up to 10 A;
- Temperature compensation (with optional temperature probe).

### KEY FEATURES

- **Accurate:** 0.1 n $\Omega$  best resolution with 0.25% accuracy.
- **Bar graph:** on screen resistance bar graph.
- **Battery powered:** more than 1000 measurements with 10 A test current can be performed when powered by internal battery only.
- **Safe:** High overvoltage category CAT IV / 300 V.

- **Four measuring modes:** Automatic, single, continuous and inductive.
- **Automatic thermal EMF elimination:** with automatic bidirectional measurement.
- **Temperature compensation:** measured resistance can be adjusted according to ambient temperature, which can be entered manually or measured by external probe.
- **Custom limits:** limits can be set for PASS/FAIL evaluation of test results.
- **Portable:** lightweight 3 kg design with carry handle and shoulder strap.
- **Memory:** built-in memory enables storage of up to 1000 test results.
- **Downloadable:** stored test results can be via RS232 or USB interface transferred to the PC with installed HVLink PRO software, which enables downloading, review, analyses and printing of the test results.

### APPLICATION

#### Measurement the resistance of:

- Bus bar joints;
- Motor and transformer windings;
- Cables;
- Fuses;
- Aircraft frame bonds;
- Rail and pipe bonds;
- Lightning conductor bonding.

### STANDARDS

#### Electromagnetic compatibility

- IEC 61326-1

#### Safety

- EN 61010-1;
- EN 61010-031;

## TECHNICAL DATA

FUNCTION	Measuring range	Resolution	Accuracy	Current
Resistance	1.9999 mΩ	0.1 μΩ	±(0.25 % of reading + 0.01 % FS)	10 A
	19.999 mΩ	1 μΩ	±(0.25 % of reading + 0.01 % FS)	10 A/1 A
	199.99 mΩ	10 μΩ	±(0.25 % of reading + 0.01 % FS)	10 A/1 A/100 mA
	1.9999 Ω	100 μΩ	±(0.25 % of reading + 0.01 % FS)	1 A/100 mA/10 mA
	19.999 Ω	1 mΩ	±(0.25 % of reading + 0.01 % FS)	100 mA/10 mA
	199.99 Ω	10 mΩ	±(1 % of reading + 0.1 % FS)	1 mA
	199.99 Ω	10 mΩ	±(0.25 % of reading + 0.01 % FS)	10 mA
	199.99 Ω	100 mΩ	±(1 % of reading + 0.25 % FS)	1 mA
	1.9999 kΩ	1 Ω	±(1 % of reading + 0.25 % FS)	1 mA
Power supply (mains voltage)	90 ... 260 VAC / 60 VA			
Power supply (batteries)	6 x 1.2 V NiMH 3500 mAh batteries, type C			
Operation	> 1000 single measurements			
Overvoltage category	CAT IV / 300 V			
Protection class	Double insulation			
Display	320 x 240 LCD with backlight			
Communication	RS232 and USB			
Memory	1000 memory locations			
Dimensions	310 x 130 x 250 mm			
Weight	2.8 kg			

### STANDARD SET

#### MI 3250

- Instrument MI 3250 MicroOhm 10A
- Large Kelvin test clip, 2 pcs
- Test cable with Kelvin Probe, 2 pcs
- Test cable, 2.5 m, 4 pcs (2 x black, 2 x red)
- Crocodile clip, 4 pcs (2 x black, 2 x red)
- Test probe, 2 pcs (black)
- Mains cable
- USB cable and RS232 cable
- NiMH rechargeable batteries, type C, 6 pcs

- PC SW HVLink PRO
- Bag for accessories
- Instruction manual
- Calibration certificate



Picture of MI 3250 set

# Continuity testers

## MI 3242 MicroOhm 2A

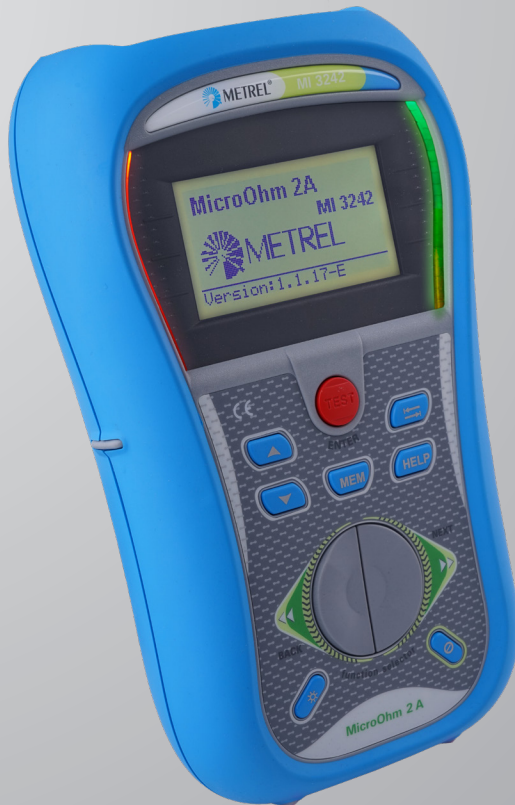

MI 3242 MicroOhm 2 A is a portable low resistance ohmmeter used to measure low resistances of switches, relays, connectors, bus bars, power distribution cable joints, motor & generator winding, power transformers, power inductors, rail track joints, wire and cable resistance, welding joints for industrial application, etc., with test current up to 2 A.

### MEASURING FUNCTIONS

- Bidirectional resistance measurement from  $1\ \mu\Omega$  up to  $199,9\ \Omega$  with test current up to 2 A.

### KEY FEATURES

- **Four measuring modes:** Automatic, single, continuous and inductive.
- **Automatic thermal EMF elimination:** with automatic bidirectional measurement.
- **Accurate:**  $1\ \mu\Omega$  best resolution with 0.25% accuracy.
- **Noise rejection:** 50 Hz / 60 Hz ripple detection and rejection.
- **Battery powered:** more than 800 measurements of  $500\ m\Omega$  load  $\infty 2$

A test current & 15 s measurement duration.

- **Safe:** High overvoltage protection (CAT III / 600 V) allows measurement in substations and other points with low line resistance. Internal protection circuit protects user and instrument from inadvertent connection to lines.
- **Custom limits:** Pre-programmed limits with PASS/FAIL evaluation of measurement result and bright REEN/RED indicators providing visual evaluation of the results.
- **Portable:** Lightweight portable design.
- **Memory:** Up to 1500 test results with timestamp can be stored in internal memory.
- **Downloadable:** PC SW HVLink PRO enables downloading, review, analyses and printing of test results.

### APPLICATION

#### Measurement the resistance of: In inductive mode:

- Motor & generator winding;
- Power transformer;
- Power inductors;
- Wire & cable resistance.

### STANDARDS

#### Electromagnetic compatibility

- EN 61326 Class A

#### Safety

- EN 61010-1;
- EN 61010-031

## TECHNICAL DATA

FUNCTION	Measuring range	Resolution	Accuracy	Current
Resistance	9.999 mΩ	1 μΩ	±(0.25 % of reading + 2 digits)	2 A
	99.99 mΩ	10 μΩ		
	999.9 mΩ	100 μΩ		
	99.99 mΩ	10 μΩ		
	999.9 mΩ	100 μΩ		
	9.999 Ω	1 mΩ		
	19.99 Ω	10 mΩ		
	999.9 mΩ	100 μΩ		
	9.999 Ω	1 mΩ		
	99.99 Ω	10 mΩ		
	199.9 Ω	100 mΩ		
Voltage	0 ... 49.9	0.1 V	±(2 % of reading + 2 digits)	
	50 ... 550	1 V		
Frequency	10.0 ... 99.9	0.1 Hz	±(0.2 % of reading + 1 digit)	
	100 ... 500	1 Hz		
Power supply (batteries)	9 VDC (6 x 1.5 V battery or accu, size AA)			
Operation	> 800 single measurements			
Overvoltage category	CAT III / 600 V; CAT IV / 300 V			
Protection class	Double insulation			
Display	128 x 64 dots matrix display with backlight			
Communication	RS232 and USB			
Memory	1500 memory locations			
Dimensions	140 x 80 x 230 mm			
Weight	0.8 kg			

### STANDARD SET

#### MI 3242

- Instrument MI 3242 MicroOhm 2A
- Test cable with Kelvin probe, 2 pcs
- Test cable 4 wire, 2.5 m
- Crocodile clip, 4 pcs (2x black, 2x red)
- Test probe, 2 pcs (black)
- Power supply adapter
- 1.2 V NiMH rechargeable battery, 6pcs
- RS232 serial cable
- USB cable

- Soft carrying bag
- PC SW HVLink PRO
- Instruction manual
- Calibration certificate



Picture of MI 3242 set

# High voltage insulation testers

## Selection Guide for HV Insulation Testers

FEATURES	Description	MI 3210 TeraOhmXA 10 kV	MI 3209 TeraOhmLT 10 kV
			
<b>MEASUREMENTS</b>	Test voltage range	50 VDC ... 10 kVDC	50 VDC ... 10 kVDC
	Voltage steps	50 V	50 V
	Insulation resistance measuring range	20 TΩ	10 TΩ
	Calculation of DD, DAR, PI	•	•
	Withstanding voltage test	•	•
	Voltage ramp test	•	•
	Leakage current measurement	•	•
	Capacitance measurement	•	•
	Short circuit / charge current	5 mA	5 mA
	Voltage measurement AC / DC	up to 600 V	up to 600 V
<b>OTHER FEATURES</b>	Custom tests	•	•
	Programmable timer	•	•
	Automatic discharge after test	•	•
	Graph R(t)	•	•
	Bar graph	•	•
	Auto adjustment function	•	•
	Auto ranging	•	•
	Audible warnings	•	•
	Guard terminal	•	•
	Shielded test leads	•	•
<b>COMMUNICATION PORTS</b>	USB/ RS232	• / •	• / •
	BLUETOOTH	•	•
<b>MEMORY, SOFTWARE</b>	Memory	•	•
	Number of memory locations	1000	1000
	Software	HVLink PRO	Option (HVLink PRO)
<b>GENERAL DATA</b>	Display type	Graphical LCD	Graphical LCD
	Backlight	•	•
	Safety category	CAT IV / 600 V	CAT IV / 600 V
	Rechargeable batteries	•	•
	Built-in battery charger	•	•
	Low battery indication	•	•
	Battery life (no load connected)	4 h at 10 kV	4 h at 10 kV
	Weight	6.5 kg	6.5 kg
	Dimensions (mm)	345 x 160 x 335	345 x 160 x 335



MI 3205 TeraOhmXA 5 kV	MI 3201 TeraOhm 5 kV Plus	MI 3202 GigaOhm 5 kV	MI 3121H Insulation/Continuity
			
50 VDC ... 5 kVDC	250 VDC ... 5 kVDC	250 VDC ... 5 kVDC	100 VDC ... 2.5 kVDC
50 V	25 V	250 V; 500 V; 1 kV; 2.5 kV; 5 kV	100 V; 250 V; 500 V; 1 kV; 2.5 kV
15 TΩ	10 TΩ	1 TΩ	100 GΩ
•	•		•
•	•		
•	•		
•	•		
•	•		
6 mA	5 mA	5 mA	3 mA
up to 600 V	up to 600 V	up to 600 V	up to 550 V
•	•		•
•	•	•	•
•	•		
•	•	•	•
•	•	•	•
•	•	•	•
•	•	•	•
•	•	•	•
•	•	•	•
• / •	• / •		
•	•		
•	•		
4 MB	1000		1500
HVLink PRO	Option (HVLink PRO)		Option (EuroLink PRO)
Graphical LCD	Graphical LCD	Custom LCD	Custom LCD
•	•	•	•
CAT IV / 600 V	CAT IV / 600 V	CAT IV / 600 V	CAT III / 600 V; CAT IV / 300 V
•	•	•	•
•	•	•	
•	•	•	
7 h at 5 kV	4 h at 5 kV	4 h at 5 kV	13 h
6.5 kg	3 kg	3 kg	850 g
345 x 160 x 335	310 x 130 x 250	310 x 130 x 250	140 x 80 x 230

# High voltage insulation testers

## MI 3210 TeraOhmXA 10 kV



MI 3210 TeraOhm XA 10 kV is a portable, battery or mains powered test instrument with excellent IP protection (IP65), intended for diagnosing of Insulation Resistance by using high DC test voltages of up to 10 kV. Because of its robustness (CAT IV protection) and high immunity to radiated RF fields it is best suited for industrial environment.

### MEASURING FUNCTIONS

- Insulation Measurement;
- Diagnostic Test (PI, DAR, DD);
- Step Voltage Test;
- Withstanding Voltage Test (DC) up to 10 kV;
- Voltage and frequency measurement up to 550 V TRMS.

### KEY FEATURES

- Insulation resistance up to 20 TΩ.
- Adjustable test voltage (50 V...10 kV) 50 V and 100 V step.
- Programmable timer.
- Capacitance measurement.
- Charging rate for capacitive load < 3 s / μF at 10 kV.
- Automatic discharge of test object after

- completion of measurement.
- Guard terminal.
- High voltage breakdown detection.
- Custom defined tests.
- Auto adjustment function.
- Measurement results in numerical and graphical form.
- PC software HVLink PRO for downloading and analysing of the test results and test report printing.
- Isolated RS232 and USB communication ports, BT interface.
- High quality accessories including shielded test leads in standard set.
- High EM interferences protection: Input AC current noise rejection (1 mA∞600 V) and additional averaging of the result (5, 10, 30, 60).
- CAT IV / 600 V.
- Mains and rechargeable battery power supply.

### APPLICATION

- Power transformers;
- Measuring transducers in distribution networks;
- Testing insulation resistance of rotating machinery and cables;
- Production line periodic testing and maintenance;
- Troubleshooting and analysis of all kinds of insulation problems;
- High voltage generators;
- Surge arrestors.

### STANDARDS

#### Electromagnetic compatibility

- EN 61326 class A

#### Safety

- EN 61010-1 (instrument);
- EN 61010-2-030;
- EN 61010-2-033;
- EN 61010-031 (accessories)

## TECHNICAL DATA

FUNCTION	Measuring range	Resolution	Accuracy
Insulation resistance	0.01 MΩ ... 9.99 MΩ	10 kΩ	±(5% of reading + 3 digits)
	10.0 MΩ ... 99.9 MΩ	100 kΩ	±(5% of reading + 3 digits)
	100 MΩ ... 999 MΩ	1 MΩ	±(5% of reading + 3 digits)
	1.00 GΩ ... 9.99 GΩ	10 MΩ	±(5% of reading + 3 digits)
	10.0 GΩ ... 99.9 GΩ	100 MΩ	±(5% of reading + 3 digits)
	100 GΩ ... 999 GΩ	1 GΩ	±(5% of reading + 3 digits)
	1.0 TΩ ... 9.9 TΩ	100 GΩ	±(5% of reading + 3 digits)
	10 TΩ ... 20 TΩ	1 TΩ	±(15% of reading + 3 digits)
Test voltage	0 V ... 999 V	1 V	±(5% of reading + 3 digits)
	1.00 kV... 9.99 kV	10 V	
	10.0 kV ... 14.0 kV	100 V	
Insulation leakage current	1.00 mA ... 5.00 mA	10 μA	
	100 μA ... 999 μA	1 μA	
	10.0 μA ... 99.9 μA	100 nA	±(5% of reading + 3 digits)
	1.00 μA ... 9.99 μA	10 nA	
	100 nA ... 999 nA	1 nA	
	10.0 nA ... 99.9 nA	100 pA	
	0.00 nA ... 9.99 nA	10 pA	±(10% of reading + 0.15 nA)
Dielectric absorption ratio (DAR)	0.01 ... 9.99	0.01	±(5% of reading + 2 digits)
	10.0 ... 100.0	0.1	
Polarization index (PI)	0.01 ... 9.99	0.01	±(5% of reading + 2 digits)
	10.0 ... 100.0	0.1	
Dielectric discharge (DD)	0.01 ... 9.99	0.01	±(5% of reading + 2 digits)
	10.0 ... 100.0	0.1	
Voltage AC/DC	5.0 V ... 99.9 V	0.1 V	±(2% of reading + 2 digits)
	100 V ... 550 V	1 V	
Frequency	10 Hz ... 500 Hz	0.1 Hz	±(0.2% of reading + 1 digits)
Capacitance	20.0 nF ... 999 nF	1 nF	±(5% of reading + 2 digits)
	1.00 μF ... 9.99 μF	10 nF	
	10.0 μF ... 50.0 μF	100 nF	
Power supply	12 V DC (3.4 Ah Lead – Acid)		
Display	320 x 240 dots matrix display with backlight		
Overvoltage category	CAT IV / 600 V		
Protection class	Double insulation		
COM port	RS232, USB and Bluetooth		
Dimensions	345 x 160 x 335 mm		
Weight	6.5 kg		

### STANDARD SET

#### MI 3210 Standard set (ST)

- Instrument MI 3210 TeraOhmXA 10 kV
- 10 kV shielded test lead with probe, 2 m
- 10 kV shielded test lead, 2 m, 2 pcs (black, red)
- 10 kV crocodile clip, 2 pcs (black, red)
- Guard test lead, green, 2 m
- Crocodile clip, green
- Mains cable
- PC SW HVLink PRO with USB and RS 232 cable
- Handbook "Guide to modern insulation testing" on storage media
- Instruction manual on storage media
- Calibration certificate

#### MI 3210 Euro set (EU)

- Instrument MI 3210 TeraOhmXA 10 kV
- 10 kV shielded test lead with probe, 2 m
- Large HV Crocodile with shielded cable, 2.5 m, 2 pcs (black, red)
- Guard test lead, green, 2.5 m
- Crocodile clip, green
- Mains cable
- PC SW HVLink PRO with USB and RS 232 cable
- Handbook "Guide to modern insulation testing" on storage media
- Instruction manual on storage media
- Calibration certificate



Picture of MI 3210 ST set



Picture of MI 3210 EU set

# High voltage insulation testers

## MI 3209 TeraOhmLT 10kV



The MI 3209 TeraOhm LT 10kV is a portable insulation resistance tester for insulation testing with DC voltages of up to 10 kV. Boasting excellent IP protection (IP65) and being both mains and battery powered, it is at home in even the most demanding working environments.

### MEASURING FUNCTIONS

- Insulation measurement;
- Diagnostic test (PI, DAR, DD);
- Step voltage test;
- Withstanding voltage test (DC) up to 10 kV;
- Voltage and frequency measurement up to 550 V TRMS.

### KEY FEATURES

- Measurement range of insulation resistance up to 10 TΩ.
- Adjustable test voltage in steps of 50 V (50 V ... 1 kV) and 100 V (1 kV ... 10 kV).
- Programmable timer.
- Capacitance measurement.
- Charging rate for capacitive load < 3 s / μF at 10 kV.
- Automatic discharge of test object after

- completion of measurement.
- Guard terminal.
- High voltage breakdown detection.
- Auto adjustment function.
- Measurement results in numerical and graphical form.
- PC software HVLink PRO for downloading and analysing of the test results and test report printing (optional).
- Isolated RS-232 and USB communication ports.
- High quality accessories including shielded test leads in standard set.
- High EM interferences protection: input AC current noise rejection (1 mA∞600 V) and additional averaging of the result (5, 10, 30, 60).
- CAT IV / 600 V.
- Mains and rechargeable battery power supply.

### APPLICATION

- Testing of power transformers;
- Measuring transducers in distribution networks;
- Insulation resistance testing of rotating machinery and cables;
- Production line periodic testing and maintenance;
- Troubleshooting and analysis of all kinds of insulation problems;
- Testing of high voltage generators;
- Testing of surge arrestors.

### STANDARDS

#### Electromagnetic compatibility

- EN 61326 class A

#### Safety

- EN 61010-1 (instrument)
- EN 61010-2-030
- EN 61010-2-033
- EN 61010-031 (accessories)

## TECHNICAL DATA

FUNCTION	Measuring range	Resolution	Accuracy
Insulation resistance @ 10 kV	0.01 MΩ ... 9.99 MΩ	10 kΩ	±(5% of reading + 3 digits)
	10.0 MΩ ... 99.9 MΩ	100 kΩ	±(5% of reading + 3 digits)
	100 MΩ ... 999 MΩ	1 MΩ	±(5% of reading + 3 digits)
	1.00 GΩ ... 9.99 GΩ	10 MΩ	±(5% of reading + 3 digits)
	10.0 GΩ ... 99.9 GΩ	100 MΩ	±(5% of reading + 3 digits)
	100 GΩ ... 999 GΩ	1 GΩ	±(5% of reading + 3 digits)
	1.0 TΩ ... 9.9 TΩ	100 GΩ	±(15% of reading + 1 digits)
Test voltage	0 V ... 999 V	1 V	±(5% of reading + 3 digits)
	1.00 kV... 9.99 kV	10 V	
	10.0 kV ... 14.0 kV	100 V	
Insulation leakage current	1.00 mA ... 5.00 mA	10 μA	
	100 μA ... 999 μA	1 μA	
	10.0 μA ... 99.9 μA	100 nA	±(5% of reading + 3 digits)
	1.00 μA ... 9.99 μA	10 nA	
	100 nA ... 999 nA	1 nA	
	10.0 nA ... 99.9 nA	100 pA	
	0.00 nA ... 9.99 nA	10 pA	±(10% of reading + 0.15 nA)
Dielectric absorption ratio (DAR)	0.01 ... 9.99	0.01	±(5% of reading + 3 digits)
	10.0 ... 100.0	0.1	
Polarization index (PI)	0.01 ... 9.99	0.01	±(5% of reading + 2 digits)
	10.0 ... 100.0	0.1	
Dielectric discharge (DD)	0.01 ... 9.99	0.01	±(5% of reading + 2 digits)
	10.0 ... 100.0	0.1	
Voltage AC/DC	5.0 ... 49.9 V	0.1 V	±(2% of reading + 2 digits)
	50 ... 550 V	1 V	
Frequency	10 Hz ... 500 Hz	0.1 Hz	±(0.2% of reading + 1 digits)
Capacitance	20.0 nF ... 999 nF	1 nF	±(5% of reading + 3 digits)
	1.00 μF ... 9.99 μF	10 nF	
	10.0 μF ... 50.0 μF	100 nF	
Nominal mains power supply	100-240 V <sub>AC</sub> , 45-65 Hz, 100 VA (CAT II / 300 V)		
Battery power supply	12 V <sub>DC</sub> (3.4 Ah lead-acid)		
Battery operation time	> 3 h continuous testing of 100 MΩ load @ 10 kV > 5 h continuous testing of 100 MΩ load @ 5 kV		
Display	320 x 240 dots matrix display with backlight		
Degree of protection	IP 65 (case closed)		
Overvoltage category	CAT IV / 600 V		
COM port	RS-232, USB		
Dimensions	345 x 160 x 335 mm		
Weight	6.5 kg (with battery and accessories)		

## STANDARD SET

### MI 3209 Standard set (ST)

- Instrument MI 3209 TeraOhmLT 10 kV
- 10 kV shielded test lead, 2 m, 2 pcs (black, red)
- 10 kV crocodile clip, 2 pcs (black, red)
- Guard test lead, green, 2 m
- Crocodile clip, green
- Mains cable
- Handbook "Guide to modern insulation testing" on storage media
- Instruction manual on storage media
- Calibration certificate



Picture of MI 3209 ST set

# High voltage insulation testers

## MI 3205 TeraOhmXA 5 kV



MI 3205 TeraOhmXA 5kV is a portable battery (Li-ion) or mains powered test instrument with excellent IP protection (IP65 case closed and IP54 case open), intended for diagnosing of Insulation Resistance by using high test voltages of up to 5 kV. It is designed and produced with the extensive knowledge and experience acquired through many years of working in this field.

### MEASURING FUNCTIONS

- Insulation measurements;
- Diagnostic testing (PI, DAR, DD);
- Step voltage test;
- Withstanding voltage test (DC) up to 5 kV;
- Voltage and frequency measurement up to 550 V TRMS.

### KEY FEATURES

- Insulation resistance up to 15 TΩ.
- Adjustable test voltage (50 V...5 kV) 50 V and 100 V step.
- Programmable timer.
- Capacitance measurement.
- Charging rate for capacitive load < 1.5 s / μF at 5 kV.
- Automatic discharge of test object after completion of measurement.
- Guard terminal.
- High voltage breakdown detection.

- Custom defined tests.
- Auto adjustment function.
- Measurement results in numerical and graphical form.
- PC software HVLink PRO for downloading and analysing of the test results and test report printing.
- Isolated RS232 and USB communication ports, BT interface.
- High quality accessories including shielded test leads in standard set.
- High EM interferences protection: Input AC current noise rejection (1 mA@300 V) and additional averaging of the result (5, 10, 30, 60).
- CAT IV / 600 V.
- Increased working nominal altitude to 3000 m.
- High power Li-ion battery pack (14.8V, 4.4Ah).
- Mains and rechargeable battery power supply.

### APPLICATION

- Power transformers;
- Measuring transducers in distribution networks;
- Testing insulation resistance of rotating machinery and cables;
- Production line periodic testing and maintenance;
- Troubleshooting and analysis of all kinds of insulation problems;
- High voltage generators;
- Surge arrestors and varistors.

### STANDARDS

#### Electromagnetic compatibility

- EN 61326 class A

#### Safety

- EN 61010-1 (instrument)
- EN 61010-2-030
- EN 61010-2-033
- EN 61010-031 (accessories)

## TECHNICAL DATA

FUNCTION	Measuring range	Resolution	Accuracy
Insulation resistance	0.01 MΩ ... 9.99 MΩ	10 kΩ	±(5% of reading + 3 digits)
	10.0 MΩ ... 99.9 MΩ	100 kΩ	±(5% of reading + 3 digits)
	100 MΩ ... 999 MΩ	1 MΩ	±(5% of reading + 3 digits)
	1.00 GΩ ... 9.99 GΩ	10 MΩ	±(5% of reading + 3 digits)
	10.0 GΩ ... 99.9 GΩ	100 MΩ	±(5% of reading + 3 digits)
	100 GΩ ... 999 GΩ	1 GΩ	±(5% of reading + 3 digits)
	1.0 TΩ ... 9.9 TΩ	100 GΩ	±(15% of reading + 3 digits)
	10 TΩ ... 15 TΩ	1 TΩ	±(15% of reading + 3 digits)
Test voltage	0 V ... 999 V	1 V	±(5% of reading + 3 digits)
	1.00 kV... 4.99 kV	10 V	
Insulation leakage current	1.00 mA ... 5.00 mA	10 μA	
	100 μA ... 999 μA	1 μA	
	10.0 μA ... 99.9 μA	100 nA	±(5% of reading + 3 digits)
	1.00 μA ... 9.99 μA	10 nA	
	100 nA ... 999 nA	1 nA	
	10.0 nA ... 99.9 nA	100 pA	
	0.00 nA ... 9.99 nA	10 pA	±(10% of reading + 0.15 nA)
Dielectric absorption ratio (DAR)	0.01 ... 9.99	0.01	±(5% of reading + 3 digits)
	10.0 ... 100.0	0.1	
Polarization index (PI)	0.01 ... 9.99	0.01	±(5% of reading + 2 digits)
	10.0 ... 100.0	0.1	
Dielectric discharge (DD)	0.01 ... 9.99	0.01	±(5% of reading + 2 digits)
	10.0 ... 100.0	0.1	
Capacitance	20.0 nF ... 999 nF	1 nF	±(5% of reading + 3 digits)
	1.00 μF ... 9.99 μF	10 nF	
	10.0 μF ... 50.0 μF	100 nF	
True RMS voltmeter (DC, 45 Hz ... 65 Hz)	5 V ... 550 V		±(2 % of reading + 2 digits)
Frequency	10 Hz ... 500 Hz		±(0.2 % of reading + 1 digit)
Power supply	90-260 VAC, 45-65 Hz or 14.4 VDC (4.4 Ah Li-Ion)		
Protection degree close / open case	IP 65 / IP 54		
Display	320 x 240 dots matrix display with backlight		
Overvoltage category	CAT IV / 600 V		
Protection class	Reinforced insulation 		
Degree of protection	IP 65 (case closed)		
	IP 54 (case open)		
COM port	RS232, USB and Bluetooth		
Dimensions	345 x 160 x 335 mm		
Weight	6.5 kg		

### STANDARD SET

#### MI 3205 Standard set (ST)

- Instrument MI 3205 TeraOhmXA 5 kV
- 10 kV shielded test lead, 2 m, 2 pcs (black, red)
- 10 kV crocodile clip, 2 pcs (black, red)
- Guard test lead, green, 2 m
- Crocodile clip, green
- Mains cable
- PC SW HVLink PRO with USB and RS 232 cable
- Handbook "Guide to modern insulation testing" on CD
- Instruction manual on CD
- Calibration certificate

#### MI 3205 Euro set (EU)

- Instrument MI 3205 TeraOhmXA 5 kV
- Large HV Crocodile with cable, red, 2.5 m
- Large HV Crocodile with shielded cable, black, 2.5 m
- Guard test lead, green, 2.5 m
- Crocodile clip, green
- Mains cable
- PC SW HVLink PRO with USB and RS 232 cable
- Handbook "Guide to modern insulation testing" on CD
- Instruction manual on CD
- Calibration certificate



Picture of MI 3205 ST set



Picture of MI 3205 EU set

# High voltage insulation testers

## MI 3201 TeraOhm 5 kV Plus



The new insulation tester MI 3201 TeraOhm 5 kV Plus is a portable instrument intended to measure insulation resistance by using high DC test voltages up to 5 kV. TeraOhm 5 kV Plus enables insulation resistance measurements up to 10 TΩ, step voltage test, withstanding voltage test, PI, DD and DAR calculation and capacitance measurement. The large LCD screen enables real-time graph R(t) to be displayed. Results can be stored and downloaded to a computer via USB or RS232 connection with the help of the optional HVLink PRO software. The high quality instrument, shielded test leads and quality accessories included in the standard set enable to perform insulation testing quickly and effectively.

High Voltage Insulation / Continuity / Earth / Transformer

### MEASURING FUNCTIONS

- Insulation resistance measurement;
- Step voltage insulation resistance testing;
- Withstanding voltage testing;
- Diagnostic test (PI, DD, DAR);
- R(t) graph plotting;
- Capacitance measurement;
- Voltage measurement;
- Frequency measurement.

### KEY FEATURES

- **Measuring range** up to 10 TΩ.
- **Wide range of DC test voltages:** from 250 V up to 5000 V in steps of 25 V.
- **Withstanding voltage:** testing of insulation with programmable ramp test voltage from 250 V up to 5 kV and programmable threshold current.
- **Step voltage:** insulation resistance measurement with five discrete proportionately set test voltages and programmable timer per step.
- **Automated testing:** PI, DD, DAR calculations with automated resistance ranging. All data is displayed during one single measurement.

- **Guard test terminal:** for elimination of potential surface leakage currents.
- **Fault finding:** fully programmable step voltage and withstanding voltage test functions assist in diagnosing faults in insulation.
- **Graph R(t):** real time resistance against time graph plotting facility to graphically illustrate the response of a material to an applied test voltage.
- **Built-in timer:** programmable timer from 1 s up to 10+0 min.
- **Automatic discharge** of tested object after test.
- **Fast testing:** 5 mA current source for quick charging of capacitive load.
- **Accurate:** selectable noise rejection filters and shielded test leads included in a standard set ensure accurate measurement.
- **Safe:** high CAT IV / 600 V voltage protection.
- **Built-in charger & rechargeable batteries:** instrument has a built-in charger and comes complete with a set of rechargeable NiMH batteries.
- **Portable:** lightweight 3 kg design with carry handle and shoulder strap.

### APPLICATION

- Testing insulation resistance of rotating machinery, cables, transformers, HV generators, surge arresters;
- Production line periodic testing and maintenance;
- Troubleshooting and analysis of all kinds of insulation problems;
- Diagnostic testing.

### STANDARDS

#### Functionality

- IEC/EN 61557-2

#### Electromagnetic compatibility

- EN 61326 class B

#### Safety

- EN 61010-1;
- EN 61010-031



## TECHNICAL DATA

FUNCTION	Measuring range	Resolution	Accuracy
Insulation resistance	5 k $\Omega$ ... 999 k $\Omega$	1 k $\Omega$	$\pm(5\%$ of reading + 3 digits)
	1.00 M $\Omega$ ... 9.99 M $\Omega$	10 k $\Omega$	$\pm(5\%$ of reading + 3 digits)
	10.0 M $\Omega$ ... 99.9 M $\Omega$	100 k $\Omega$	$\pm(5\%$ of reading + 3 digits)
	100 M $\Omega$ ... 999 M $\Omega$	1 M $\Omega$	$\pm(5\%$ of reading + 3 digits)
	1.00 G $\Omega$ ... 9.99 G $\Omega$	10 M $\Omega$	$\pm(5\%$ of reading + 3 digits)
	10.0 G $\Omega$ ... 99.9 G $\Omega$	100 M $\Omega$	$\pm(5\%$ of reading + 3 digits)
	100 G $\Omega$ ... 999 G $\Omega$	1 G $\Omega$	$\pm(5\%$ of reading + 3 digits)
	1.00 T $\Omega$ ... 10.00 T $\Omega$	10 G $\Omega$	$\pm(15\%$ of reading + 3 digits)
Test voltage	0 V ... 5500 V	1 V	$\pm(3\%$ of reading + 3 V)
Insulation leakage current	0.00 nA ... 9.99 nA	0.01 nA	$\pm(5\%$ of reading + 0.05 nA)
	10.0 nA ... 99.9 nA	0.1 nA	
	100 nA ... 999 nA	1 nA	
	1.00 $\mu$ A ... 9.99 $\mu$ A	10 nA	
	10.0 $\mu$ A ... 99.9 $\mu$ A	100 nA	
	100 $\mu$ A ... 999 $\mu$ A	1 $\mu$ A	
	1.00 mA ... 5.50 mA	10 $\mu$ A	
Dielectric absorption ratio (DAR)	0.01 ... 9.99	0.01	$\pm(5\%$ of reading + 2 digits)
	10.0 ... 100.0	0.1	$\pm 5\%$ of reading
Polarization index (PI)	0.01 ... 9.99	0.01	$\pm(5\%$ of reading + 2 digits)
	10.0 ... 100.0	0.1	$\pm 5\%$ of reading
Dielectric discharge (DD)	0.01 ... 9.99	0.01	$\pm(5\%$ of reading + 2 digits)
	10.0 ... 100.0	0.1	$\pm 5\%$ of reading
Voltage AC / DC	0 V ... 600 V	1 V	$\pm(3\%$ of reading + 4 V)
Frequency	45.0 Hz ... 65.0 Hz	0.1 Hz	$\pm 0.2$ Hz
Capacitance	0.0 nF ... 99.9 nF	0.1 nF	$\pm(5\%$ of reading + 4 nF)
	100 nF ... 999 nF	1 nF	
	1.00 $\mu$ F ... 50.00 $\mu$ F	10 nF	
Power supply	6 $\times$ 1.2 V NiMH rechargeable batteries, type C		
Display	Matrix LCD with backlight, 160 x 116 dots		
Overvoltage category	CAT IV / 600 V		
Protection class	Double insulation		
COM port	RS232 and USB		
Dimensions	310 x 130 x 250 mm		
Weight	3 kg		

### STANDARD SET

#### MI 3201

- Instrument TeraOhm 5 kV Plus
- Small soft carrying bag
- Mains cable
- 10 kV shielded test lead with probe, black, 2 m
- 10 kV shielded test lead with probe, red, 2 m
- 10 kV crocodile clip, 2 pcs (black, red)
- Guard lead, green, 2 m
- Crocodile clip, green

- 6 x 1.2 V NiMH rechargeable batteries, type C
- Handbook on storage media
- Instruction manual
- Calibration certificate



Picture of MI 3201 set

# High voltage insulation testers

## MI 3202 GigaOhm 5 kV



The MI 3202 GigaOhm 5 kV provides quick and accurate testing of insulation resistance. Five test voltages up to 5 kV and 1 TΩ resistance measuring range cover most of the industrial and power distribution applications. The large analogue / digital LCD screen with backlight offers easy reading of test results. The instrument is placed in a rugged carrying case which allows to use it in harsh environments.

### MEASURING FUNCTIONS

- Insulation resistance measurement;
- Voltage measurement;
- Frequency measurement.

### KEY FEATURES

- **Measuring range** up to 1 TΩ.
- **Analogue scale and digital LCD:** measuring results are displayed both in numeric and analogue form.
- **Quick set-up:** quick and easy selection of test voltage (250 V; 500 V; 1 kV; 2,5 kV; 5 kV).

- **Fast testing:** 5 mA current source for quick charging of capacitive load.
- **Guard test terminal:** for elimination of potential surface leakage currents.
- **Automatic discharge** of tested object after test.
- **Safe:** high CAT IV / 600 V voltage protection.
- **Easy to read:** large bright LCD with backlight.
- **Built-in charger & rechargeable batteries:** instrument has a built-in charger and comes complete with a set of rechargeable NiMH batteries.
- **High quality accessories:** shielded test leads are included in a standard set.
- **Portable:** lightweight 3 kg design with carry handle and shoulder strap.

### APPLICATION

- Testing insulation resistance of rotating machinery and cables;
- Production line periodic testing and maintenance;
- Troubleshooting and analysis of all kinds of insulation problems.

### STANDARDS

#### Functionality

- IEC/EN 61557-2

#### Electromagnetic compatibility

- EN 61326 class B

#### Safety

- EN 61010-1;
- EN 61010-031

## TECHNICAL DATA

FUNCTION	Measuring range	Resolution	Accuracy
Insulation resistance	5 k $\Omega$ ... 999 k $\Omega$	1 k $\Omega$	$\pm(5\%$ of reading + 3 digits)
	1.00 M $\Omega$ ... 9.99 M $\Omega$	10 k $\Omega$	$\pm(5\%$ of reading + 3 digits)
	10.0 M $\Omega$ ... 99.9 M $\Omega$	100 k $\Omega$	$\pm(5\%$ of reading + 3 digits)
	100 M $\Omega$ ... 999 M $\Omega$	1 M $\Omega$	$\pm(5\%$ of reading + 3 digits)
	1.00 G $\Omega$ ... 9.99 G $\Omega$	10 M $\Omega$	$\pm(5\%$ of reading + 3 digits)
	10.0 G $\Omega$ ... 99.9 G $\Omega$	100 M $\Omega$	$\pm(5\%$ of reading + 3 digits)
	100 G $\Omega$ ... 999 G $\Omega$	1 G $\Omega$	$\pm(10\%$ of reading + 3 digits)
Test voltage	0 V ... 5500 V	1 V	$\pm(3\%$ of reading + 3 V)
Voltage AC / DC	0 V ... 600 V	1 V	$\pm(3\%$ of reading + 4 V)
Frequency	45.0 Hz ... 65.0 Hz	0.1 Hz	$\pm 0.2$ Hz
Battery power supply	6 x 1.2 V NiMH rechargeable batteries, type C		
Display	Analogue / digital LCD with backlight		
Overvoltage category	CAT IV / 600 V		
Protection class	Double insulation		
Dimensions	310 x 130 x 250 mm		
Weight	3 kg		

### STANDARD SET

#### MI 3202

- Instrument GigaOhm 5 kV
- Mains cable
- 10 kV shielded test lead with probe, black, 2 m
- 10 kV shielded test lead with probe, red, 2 m
- 10 kV crocodile clip, 2 pcs (black, red)
- Guard lead, green, 2 m
- Crocodile clip, green
- 6 x 1.2 V NiMH rechargeable batteries, type C

- Handbook on storage media
- Instruction manual
- Calibration certificate



Picture of MI 3202 set

# High voltage insulation testers

## MI 3121H SMARTEC 2,5 kV Insulation / Continuity



The MI 3121H Smartec 2,5 kV Insulation / Continuity is the portable measuring instrument for complete diagnostic testing of insulation and continuity measurements. Due to insulation resistance measurement with the test voltages up to 2.5 kV (measuring range is up to 100 GΩ) and calculation of PI and DAR indexes the instrument is suited for testing insulation of cable lines, current and voltage transformers, electric motors, etc. Due to configurable limits the instrument enables PASS / FAIL evaluation of test results which is accompanied with bright green or red light of LEDs. Additional features include magnetic holder for fixing the tester on the metal surface and built-in charger. The MI 3121H is compatible with EuroLink PRO software which enables downloading and analysis of test results and creation of professional test reports.

### MEASURING FUNCTIONS

- Insulation resistance with DC voltage up to 2.5 kV;
- Diagnostic test (PI, DAR calculation);
- Continuity of PE conductors with 200 mA test current and polarity change;
- Continuity of PE conductors with 7 mA test current (continuous measurement) without RCD tripping;
- TRMS voltage and frequency.

### KEY FEATURES

- **High measuring range:** up to 100 GΩ with test voltage from 100 to 2500 V.
- **Insulation diagnostics:** PI and DAR calculation for determining if the insulation damaged or contaminated.
- **Guard test terminal:** for elimination of potential surface leakage currents.
- **Polarity swap:** automatic polarity reversal on continuity test.

- **Analogue scale:** measuring results are displayed in numeric and analogue representation.
- **Custom limits:** if limits are set on insulation or continuity function then large green and red lights of the LEDs will indicate a PASS or FAIL evaluation of test result.
- **Safe:** suited for testing on CAT IV installations.
- **Built-in charger & rechargeable batteries:** instrument has a built-in charging circuit and comes complete with a set of rechargeable NiMH batteries.
- **Memory:** two level memory structure for saving of test results and parameters.
- **Downloadable:** downloads via RS232 or USB cable directly to the PC with the help of the PC software EuroLink PRO.
- **Easy to use:** large bright LCD display and large buttons enable easy handling of the instrument (even while wearing gloves).
- **Magnetic holder:** magnet for fixing instrument on metal surfaces enables hands-free operation.

### APPLICATION

- Measurement of insulation resistance of transformers, motors, cables, machines, etc.;
- Testing on CAT IV installations (distribution side of installations, industrial plants, etc.);
- Observation of insulation trends;
- Testing of PE conductors continuity and main and supplementary PE connections.

### STANDARDS

#### Functionality

- IEC/EN 61557 Parts 1, 2, 4, 10
- IEC/EN 60364
- VDE 100
- BS 7671 17th edition
- CEI 64.8

#### Electromagnetic compatibility

- IEC/EN 61326-1;

#### Safety

- EN 61010-1;
- EN 61010-031

## TECHNICAL DATA

FUNCTION	Measuring range	Resolution	Accuracy
Insulation resistance (EN 61557-2)	U = 500, 1000, 2500 VDC: R: 0.00 MΩ ... 19.99 MΩ	0.01 MΩ	±(5 % of reading + 3 digits)
	20.0 MΩ ... 199.9 MΩ	0.1 MΩ	±5 % of reading
	200 MΩ ... 999 MΩ	1 MΩ	±5 % of reading
	1.00 GΩ ... 4.99 GΩ	10 MΩ	±10 % of reading
	5.00 GΩ ... 19.99 GΩ	10 MΩ	±20 % of reading
	20.0 GΩ ... 99.9 GΩ	100 MΩ	±20 % of reading
PI, DAR	U = 100, 250 VDC: R: 0.00 MΩ ... 19.99 MΩ	0.01 MΩ	±(5 % of reading + 3 digits)
	20.0 MΩ ... 199.9 MΩ	0.1 MΩ	±10 % of reading
	200 MΩ ... 999 MΩ	1 MΩ	±20 % of reading
Continuity 200 mA of PE conductor with polarity change (EN 61557-4)	0.01 ... 9.99	0.01	±(5 % of reading + 2 digits)
	10.0 ... 100.0	0.1	±5 % of reading
Low resistance measurement with 7 mA test current (continuous measurement)	0.00 Ω ... 19.99 Ω	0.01 Ω	±(3 % of reading + 3 digits)
	20.0 Ω ... 199.9 Ω	0.1 Ω	±5 % of reading
	200 Ω ... 1999 Ω	1 Ω	±10 % of reading
Voltage	0.0 Ω ... 19.9 Ω	0.1 Ω	±(5 % of reading + 3 digits)
	20 Ω ... 1999 Ω	1 Ω	±10 % of reading
Frequency	0.0 V ... 99.9 V	0.1 V	±(3 % of reading + 3 digits)
	100 V ... 550 V	1 V	
Power supply	0.00 Hz ... 19.99 Hz	0.01 Hz	±(0.2 % of reading + 1 digits)
	20.0 Hz ... 199.9 Hz	0.1 Hz	
	200 Hz ... 500 Hz	1 Hz	
Power supply	6 x 1.2 V rechargeable batteries, type AA		
Overvoltage category	CAT III / 600 V; CAT IV / 300 V		
Protection class	Double insulation		
COM port	RS232 and USB		
Dimensions	140 x 230 x 80 mm		
Weight	0.85 kg		

### STANDARD SET

#### MI 3121H













- Instrument Smartec 2,5 kV Insulation / Continuity
- Soft hand strap
- Test lead, 2 x 1.5 m
- Test probe, 2 pcs (black, red)
- Crocodile clip, 2 pcs (black, red)
- Power supply adapter + 6 NiMH rechargeable batteries, type AA

- Instruction manual on storage media
- Short instruction manual
- Handbook on storage media
- Calibration certificate













Picture of MI 3121H set











# Selection Guide for HV Accessories

Photo	Part number	Description	Target application	MI 3290	MI 3288	MI 3295	MI 3281	MI 3280	MI 3252	MI 3250	MI 3242	MI 3210	MI 3209	MI 3205	MI 3201	MI 3202	MI 3121H
	MI 3295M Set	Step Contact Meter Measuring Set	Additional MI 3295M Set for simultaneous measurements of step and contact voltage. With optional current clamps A 1018 or A 1587 also leakage current measurements are possible. Set includes instrument MI 3295M, test lead 2 x 3 m, soft carrying bag, soft carrying neck belt, NiMH battery type AA, 6 pcs, Power supply adapter.	•		•											
	A 1014	Test probe, black	Test probe with fi 4 mm connection is suitable for performing measurements both in mains outlets and in situations when no schuko outlet is present.														•
	A 1013	Crocodile clip, black	Crocodile clip assures secure and permanent contact during the measurement on bus bars, fixing screws, etc.														•
	A 1064	Crocodile clip, red															
	A 1309	Crocodile clip, green															•
	S 2036	HV crocodile clip, 2 pcs (red, black)	10 kV crocodile clips for HV insulation resistance measurement assure secure and permanent contact during the measurement on bus bars, fixing screws, etc.									•	•	•	•	•	•
	A 1046	1.2 V NiMH battery, type C, 6 pcs	A set of 6 pieces of rechargeable batteries, type C.														•
	A 1568	8800mAh battery pack	Li-Ion Battery pack 7.2V 8800mAh.		•												
	A 1169	Fast charger for AA, C, D and 9 V block batteries	Fast battery charger for up to 12 pcs AA, 6 pcs C or D rechargeable batteries, 4 pcs 9 V block batteries.			•			•	•					•	•	•
	A 1017	Communication cable RS232	RS232 interface cable for connecting the instrument with the PC.														•
	A 1275	PC SW HVLink PRO	HVLink PRO is a downloading and data management PC software with R=f(t) graph printing functionality (for HV insulation testers). It comes delivered with RS232 and USB communication cables.			•			•			•	•	•	•		
	A 1291	PC SW EuroLink PRO with USB and RS232-PS/2 cable	PC Software EuroLink PRO enables downloading and test results management and printing of test reports. Delivered with RS232-PS/2 and USB communication cables.														•
	A 1333 V2	Reference resistor 750 $\mu\Omega$	Reference resistor 750 $\mu\Omega$ , class 0.1, with certificate.						•	•	•						

• Option













Photo	Part number	Description	Target application	MI 3290	MI 3288	MI 3295	MI 3281	MI 3280	MI 3252	MI 3250	MI 3242	MI 3210	MI 3209	MI 3205	MI 3201	MI 3202	MI 3121H	
	A 1353	Step voltage probe (25 kg), 2 pcs	Additional voltage probes for step voltage measurements.	•		•												
	S 2053	Step voltage plates	Light replacement for 25kg Step voltage probes A 1353.	•	•	•												
	S 2058	Insulation test plates	Two in one: Test plates for measurement of floor and wall insulation, Δ625 cm <sup>2</sup> (acc. to EN 60364-6) and measurement of semi conductivity, 2,5 kg, Ø65 mm (acc. to EN 61340-5-1).									•	•	•	•	•	•	
	A 1012	Test lead, green, 4 m	Extension test lead.													•	•	
	A 1154	Test lead, black, 4 m	Extension test lead for earth and continuity measurements.															•
	A 1319	2.5 kV test lead, 3 x 1.5 m	3-wire test lead with GUARD connection for insulation resistance measurements with test voltage up to 2,5 kV. Recommended to be used when measuring high insulation resistances (>10 GΩ).															•
	A 1153	Test lead, black, 20 m	Extension test lead for earth and continuity measurements.															•
	A 1383	Temperature probe with 3 m cable	Temperature probe with measuring range from -55 °C to +125 °C for measurement of ambient temperature.									•						
	A 1437	Test lead with Kelvin probe	Test lead with Kelvin probe for fast resistance measurements.									•	•					
	A 1408	Test cable Kelvin, 2,5 m	Test cable with Kelvin clamps for easy resistance measurements with MI 3242.									•						
	S 1072	Continuity test lead, with crocodile clip, 2 x 2.5 m, 2 pcs	Kelvin test probes with crocodile clips and protection shield as lightweight alternative to clips within the standard set.	•								•	•					

• Option











Photo	Part number	Description	Target application	MI 3290	MI 3288	MI 3295	MI 3281	MI 3280	MI 3252	MI 3250	MI 3242	MI 3210	MI 3209	MI 3205	MI 3201	MI 3202	MI 3121H
	A 1649 10M	Kelvin Extension test lead	Kelvin Extension test lead with banana plugs, 10 mm <sup>2</sup> , 10 m.						•								
	S 2046	Current test lead with insulated crocodile clip, 5 m, 25 mm <sup>2</sup> , 2 pcs	100 A current test lead with insulated crocodile clip for performing accurate resistance measurements with MI 3252.						•								
	S 2128 10M S2128 15M	Set of Kelvin test leads	Set of Kelvin test leads on reel, 2 pcs and 2 fastening ropes 1 m with carabiner hook				•										
	A 1716 5M A 1716 10M A 1716 15M	Kelvin Test lead (H0-H3) 5M - HARTING	4 Kelvin test leads (H0-H3) with Harting connector, 5 m				•										
	A 1715 5M A 1715 10M A 1715 15M	Kelvin Test lead (H0-H3) 5M - HARTING	4 Kelvin test leads (H0-H3) with Harting connector, 5 m				•										
	S 2126 10M S 2126 5M	Set of test leads with big Kelvin clamps	Set of 8 test leads long, 8 pcs. of Kelvin clips with jaw opening 35 mm and two fastening ropes with carabiner hook for measurements on power transformers packed in a soft carrying bag.					•									
	A 1815 10M A 1815 5M A 1815 2M5	Test lead H0-H1	Double two wire test leads (H0-H1) with banana termination to be used together with different Kelvin clips.					•									
	A 1816 10M A 1816 5M A 1816 2M5	Test lead H2-H3	Double two wire test leads (H2-H3) with banana termination to be used together with different Kelvin clips.					•									
	A 1817 10M A 1817 5M A 1817 2M5	Test lead X0-X1	Double two wire test leads (X0-X1) with banana termination to be used together with different Kelvin clips.					•									
	A 1818 10M A 1818 5M A 1818 2M5	Test lead X2-X3	Double two wire test leads (X2-X3) with banana termination to be used together with different Kelvin clips.					•									
	A 1814	Fastening rope 1 m with carabiner hook	A rope with carabiner hook for easy fixing of long measurement cables.				•	•									

• Option







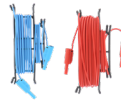





Photo	Part number	Description	Target application	MI 3290	MI 3288	MI 3295	MI 3281	MI 3280	MI 3252	MI 3250	MI 3242	MI 3210	MI 3209	MI 3205	MI 3201	MI 3202	MI 3121H
	A 1714 20M	Two wire Kelvin extension cable 20 m	Kelvin extension test cable with 20 m long leads, 4 mm <sup>2</sup> and 0,75 mm <sup>2</sup>				•	•	•								
	A 1813	OLTC control cable 10 m	On-Load-tap-changer control cable				•										
	S 2040	Earth test set, 4-wire, 20 m	Earth test set for MI 3288, 20 m (test lead, 4 x 1 m; 2 x test lead, 20 m; 2 x test lead, 4,5 m; 4 x earth test rod).		•												
	S 2123	Earth test set, 4-wire, 50 m	Earth test set for MI 3288, 50 m (test lead, 4 x 1 m; 2 x test lead, 50 m; 2 x test lead, 4,5 m; 4 x earth test rod).		•												
	S 2052	Current test lead with crocodile clip, 10 m, 50 mm <sup>2</sup> , 2 pcs	Extended 100 A current test leads for accurate measurements with MI 3252.						•								
	A 1740	Calibration box 5kV	Calibration Box for checking insulation measurements in the field (max. test voltage = 5kV).									•	•	•	•	•	•
	A 1597	Human body resistance probe	The A 1597 is an external adapter used for human body resistance simulation.		•												
	A 1593	Large Kelvin test crocodile	Large robust Kelvin crocodile clip for accurate resistance measurements on larger objects with jaw opening 35 mm.	•			•			•	•						
	A 1595	Large test crocodile, black	Large robust crocodile clip for resistance measurements on larger objects.	•						•	•						
	A 1596	Large test crocodile, red		•						•	•						
	A 1757	Large kelvin test clip 65 mm	Large Kelvin test clip with jaw opening of 65 mm for best contacting on bigger terminals.				•	•		•	•						
	A 1639 RED 2M5	10 kV test lead with large red HV test clip, 2.5 m	HV test clip with cable for best contacting of different contact surfaces with 35 mm jaw opening.									•	•	•	•	•	













• Option

Photo	Part number	Description	Target application	MI 3290	MI 3288	MI 3295	MI 3281	MI 3280	MI 3252	MI 3250	MI 3242	MI 3210	MI 3209	MI 3205	MI 3201	MI 3202	MI 3121H		
	A 1539 BLK 5M	10 kV shielded test lead with large black HV test clip	HV test clip with shielded cable for best contacting of different contact surfaces with 35 mm jaw opening.										•	•	•	•	•		
	A 1539 BLK 10M													•	•	•	•	•	
	A 1539 BLK 15M														•	•	•	•	•
	A 1939 RED 5M	10 kV shielded test lead with large red HV test clip	HV test clip with shielded cable for best contacting of different contact surfaces with 35 mm jaw opening.										•	•	•	•	•		
	A 1939 RED 10M													•	•	•	•	•	
	A 1939 RED 15M														•	•	•	•	•
	A 1655 5M	Test lead 1000 V CAT III, green	Guard test lead for insulation resistance measurements.										•	•	•	•	•		
	A 1655 10M													•	•	•	•	•	
	A 1655 15M														•	•	•	•	•
	S 1539 5M	Set 10 kV test leads with large HV test clip, 5 m	Set of HV test clips with shielded cable for best contacting of different contact surfaces with 35 mm jaw opening.												•	•	•		
	S 1539 10M															•	•	•	
	S 1539 15M															•	•	•	
	S 1939 5M	Set 10 kV shielded test leads with large HV test clip, 5 m	Set of HV test clips with shielded cable for best contacting of different contact surfaces with 35 mm jaw opening.										•	•					
	S 1939 10M														•	•			
	S 1939 15M														•	•			
	S 2029	10 kV shielded test lead, 8 m, 2 pcs	10 kV shielded test leads improve accuracy of HV insulation resistance measurement in environments with high content of external electromagnetic interferences.										•	•	•	•	•		
	S 2084			10 kV shielded test lead + guard, 8 m, 2 pcs											•	•	•	•	•
	S 2030			10 kV shielded test lead, 15 m, 2 pcs											•	•	•	•	•
	A 1018 3M5	Current clamp (low range, leakage), 3.5 m length	High accuracy current clamp 1000 A / 1 A with jaw opening 52 mm and fixed 3.5 m cable for both load and low range / leakage current measurement and for earth resistance measurement as well.	•	•														
	A 1019	Current clamp	Current clamp 1000 A / 1 A with jaw opening 52 mm for general current measurements and in combination with A 1018 for earth resistance measurement without breaking the loop.	•	•														
	A 1281	Current clamp 0,5/5/100/1000 A / 1 V	Four smart ranges current clamp 0,5/5/100/1000 A / 1 V, with jaw opening: 5.2 cm; Max. conductor size < 50 mm for measuring alternating currents in low and medium power installations. Current clamp is automatically recognized by the instrument. Clamp does not require external power supply as it is powered by the instrument.	•															
	A 1227	1-phase flexible current clamp 3000/300/30 A / 1 V	Single phase smart flexible current clamp with three selectable measuring ranges Sensor length: 48 cm; max. conductor size: 140 mm. Current clamp is automatically recognized by the instrument. Clamp does not require external power supply as it is powered by the measuring instrument.	•															
	A 1587	Flexible current clamp 3000/300/30 A	Single phase flexible current clamp with three selectable measuring ranges. With banana plug. Powered with alkaline or rechargeable batteries.		•														

• Option

Photo	Part number	Description	Target application	MI 3290	MI 3288	MI 3295	MI 3281	MI 3280	MI 3252	MI 3250	MI 3242	MI 3210	MI 3209	MI 3205	MI 3201	MI 3202	MI 3121H
	A 1487	Flexible current clamp 50 A, 5m	Flexible current clamp with circumference of 5 m and connection cable of 15 m, max. 50 A.	•													
	A 1508 EXT	Extension test lead, shielded, on reel, 75 m	Extension for current test lead, shielded, on reel, 75 m, 2 banana plugs both sides.	•													
	A 1540	Extension test lead on reel, 100 m	Extension current test lead for MI 3295, 10 mm <sup>2</sup> , length 100 m.			•											
	A 1509	Test lead 50m black on cable reel	Test lead on a cable reel, black, 50 m, extendable.	•	•												
	A 1510	Test lead 50m green on cable reel	Test lead on a cable reel, green, 50 m, extendable.	•	•												
	A 1525	Test lead 50m blue on cable reel	Test lead on a cable reel, blue, 50 m, extendable.	•	•												
	A 1526	Test lead 5m blue	Test lead, blue, 5 m, banana plug on both sides.	•	•												
	A 1527	Test lead 5m red	Test lead, red, 5 m, banana plug on both sides.	•	•												
	A 1528	Professional current earth spike 42 cm	Professional earth spike, 42 cm, with banana socket (drill).	•	•												
	A 1529	Professional current earth spike 90 cm	Professional earth spike, 90 cm, with banana socket (smooth).	•	•												
	A 1629	Current and potential earth spike, 60 cm (with 3 m lead)	For effective earth potential measurements, 60 cm.			•											
	A 1530	G clamp	Professional G clamp for perfect contacting, with banana socket.	•	•												

• Option

Photo	Part number	Description	Target application	MI 3290	MI 3288	MI 3295	MI 3281	MI 3280	MI 3252	MI 3250	MI 3242	MI 3210	MI 3209	MI 3205	MI 3201	MI 3202	MI 3121H
	P 1100	Metrel FW Profile Licence Key With BASIC SW Set	Licence key for an additional FW profile and BASIC MESM functionality.	•													
	P 1104	Metrel SDK Licence Key	SDK Licence key for instrument integration with 3rd party SW.	•	•		•	•									
	P 1101	Metrel MESM BASIC to PRO licence key Upgrade	Licence key for upgrading the Metrel ES Manager to advanced version with professional report creation and Excel PRO export functionality.	•	•		•	•									
	P 1102-AND	Metrel aMESM PRO Licence Key Upgrade	The aMESM is an advanced portable appliance safety Testing tool for Android devices. The Application is free for download from the Android Market via Google Play. For a full-featured application, a special Licence is needed. Please contact your local distributor for further information.	•			•	•									
	P 1201	MI 3290 GL licence key	for Grounding and Lightning functionality of Earth Analyser.	•													
	P 1202	MI 3290 GP licence key	for Grounding of Pylons functionality of Earth Analyser.	•													
	P 1203	MI 3290 GF licence key	for Grounding and voltage Funnel functionality of Earth Analyser.	•													
	P 1204	MI 3290 GX2 upgrade licence key	A licence key for upgrade from base functionality (GP/GL/GF) to full functionality (GX) of Earth Analyser MI 3290.	•													
	A 1737	Carrying case	Case with foam inserts with slots for a Eurotest multifunctional electrical installation safety tester and MI 3309 BT DeltaGT. Multiple possible instrument & accessory combinations. We recommend the MI 3110 EurotestIT, MI 3309 DeltaPAT, MD 9231 AC/DC current clamp and A 1207 three phase adapter combination.	•													
	S 2138	S 2138 Set of wheels for carrying cases A 1736, A 1737, A 1738	Wheels and trolley that can be added to carrying cases for easier transport.	•													
	A 1772	Carrying bag	Bag for accessories.	•		•			•								
	A 1271	Carrying bag (S)	Small soft carrying bag for transport and storage of test instrument or accessories.												•	•	•
	A 1006	Soft carrying bag	Large soft carrying bag for transport and storage of test instrument and belonging accessories.	•	•	•											•

• Option

# Content

## Appliance / Machine / Switchboard Safety

Electrical Installation Safety	1.1 - 1.72
High Voltage Insulation / Continuity / Earth / Transformer	2.1 - 2.48
<b>APPLIANCE / MACHINE / SWITCHBOARD SAFETY</b>	<b>3.1 - 3.52</b>
Power Quality Analysis	4.1 - 4.26
Equipment for laboratories and Schools	5.1 - 5.16
Multimeters / Clamp meters / Voltage testers / Thermal cameras	6.1 - 6.44
Software	7.1 - 7.19
<b>GOOD TO KNOW</b>	
Testing the Safety of Appliances	3.02
<b>PAT TESTERS</b>	
Selection Guide for GT Testers	3.04
Selection Guide for Printers, Applications and Scanners	3.05
MI 3360 OmegaGT XA	3.06
MI 3309 BT DeltaGT	3.12
MI 3311 GammaGT	3.14
<b>OTHER INSTRUMENTS / ADAPTERS / ACCESSORIES</b>	
A 1322 and A 1422 Active 3-phase Adapter	3.16
<b>GOOD TO KNOW</b>	
Testing the Safety of Machines and Switchboards	3.18
<b>MACHINE AND SWITCHBOARD TESTERS</b>	
Selection Guide for Machine and Switchboard Testers	3.20
Rack mount adapter	3.21
MI 3394 CE MultiTesterXA	3.22
MI 3394 CE MultiTesterXA SETS	3.24
MI 3325 MultiServicerXD	3.26
<b>GOOD TO KNOW</b>	
Safety of medical equipment <b>NEW</b>	3.30
<b>MEDICAL TESTERS</b>	
Selection Guide for Medical Testers <b>NEW</b>	3.33
MI 6601 MediTest <b>NEW</b>	3.34
<b>GOOD TO KNOW</b>	
End-of-line safety testing in production	3.38
<b>END-OF-LINE SAFETY TESTING IN PRODUCTION</b>	
MI 3394 CE MultiTesterXS	3.40
<b>SELECTION GUIDE FOR PAT ACCESSORIES</b>	<b>3.42</b>

# Good to know

## Testing the Safety of Appliances

### Find out more about testing safety of electrical equipment.

Primary goal of testing safety of electrical equipment is to use all electrical equipment without danger. Common accidents caused by electrical equipment are:

- Injuries through electric shock caused by malfunctioned equipment;
- Injuries through overheated equipment;
- Fire and explosions.

To prevent risk and possible danger caused by using electrical appliances and other equipment appropriate safety testing procedure should be performed. Testing of electrical equipment is not regulated the same way in all countries. For instance in Germany, UK, Australia testing of all electrical equipment is strictly regulated by law. Through their positive experience it can be assumed that other countries will follow in the future.

Safety of electrical equipment depends on different factors which can improve or worsen the safety level.

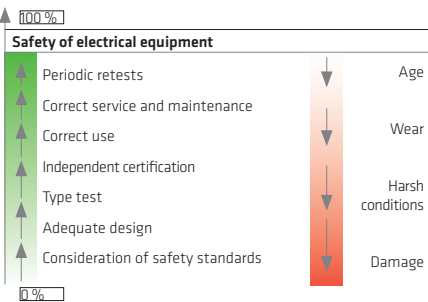

Types of safety tests of electrical equipment are:

- Type testing;
- End of line testing;
- Maintenance testing;
- Periodic testing.

According to the standards electrical equipment is divided in:

- Electrical appliances;
- Electrical equipment in medical use;
- Electrical machines;
- Electrical switchgears.

### Classification of appliances by field of use:

- Laboratory equipment;
- Measuring and regulating equipment;
- Power supplies;
- Heating appliances;
- Handheld tools;
- Luminaries;
- Consumer electronic;
- Information and communication technology (computers, fax machines, scanners, etc.);
- Prolongation cords, IEC supply cords;
- Appliances for medical use.

### Classification of appliances by protection classes:

According to the design electrical equipment can be divided in three classes.

In the table below the differences between classes are described.

Class	I	II	III
Marking	no		
Connection to protection (PE) conductor of the installation.	yes	no	no connection to mains
Basic insulation	performed	performed	performed / looser limits
Supplementary or reinforced insulation	not needed in general, needed if there are accessible unearthed metal parts 1)	performed	not needed
Supply cord	three pole (L, N, PE)	can be two pole	two pole
Notes	installation must have adequate earthing resistance		must be supplied from a SELV (safety low voltage) source, typically 12 V or 24 V

### Portable appliances - measurements:

#### Visual check

Visual test of the equipment is intended to confirm that there are no visible signs of damage or defects. Result of visual test can be stored on most of Metrel GT testers for future reference.

#### Earth bond (continuity of protective conductor) test

With the earth bond test following is determined:

- That the contacts between accessible metal parts and PE conductor are firm.
- That PE wire in the appliance supply cord is undamaged.
- That there are no signs of poor contacts, corrosion etc.



Earth bond test

Test signal is applied between PE pin of supply cord and accessible earthed metal parts.



Insulation resistance test for Class I device

High DC voltage test signal is applied between connected live pins and PE contact of supply cord. Unearthed accessible metal parts are NOT included in this test and are measured as Class II items.

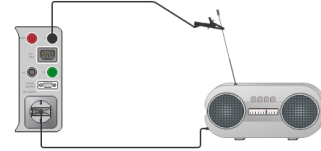

Insulation resistance test for Class II device

High DC voltage test signal is applied between connected live pins and accessible isolated metal part.

### Substitute leakage test

In this test the live and neutral conductors of the appliance are shorted together and voltage of 30 - 50 V AC is applied between this point and either the earth conductor (class I) or the probe connected to any exposed conductive part (class I and class II). The test measures how much current passes from the live conductors into the test point.



Substitute leakage test for Class I device

AC test signal is applied between connected live pins and PE contact of supply cord. Isolated accessible metal parts are NOT included in this test and are measured as Class II items.

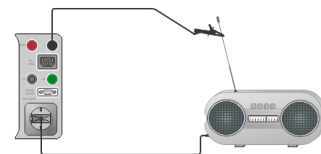

Substitute leakage test for Class II device

AC test signal is applied between connected live pins and accessible isolated metal part.

### Leakage current tests

In this test the sum of leakage currents caused by appliance insulation resistances (resistive currents through the insulation material, fault currents through decreased insulation) and capacitances (capacitive leakage current) is checked. Excessive leakage currents are most often caused by deterioration of the appliance insulation (pollution, ageing, moisture) or faults in mains circuits of appliances.

In general three leakage currents are measured: the differential leakage current, the PE conductor (direct) leakage current and the touch leakage current.

### PE conductor leakage test

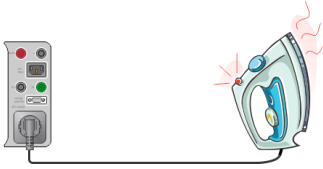

PE conductor leakage current test for Class I device

Appliance must be powered on. The current flowing through appliance PE conductor is measured. Appliance must be placed isolated against ground. Unearthed accessible metal parts are not included in this test. They are considered as class II parts and are checked in the Touch Leakage test.

### Differential leakage current test

Differential leakage measures the difference in current between the live and neutral cable which provides a true value of how much current the appliance leaks to ground.

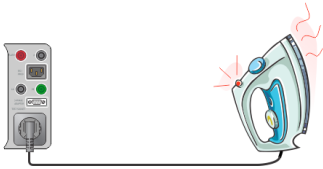

Differential leakage current test for Class I device

Appliance must be powered on. The leakage current is measured as the difference of currents through L and N conductors. Unearthed accessible metal parts are not included in this test. They are considered as class II parts and are checked in the Touch Leakage test.

### Touch leakage test

Leakage current is a current that would flow via the isolated accessible metal part (if touched) through body to ground are measured in this test.

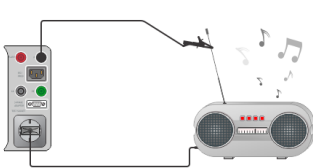

Touch leakage current test for Class II device

Appliance must be powered on. The current through the isolated accessible metal parts is measured (each part separately).

### Polarity test

Polarity test checks the correctness of polarity of IEC leads, prolongation cords etc. is checked. With this test shorts, crossed and opened wires in cords can be found.

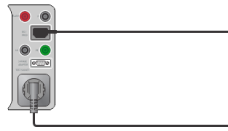

Polarity test

### Measurement of load and leakage currents with current clamps

Advantages of clamp measurements are:

- Measured electrical equipment does not need to be disconnected from the mains.
- Selective current tests can be performed by embracing individual conductors.
- Individual currents can be measured without disconnections.

Current clamps are best suited for:

- functional testing of fixed installed appliances;
- functional testing of appliances with nominal currents >16 A;
- troubleshooting of current paths in appliances.

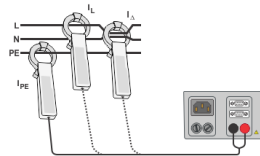

Current measurement with current clamps

Appliance must be powered on. By embracing separate conductors load or leakage currents can be measured.

### Functional test

Functional check explores if the appliance is working properly. The use of more sophisticated measuring instruments permits load testing, which is an effective way of determination if there are faults in the appliance.

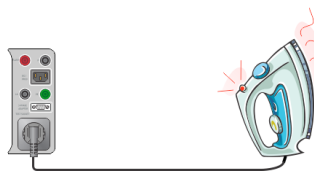

Functional test

### PRCD test

This test checks how long it takes for a portable RCD to trip out in the case that a fault occurs.

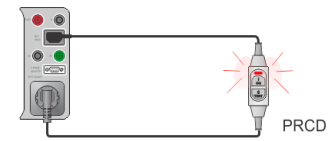

PRCD testing

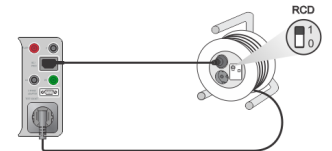

PRCD testing

### Active polarity test

This test provides testing of PRCD protected cords while voltage is applied to tested object.



Active polarity test

### Autosequences

All Metrel GT testers contain built-in predefined test sequences which are specified sets of measurements, limits and test parameters. To select the correct test sequence first the type and class of appliance must be determined. Then all safety relevant accessible conductive parts must be found. After that the test sequence, test limits and parameters must be selected. It is of a great advantage if this can be made automatically by the measuring instrument.

### Custom test sequences

In case of testing unusual appliances or appliances that require a special method of testing that is not included in the standard autosequences custom defined test sequences can be used.

### Project uploading

When retesting a site or location, project uploading allows previously saved information to be reloaded onto the GT tester to speed up testing and enable trend comparison.

### Trend comparison

Trend comparison allows test information from different dates to be compared in order to discover if deterioration is occurring in an appliance. In case the deterioration was found, the test engineer can make an informed decision as to if the frequency of testing and inspection is sufficient for the appliance.

# GT testers

## Selection Guide for GT Testers

FEATURES	Description	MI 3360 OmegaGT XA	MI 3309 BT DeltaGT	MI 3311 GammaGT
				
<b>APPLICATIONS</b>	PAT / Medical / Welding / 3PH / Service & repair	• / • <sup>1</sup> / • / • / • <sup>2</sup>	• / - / - / - / -	• / - / - / - / -
<b>MEASUREMENTS</b>	Continuity 200 mA / 10 A / 25 A	• / • <sup>3</sup> / • <sup>3</sup>	• / - / -	• / - / -
	Insulation resistance 250 VDC / 500 VDC	• / •	• / •	• / •
	Differential leakage current	•	•	
	PE Leakage	•		
	Touch leakage current	•	•	
	Substitute leakage current	•	•	•
	Leakage current measurements with optional clamp	•	•	
	Leakage current produced by a floating input (ITOU + IFI)	•		
	Leakage current produced by a floating input (IPE + IFI)	•		
	Equipment leakage (direct, differential, alternative)	• <sup>1</sup>		
	Applied part leakage (direct, alternative)	• <sup>1</sup>		
	Patient leakage (IpME)	• <sup>1</sup>		
	Welding circuit leakage (optional A 1422)	•		
	Primary leakage (optional A 1422)	•		
	No-load voltage (optional A 1422)	•		
	Flash test (1500 V, 3000 V)	• <sup>2</sup>		
	RCD testing	AC / A / B	AC / A <sup>4</sup>	
	PRCD testing / Extended PRCD testing	• / •	• / -	
	Polarity test (IEC lead test) / Active polarity	• / •	• / -	• / -
	Functional (load) test	•	•	
	Voltage TRMS		•	•
	Enhanced TRMS test		•	
	<b>ADDITIONAL FEATURES</b>	PASS / FAIL evaluation	•	•
Mains supply check		•	•	•
Built-in Checkbox				•
Graphical LCD / Touch screen		• / •	• / -	• / -
Graphical on-line help		•	•	•
Real time clock		•	•	•
QWERTY keyboard		Option		
Auto testing (organizer, custom autotests)		•	•	•
QR-code shortcut auto testing / Barcode		• / •	• / •	• / •
Communication ports USB / RS232 / BLUETOOTH		• / • / •	• / • / •	• / • / Option
“Test and tag” (barcode scanner + label printer)		•	•	•
Data download to PC		•	•	•
Project upload from PC		•		
PC SW PATlink PRO / MESM	- / •	• / •	• / -	
Number of memory locations	SD 8GB (up to 32GB)	1500	1500	
<b>STANDARD / OPTIONAL ACCESSORIES</b>	QR-code custom testing	Option	Option	Option
	Barcode scanner	Option	Option	Option
	Barcode label printer	Option	Option	Option
	QR label printer	Option	Option	Option
	Basic PC SW	•	•	Option
	Advanced PC SW	Option	Option	Option
	Android app	Option	Option	Option
	3PH active adapter	Option		
NFC	Option			
<b>GENERAL DATA</b>	Weight	6.1 kg	0.86 kg	0.86 kg
	Dimensions (mm)	310 x 130 x 250	140 x 80 x 230	140 x 80 x 230

<sup>1</sup> MI 3360 M only

<sup>2</sup> MI 3360 F only

<sup>3</sup> MI 3360 25A, M, F only

<sup>4</sup> RCD t only



# GT testers

## Selection Guide for Printers, Apps and Scanners

INSTRUMENT			MI 3360 OmegaGT XA	MI 3325 MultiServicerXD	MI 3309 BT DeltaGT	MI 3311 GammaGT								
INSTRUMENT HW VERSION							HW 3							
BLUETOOTH COMMUNICATION							Built in BLUETOOTH		Bluetooth via external DONGLE					
			Available at local authorised reseller		REGION									
			EU incl. UK	AUS/NZ	Barcode	QR	NFC	Barcode	QR	NFC	Barcode	QR		
														
PRINTER	CABLE ONLY	 A 1489 Able printer	•		•	•					•	•		
	CABLE OR BLUETOOTH	 S 2062 Zebra BT label printer set	•	•	•	•		•			•	•	•	•
	CABLE ONLY	 A 1488 Able printer	•		•	•					•	•	•	•
	BLUETOOTH VIA ANDROID	 RW 220 Zebra mobile printer	•	•	•	•		•				•*		
	BLUETOOTH VIA ANDROID	 P4T Zebra mobile printer	•	•	•	•		•				•*		
ANDROID APP	BLUETOOTH	 A 1434 aPAT Android	•	•							•	•		
	BLUETOOTH	 A 1433 PATLink Android	•	•							•	•	•	•
	BLUETOOTH	 A 1521 aMESM	•	•	•	•		•						
SCANNER	CABLE	 A 1105 Barcode scanner	•	•	•			•			•		•	
	CABLE	 A 1571 NFC reader / writer	•	•			•		•					
	BLUETOOTH	 A 1652 Barcode scanner	•	•	•			•			•*			
	BLUETOOTH	 A 1653 QR/Barcode scanner	•	•	•	•		•						

\* Supported via Android app aPAT only  
 \*\* Printing via APP supported only from S 2062

# PAT testers

## MI 3360 OmegaGT XA



New series of OmegaGT XA brings 4 models of the instrument, intended for professional use in the most demanding applications. All of them support user accounts, which means that one device can be used by several electricians. Model versions cover the following fields of testing: portable appliances, welding equipment, medical devices and professional testing of PRCD devices. All instruments have an advanced built-in user interface that enables the execution of pre-defined and user-created AUTOSEQUENCE<sup>®</sup>s. Large memory capacity (8 GB microSD card) enables the user long term saving and archiving of data. All the instruments are specially designed for long-term testing, since their memory structure enables simple searching through the archive of devices and quick re-execution of (periodic) tests. Great emphasis was put on support for peripheral devices such as printers and barcode or QR code scanners and RFID readers (in Bluetooth and wired versions). On top of that, all instrument versions are supported by our Metrel ES Manager PC software.

### MEASURING FUNCTIONS

- Visual inspections;
- Fuse test;
- Continuity // Protective earth resistance 200 mA;
- Continuity // Protective earth resistance 10 A, 25 A (25A, M, F, models only);
- Insulation Resistance (Riso, Riso-S);
- Sub-Leakage Current, Substitute Leakage Current - S;
- Differential Leakage current;
- PE leakage current;
- Touch leakage current;
- Leakage current produced by a floating input (Itou + IFI);
- Leakage current produced by a floating input (IPE + IFI);
- Insulation resistance, IEC/EN 62353 (M, model only);
- Touch leakage current, IEC/EN 62353; IEC 60601 (M, model only);
- Equipment leakage (direct, differential, alternative) IEC/EN 62353 (M, model only);
- Applied part leakage (direct, alternative), IEC/EN 62353 (M, model only);
- Patient leakage (IpME), IEC/EN 62353, IEC 60601 (M, model only);
- Insulation resistance, (optional A 1422) IEC/EN 60974-4;
- Welding circuit leakage, (optional A 1422) IEC/EN 60974-4;
- Primary leakage, (optional A 1422) IEC/EN 60974-4;
- No-load voltage, (optional A 1422) IEC/EN 60974-4;

- Power (P, S, Q, PF, THDu, THDi, Cos $\phi$ , I, U);
- PRCD test, (2-pole, 3-pole, K/Di (varistor), S (3-pole));
- PRCD PE probe test, PRCD open conductor test, PE conductor (PRCD) test;
- RCD test, (type A, AC, B, B+, F);
- Flash test, (1500 V, 3000 V), (F, model only);
- Polarity / Active polarity test;
- Clamp current (with optional A 1579).

### KEY FEATURES

- Touch screen: high resolution colour touch screen, 4.3" TFT.
- Double manipulation: keyboard and touch screen enable the user to control the instrument in any manner they like.
- Pre-defined AUTOSEQUENCE<sup>®</sup>s: enable the user simple and quick execution of test sequence for the chosen device.
- Read the code and test: QR and barcode system of labelling in combination with AUTOSEQUENCE<sup>®</sup>s enables the user quick and simple testing of electrical devices.
- Testing groups: the instruments have built-in filters in accordance with their area of application, which enables the user simple choice of needed test sequences.
- Support for PRCD testing: support for all types of PRCDs, including 2-pole, 3-pole, K/Di (varistor), S (3 pole) and testing with the PE probe.
- Support for RCD testing: all instruments support testing of A, AC, B, B+ and F RCDs.
- Fuse testing: the instrument has a special, integrated testing module for quick testing of all types of fuses.

- Hard-wired devices: the instruments have integrated additional test terminals that enable the user simple testing of hard-wired devices.
- High-voltage testing (only MI 3360 F): the instrument enables insulation resistance measurement that has to be performed after repairs or maintenance of electrical devices.
- Testing of medical devices (only MI 3360 M): the instrument enables testing of medical devices in accordance with IEC/EN 62353 extended to tests in acc. with IEC 60601.
- Testing of Audio/video, information and communication technology equipment (only in combination with A 1789 SFC adapter): all models of OmegaGT XA support testing of Audio/video, information and communication technology equipment IEC/EN 62368.
- Testing of welding equipment (only in combination with A 1422): all models of OmegaGT XA support testing of welding equipment in accordance with IEC/EN 60974-4.
- Large memory: support for microSD memory cards, 8 GB card already integrated in the instrument, although that can be expanded to 32 GB.
- PC SW Metrel ES Manager: enables creation of test structures, user-defined AUTOSEQUENCE<sup>®</sup>s, professional test reports and data transfer for archiving.
- aMESM Android SW: enables QR code scanning, and uploading of pre-prepared user-defined AUTOSEQUENCE<sup>®</sup>s.

## TECHNICAL DATA

**Continuity / Protective earth resistance** Continuity 200mA, (10A, 25A, only at models: MI 3360 25A, MI 3360 M, MI 3360 F)

FUNCTION	Measuring range	Resolution	Accuracy
R	0.00 Ω ... 19.99 Ω	0.01 Ω	±(2 % of reading + 2 D)
	20.0 Ω ... 99.9 Ω	0.1 Ω	± 3 % of reading
	100.0 Ω ... 199.9 Ω	0.1 Ω	± 5 % of reading
	200 Ω ... 999 Ω	1 Ω	indicative

**Insulation Resistance (Riso, Riso-S)** Insulation resistance, Insulation resistance -S (250 V, 500 V)

FUNCTION	Measuring range	Resolution	Accuracy
Riso	0.00 MΩ ... 19.99 MΩ	0.01 MΩ	±(3 % of reading + 2 D)
Riso-S	20.0 MΩ ... 99.9 MΩ	0.1 MΩ	± 5 % of reading
	100.0 MΩ ... 199.9 MΩ	0.1 MΩ	± 10 % of reading

**Substitute leakage current, (Isub, Isub-S)** Open circuit voltage (230Va.c.,110Va.c.),

FUNCTION	Measuring range	Resolution	Accuracy
Isub	0.00 mA ... 1.99 mA	0.01 mA	±(3 % of reading + 3 D)
Isub-S	2.00 mA ... 19.99 mA	0.01 mA	± 5 % of reading

**Differential Leakage current**

FUNCTION	Measuring range	Resolution	Accuracy
Idiff	0.000 mA ... 1.999 mA	1 μA	±(3 % of reading + 3 D)
	2.00 mA ... 19.99 mA	0.01 mA	± 5 % of reading

**PE leakage current**

FUNCTION	Measuring range	Resolution	Accuracy
Ipe	0.000 mA ... 1.999 mA	1 μA	±(3 % of reading + 3 D)
	2.00 mA ... 19.99 mA	0.01 mA	± 5 % of reading

**Touch leakage current**

FUNCTION	Measuring range	Resolution	Accuracy
Itou	0.000 mA ... 1.999 mA	1 μA	±(3 % of reading + 3 D)
	2.00 mA ... 19.99 mA	0.01 mA	± 5 % of reading

**Ipe+Ifi**

FUNCTION	Measuring range	Resolution	Accuracy
Ipe	0.000 mA ... 1.999 mA	1 μA	±(3 % of reading + 3 D)
	2.00 mA ... 19.99 mA	0.01 mA	±(5 % of reading)

**Differential leakage current**

FUNCTION	Measuring range	Resolution	Accuracy
Idiff	0.000 mA ... 1.999 mA	1 μA	±(3 % of reading + 3 D)
	2.00 mA ... 19.99 mA	0.01 mA	±(5 % of reading)

**Ifi**

FUNCTION	Measuring range	Resolution	Accuracy
Ifi	0.00 mA ... 1.99 mA	0.01 mA	±(3 % of reading + 3 D)

**FUNCTION**

FUNCTION	Measuring range	Resolution	Accuracy
Ipe+Ifi / Idiff+Ifi	0.000 mA ... 1.999 mA	1 μA	Calculated values
	2.00 mA ... 19.99 mA	0.01 mA	

**Itouch+Ifi**

**Touch leakage current**

FUNCTION	Measuring range	Resolution	Accuracy
Itou	0.000 A ... 1.999 mA	1 μA	±(3 % of reading + 3 D)
	2.00 mA ... 19.99 mA	0.01 mA	±(5 % of reading)

**Ifi**

FUNCTION	Measuring range	Resolution	Accuracy
Ifi	0.00 mA ... 1.99 mA	0.01 mA	±(3 % of reading + 3 D)

**Itouch+Ifi**

FUNCTION	Measuring range	Resolution	Accuracy
Itou+Ifi	0.000 mA ... 1.999 mA	1 μA	Calculated values
	2.00 mA ... 19.99 mA	0.01 mA	

**Power (active) @ Idiff / Ipe / Itou**

FUNCTION	Measuring range	Resolution	Accuracy
P	0 W ... 999 W	1 W	±(5 % of reading + 5 D)
	1.00 kW ... 3.70 kW	10 W	± 5 % of reading

**Power (active)**

FUNCTION	Measuring range	Resolution	Accuracy
P	0 W ... 999 W	1 W	±(5 % of reading + 5 D)
	1.00 kW ... 3.70 kW	10 W	± 5 % of reading

**Power (Apparent)**

FUNCTION	Measuring range	Resolution	Accuracy
S	0 VA ... 999 VA	1 VA	±(5 % of reading + 5 D)
	1.00 kVA ... 3.70 kVA	10 VA	± 5 % of reading

**Power (Reactive)**

FUNCTION	Measuring range	Resolution	Accuracy
Q	±(0 VAr ... 999) VAr	1 VAr	±(5 % of reading + 5 D)
	±(1.00 kVAr ... 3.70) kVAr	10 VAr	± 5 % of reading

**Power factor**

FUNCTION	Measuring range	Resolution	Accuracy
PF	0.00i ... 1.00i	0.01	±(5 % of reading + 5 D)
	0.00c ... 1.00c		

**Total Harmonic Distortion (voltage)**

FUNCTION	Measuring range	Resolution	Accuracy
THDU	0.0 % ... 99.9 %	0.1 %	±(5 % of reading + 5 D)

**Total Harmonic Distortion (current)**

FUNCTION	Measuring range	Resolution	Accuracy
THDI	0.00 A ... 16.00 A	0.01 A	±(3 % of reading + 5 D)

**Cosinus Fi**

FUNCTION	Measuring range	Resolution	Accuracy
Cos Fi	0.00i ... 1.00i	0.01	±(5 % of reading + 5 D)
	0.00c ... 1.00c		

**Current**

FUNCTION	Measuring range	Resolution	Accuracy
I	0.00 A ... 16.00 A	0.01 A	±(3 % of reading + 5 D)

**Voltage**

FUNCTION	Measuring range	Resolution	Accuracy
U	0.0 V ... 199.9 V	0.1 V	±(3 % of reading + 10 D)
	200 V ... 264 V	1 V	±3 % of reading

**(P)RCD test** (Type RCD: AC, A, F, B, B+), test current (10mA, 15mA, 30mA) / test current (100mA, 300mA with: A 1322, A 1422) Trip-out time

FUNCTION	Measuring range	Resolution	Accuracy
tΔN	0 ms ... 300 ms (999 ms*) (1/2xIΔN)	1 ms	±3 ms
	0 ms ... 300 ms (IΔN)	1 ms	±3 ms
	0 ms ... 40 ms (5xIΔN)	1 ms	±3 ms

\*According to standard AS/NZS 3017

**Trip-out current**

FUNCTION	Measuring range	Resolution	Accuracy
IΔ	0.2xIΔN ... 2.2xIΔN	0.05xIΔN	±0.1xIΔN

**Contact voltage (RCD test only)**

FUNCTION	Measuring range	Resolution	Accuracy
Uc	0.0 V ... 19.9 V	0.1 V	(-0 % / +15 %) of reading 10 D
	20.0 V ... 99.9 V	0.1 V	(-0 % / +15 %) of reading

**Additional PRCD tests** PE conductor (Type = 2 pole, 3 pole, S(3 pole))

FUNCTION	Measuring range	Resolution	Accuracy
Riso	0.00 Ω ... 19.99 Ω	0.01 Ω	±(2 % of reading + 2 D)
Riso-S	20.0 Ω ... 99.9 Ω	0.1 Ω	±3 % of reading
	100.0 Ω ... 199.9 Ω	0.1 Ω	±5 % of reading
	200 Ω ... 999 Ω	1 Ω	indicative

**PE conductor (Type = K/ Di (varistor)),** A voltage is applied between PE connections of the PRCD-K. There is a 'PASS' if PRCD trips.

**Open conductor PRCD,** Mains voltage is applied to the mains test socket. Disconnection of the L, N and PE connections is performed inside the instrument. There is a 'PASS' if the PRCD trips.

**PRCD PE probe test,** Mains voltage is applied to the mains test socket. A safe voltage sufficiently high to activate the protection circuit in the PRCD is applied to the P/S terminal.

**Polarity,** Test voltage (normal) < 50 V / Test voltage (active) mains voltage

**Clamp current,** True RMS current using 1000:1 current clamp

FUNCTION	Measuring range	Resolution	Accuracy
I	0.10 mA ... 9.99 mA	0.01 mA	±(5 % of reading + 10 digits)
I <sub>diff</sub>	10.0 mA ... 99.9 mA	0.1 mA	±(5 % of reading + 5 digits)
I <sub>pe</sub>	100 mA ... 999 mA	1 mA	±(5 % of reading + 5 digits)
	1.00 A ... 9.99 A	0.01 A	±(5 % of reading + 5 digits)
	10.0 A ... 24.9 A	0.1 A	±(5 % of reading + 5 digits)

Accuracy of current transformer is not considered.

Frequency range of current clamp is not considered.

**Flash test (1500V, 3000V),** Current a.c. (apparent)

FUNCTION	Measuring range	Resolution	Accuracy
I	0.00 mA ... 2.50 mA	0.01 mA	*(5 % of reading + 5 D)

Open circuit voltage: 1500 V, 3000 V (-0/+5%) @ 115 V, 230 V / Short circuit current: < 3.5 mA

**Riso 500 V Medical equipment**

FUNCTION	Measuring range	Resolution	Accuracy
Riso	0.00 MΩ ... 19.99 MΩ	0.01 MΩ	±(3 % of reading + 2 D)
	20.0 MΩ ... 199.9 MΩ	0.1 MΩ	±5 % of reading

**Output voltage**

FUNCTION	Measuring range	Resolution	Accuracy
U <sub>m</sub>	0 V ... 600 V	1 V	±(3 % of reading + 2 D)

**Equipment leakage current,** Medical equipment (direct, differential, alternative)

FUNCTION	Measuring range	Resolution	Accuracy
I <sub>eq</sub>	0.000 mA ... 1.999 mA	1 μA	±(3 % of reading + 3 D)
	2.00 mA ... 19.99 mA	0.01 mA	±(5 % of reading)

**Ulpe (direct, differential, alternative)**

FUNCTION	Measuring range	Resolution	Accuracy
Ulpe	0 V ... 299 V	1 V	±(2 % of reading + 2 D)

**Power (direct, differential)**

FUNCTION	Measuring range	Resolution	Accuracy
P	0 W ... 999 W	1 W	±(5 % of reading + 5 D)
	1.00 kW ... 3.70 kW	10 W	±5 % of reading

**Applied Part leakage current,** Medical equipment (direct, alternative)

FUNCTION	Measuring range	Resolution	Accuracy
I <sub>ap</sub>	0.000 mA ... 1.999 mA	1 μA	±(3 % of reading + 3 D)
	2.00 mA ... 19.99 mA	0.01 mA	±(5 % of reading)

**Uap (direct, alternative)**

FUNCTION	Measuring range	Resolution	Accuracy
Uap	0 V ... 299 V	1 V	±(2 % of reading + 2 D)

**Power (direct)**

FUNCTION	Measuring range	Resolution	Accuracy
P	0 W ... 999 W	1 W	±(5 % of reading + 5 D)
	1.00 kW ... 3.70 kW	10 W	±5 % of reading

**Touch current (Medical equipment)**

FUNCTION	Measuring range	Resolution	Accuracy
I <sub>tou</sub>	0.000 mA ... 1.999 mA	1 μA	±(3 % of reading + 3 D)
	2.00 mA ... 19.99 mA	0.01 mA	±(5 % of reading)

**Ulpe (direct)**

FUNCTION	Measuring range	Resolution	Accuracy
Ulpe	0 V ... 299 V	1 V	±(2 % of reading + 2 D)

## Power (direct)

FUNCTION	Measuring range	Resolution	Accuracy
P	0 W ... 999 W	1 W	±(5 % of reading + 5 D)
	1.00 kW ... 3.70 kW	10 W	± 5 % of reading

## Patient leakage

### Touch current

FUNCTION	Measuring range	Resolution	Accuracy
I <sub>p</sub>	0.000 mA ... 1.999 mA	1 µA	±(3 % of reading + 3 D)
	2.00 mA ... 19.99 mA	0.01 mA	±(5 % of reading)

## Power (direct)

FUNCTION	Measuring range	Resolution	Accuracy
P	0 W ... 999 W	1 W	±(5 % of reading + 5 D)
	1.00 kW ... 3.70 kW	10 W	±(5 % of reading)

## GENERAL DATA

### Mains supply

Supply voltage, frequency 110 V / 230 V AC, 50 Hz / 60 Hz  
 Max. load 10 A continuous, 16 A short duration, 1.5 kW motor  
 Mains supply overvoltage category CAT II / 300V  
 Altitude ≤ 2000 m

### Measuring categories

Instrument: Cat II / 300 V  
 Test socket: Cat II / 300 V  
 Plug test cable: Cat II / 300 V

### Protection classifications

Degree of protection IP 40 / IP 20 (mains test socket)  
 Display Colour TFT display, 4.3 inch, 480 x 272 pixels  
 Touch screen Capacitive

### Communication

Memory depends on microSD card size  
 RS232 interfaces 2  
 USB 2.0 Standard USB Type B  
 Bluetooth Class 2  
 Dimensions 310 × 130 × 250 mm  
 Weight 6.1 kg

### Operation conditions

Working temperature range: 0 °C ... +40 °C  
 Maximum relative humidity: 85 % RH (0 °C ... 40 °C), non-condensing

## STANDARDS

### Functionality

- IEC 62368-1;
- IEC 60601;
- EN 50699;
- EN 50678;
- VDE 0701-0702;
- NEN 3140;
- AS/NZS 3760;
- IET COP 5th Ed.;
- IEC/EN 62353 (VDE 0751);
- IEC/EN 60974-4 (VDE 0544-4)

## SUPPORTED INSTRUMENTS

Measuring function	MI 3360	MI 3360 25A	MI 3360 M	MI 3360 F
Visual inspections	•	•	•	•
Fuse test	•	•	•	•
Continuity // Protective earth resistance 200 mA	•	•	•	•
Continuity // Protective earth resistance 10 A, 25 A	•	•	•	•
Insulation Resistance (Riso, Riso-S),	•	•	•	•
Substitute Leakage Current, Substitute Leakage Current - S	•	•	•	•
Differential Leakage current	•	•	•	•
PE leakage current	•	•	•	•
Touch leakage current	•	•	•	•
Polarity / Active polarity test	•	•	•	•
Leakage current produced by a floating input (Itou + IFI)	•	•	•	•
Leakage current produced by a floating input (IPE + IFI)	•	•	•	•
Power (P, S, Q, PF, THDu, THDi, CosØ, I, U)	•	•	•	•
Leaks & Power (P, Itou, Idiff, S, Q, PF, THDi, THDu, CosØ, I, U)	•	•	•	•
P-RCD, (2-pole, 3-pole, K/Di (varistor), S (3-pole))	•	•	•	•
PRCD PE probe test, open conductor test, PE conductor test	•	•	•	•
RCD test, (type A, AC, B, B+, F)	•	•	•	•
Flash test, (1500 V, 3000 V)	•	•	•	•
Insulation resistance, IEC/EN 62353	•	•	•	•
Touch leakage current, IEC/EN 62353, IEC 60601	•	•	•	•
Equipment leakage (direct, differential, alternative) IEC/EN 62353	•	•	•	•
Applied part leakage (direct, alternative), IEC/EN 62353	•	•	•	•
Patient leakage (IpME), IEC/EN 62353, IEC 60601	•	•	•	•
Insulation resistance (optional A 1422), IEC/EN 60974-4	•	•	•	•
Welding circuit leakage (optional A 1422), IEC/EN 60974-4	•	•	•	•
Primary leakage (optional A 1422), IEC/EN 60974-4	•	•	•	•
No-load voltage (optional A 1422), IEC/EN 60974-4	•	•	•	•
Clamp current (with optional A 1579)	•	•	•	•
Functional inspections	•	•	•	•

### Notes:

- in combination with optional accessories,
- IEC/EN 60974-4 measurements are supported with active 3-phase adapter A 1422 only,
- Clamp current leakage measurements are supported with optional clamps A 1579

## WHY TEST PORTABLE APPLIANCES?

The need for portable and fixed appliance testing is becoming more profound, since devices such as air conditioning units, hand dryers, electrical heaters and many more similar ones have become ubiquitous. But, with frequent use come heightened risks for mechanical and electrical failures. Current legislation therefore dictates, that all devices in public use require periodic testing to determine their safety. If they are damaged, they can cause a fire or even death through electrocution.

We have prepared four different models of the MI 3360 OmegaGT XA to cover the entire spectrum of testing applications and give the user greater flexibility.



## ORDERING INFORMATION



### STANDARD SET

#### MI 3360

- Instrument MI 3360 (25A, M, F) OmegaGT XA
- Bag for accessories
- Flash test probe (MI 3360 F only)
- Crocodile clip, red (MI 3360 F only)
- Crocodile clip, black
- IEC test cable, 2 m
- Test lead, black
- Test tip, black
- Mains cable
- USB cable
- Calibration Certificate
- Short form instruction manual
- CD with instruction manual (full version)
- PC SW Metrel ES Manager BASIC\*

\* Metrel ES Manager can be downloaded free of charge from Metrel Web server.

The **MI 3360 OmegaGT XA** is intended for testing applications, that don't require a more robust testing of continuity, such as public institutions, hotels, schools etc. where used electrical devices fall mainly in I, II and III protection classes. But, despite limited functionality the instrument supports both (optional) 3-phase adapters.

The **MI 3360 25A OmegaGT XA** is intended for more demanding testing applications that encompass devices in environments such as construction sites, factories, electrical equipment rental services etc. where they are subjected to increased mechanical and electrical loads and therefore require more robust testing of continuity. Besides standard 200 mA, the instrument also offers 10 A and 25 A continuity testing.

The **MI 3360 M OmegaGT XA** is intended for testing of medical devices, since all supported tests are in accordance with IEC/EN 62353. Special emphasis is given on accurate testing of leakage current

The **MI 3360 F OmegaGT XA** is intended for testing of portable appliances after repair or maintenance with HV voltage tests with 1500 V or 3000 V for added assurance.



### KEY FEATURES

- Single tests;
- AUTOSEQUENCE®s;
- Automatic PASS/FAIL evaluation;
- Printing of test reports;
- 8 GB memory card for saving test data;
- Label printing;
- Scanning of QR and barcodes;
- Use of aMESM Android app for scanning QR codes;
- PRCD testing.



### KEY FEATURES

- Single tests;
- AUTOSEQUENCE®s;
- Automatic PASS/FAIL evaluation;
- Printing of test reports;
- 8 GB memory card for saving test data;
- Label printing (serial or Bluetooth);
- Scanning of QR and barcodes (serial or Bluetooth);
- 3-phase device testing with A 1322 / A 1422;
- 3-phase extension cord testing;
- PRCD testing;
- Welding equipment testing (A 1422) in accordance with IEC/EN 60974-4 (option).



### KEY FEATURES

- Single tests;
- AUTOSEQUENCE®s;
- Automatic PASS/FAIL evaluation;
- Printing of test reports;
- 8 GB memory card for saving test data;
- Label printing (serial or Bluetooth);
- Scanning of QR and barcodes (serial or Bluetooth);
- Testing of electrical medical devices in accordance with IEC/EN 62353.



### KEY FEATURES

- Single tests;
- AUTOSEQUENCE®s;
- Automatic PASS/FAIL evaluation;
- Printing of test reports;
- 8 GB memory card for saving test data;
- Label printing (serial printer);
- Scanning of QR and barcodes (serial scanner);
- Testing of electrical devices in service.

# PAT testers

## MI 3309 BT DeltaGT



The MI 3309 BT DeltaGT is both battery and mains powered multifunctional instrument intended to perform measurements for testing the electrical safety of portable electrical equipment. Integrated unique PRCD testing technology prevents tripping out of mains RCD during measurement. Due to dual power capability of MI 3309 it enables performing of differential leakage current test in spite of its lightweight portable design. Large graphical LCD with backlight, two PASS / FAIL LED indicators and HELP screens for each measurement make the handling of the instrument clear and simple. Up to 1500 test results with parameters can be stored in the internal memory of the instrument and then downloaded to the PC for further data handling and creation of test report. Lightweight design, pre-programmed and custom test sequences, optional barcoding, android keyboard application and RFID systems make the MI 3309 an ideal instrument for high volume professional safety testing of portable appliances.

### MEASURING FUNCTIONS

- Functional and visual inspection;
- Earth bond resistance;
- Insulation resistance;
- Insulation resistance of isolated accessible conductive parts;
- Substitute leakage current;
- Substitute leakage current of isolated accessible conductive parts;
- Differential leakage current test;
- Touch leakage test;
- RCD and portable RCD testing, type (K, S);
- Power test;
- IEC cord polarity test;
- Leakage and load currents with current clamp;
- TRMS voltage meter;
- Enhanced TRMS test.

### KEY FEATURES

- **Autosequencing:** pre-programmable VDE compatible autosequences, up to 50 custom prepared autosequences and barcode autotests speed up testing and ensure that no tests are missed.
- **Dual powered:** the instrument can operate from mains power or batteries.
- **PASS / FAIL:** large green and red lights

for additional PASS / FAIL indication placed at the sides of the LCD.

- **Fixed appliance testing:** additional inputs and optional accessories enable testing of fixed installed appliances.
- **Scan and test:** optional QR or barcoding system and PASS / FAIL QR or barcode label printing make retesting quick and simple.
- **RFID:** support for advanced RFID identification system.
- **RCD testing:** instrument enables testing of parameters of RCDs and portable RCDs.
- **Memory:** large data flash memory allows to store up to 1500 test results and parameters for further downloading to PC.
- **Built-in charger & rechargeable batteries:** instrument has a built-in charging circuit and comes complete with a set of rechargeable NiMH batteries.
- **Bluetooth:** enables communication with PC, printers, and android devices.
- **Android application:** enables advanced data management, use of smart phones camera for scanning QR and bar-code.
- **PC SW Metrel ES Manager:** included in the standard set enables downloading, viewing, printing of test results, creation of user-defined AUTOSEQUENCE<sup>®</sup>s,

and exporting of data to spreadsheet applications. Printing of PRO reports and professional export to excel is available with a PRO license.

### APPLICATION

- Professional GT safety testing;
- General GT safety testing;
- After repair GT safety testing.

### STANDARDS

#### Functionality

- EN 50699;
- EN 50678;
- VDE 0701-0702;
- NEN 3140;
- AS/NZS 3760;
- IET COP 5th Ed;
- EN 61557

#### Electromagnetic compatibility

- EN 61326

#### Safety

- EN 61010-1;
- EN 61010-031



## TECHNICAL DATA

FUNCTION	Measuring range	Resolution	Accuracy
PE continuity (200 mA)	0.00 Ω ... 19.99 Ω 20.0 Ω ... 199.9 Ω 200 Ω ... 1999 Ω	0.01 Ω 0.1 Ω 1 Ω	±(5 % of reading + 3 digits) Indication only Indication only
Insulation resistance (250 VDC, 500 VDC)	0.00 MΩ ... 19.99 MΩ 20.0 MΩ ... 49.9 MΩ 50.0 MΩ ... 199.9 MΩ	0.01 MΩ 0.1 MΩ 0.1 MΩ	±(5 % of reading + 3 digits) ±(5 % of reading + 3 digits) Indication only
Substitute leakage current (30 VAC)	0.00 mA ... 9.99 mA 10.0 mA ... 20.0 mA	0.01 mA 0.1 mA	±(5 % of reading + 3 digits) ±(5 % of reading + 3 digits)
Touch leakage current	0.00 mA ... 7.00 mA	0.01 mA	±(10 % of reading + 5 digits)
Differential leakage current	0.00 mA ... 19.99 mA	0.01 mA	±(5 % of reading + 5 digits)
Functional test: apparent power	0.00 kVA ... 4.00 kVA	0.01 kVA	±(5 % of reading + 3 digits)
RCD and portable RCD: trip-out time (IΔN= 10 mA, 15 mA, 30 mA)	0 ms ... 300 ms (½xIΔN) 0 ms ... 300 ms (IΔN) 0 ms ... 40 ms (5xIΔN)	0.1 ms 0.1 ms 0.1 ms	±3 ms ±3 ms ±1 ms
Clamp current	0.00 mA ... 9.99 mA 10.0 mA ... 99.9 mA 100 mA ... 999 mA 1.00 A ... 9.99 A 10.0 A ... 16.0 A	0.01 mA 0.1 mA 1 mA 0.01 A 0.1 A	±(5 % of reading + 10 digits) ±(5 % of reading + 5 digits) ±(5 % of reading + 5 digits) ±(5 % of reading + 5 digits) ±(5 % of reading + 5 digits)
Voltage TRMS	80 V ... 300 V	1 V	±(2 % of reading + 2 digits)
Polarity test	Test voltage < 50 VAC		
Enhanced TRMS test (Detects: No live, active neutral reversal, N fault, PE fault, Multiple fault)			
Voltage U <sub>L-N</sub> , U <sub>L-PE</sub> , U <sub>N-PE</sub>	80 V ... 300 V	1 V	±(2 % of reading + 2 digits)
R Loop	0.00 kΩ ... 1.99 kΩ	0.01 kΩ	±(10 % of reading + 5 digits)
<b>GENERAL</b>			
Power supply	6 x 1.2 V NiMH rechargeable batteries, type AA; 230 V, 50 Hz / 60 Hz		
Overvoltage category	CAT II / 300 V		
COM port	RS232, USB and Bluetooth		
Dimensions	140 x 80 x 230 mm		
Weight	1.2 kg		

### STANDARD SET

#### MI 3309

- Instrument MI 3309 BT DeltaCT
- Small soft carrying bag
- IEC cable, 2 m, 2 pcs
- Test lead, black, green, brown, 1.5 m
- Crocodile clip, black, green, brown
- Test probe, black, green, brown
- PC software Metrel ES Manager
- RS232 cable

- USB cable
- NiMH rechargeable batteries, type AA, 6 pcs
- Instruction manual on storage media
- Short instruction manual
- Calibration certificate



Picture of MI 3309 set

# PAT testers

## MI 3311 GammaGT



The MI 3311 GammaGT is a battery powered multifunctional instrument intended to perform measurements for testing the electrical safety of portable electrical equipment. Due to large graphical LCD with backlight, two PASS / FAIL LED indicators and HELP screens for each measurement the handling of the instrument is clear and simple. Up to 1500 test results with parameters can be stored in the internal memory of the instrument and then downloaded to the PC for further data handling and creation of test report. Lightweight design, pre-programmed and custom test sequences, optional barcoding, android keyboard application and RFID systems and built-in calibration unit make the MI 3311 an ideal instrument for high volume professional safety testing of portable appliances.

### MEASURING FUNCTIONS

- Continuity test with 200 mA;
- Insulation resistance;
- Insulation resistance of isolated accessible conductive parts;
- Substitute leakage current;
- Substitute leakage current of isolated accessible conductive parts;
- IEC cord polarity test;
- TRMS voltage;
- Functional and visual inspection.

### KEY FEATURES

- **Autosequencing:** pre-programmable VDE compatible autosequences, up to 50 custom prepared autosequences and barcode autotests speed up testing and ensure that no tests are missed.
- **Checkbox:** built-in calibration unit performs calibration of the instrument and the calibration results are automatically stored into instrument's memory.
- **PASS / FAIL:** large green and red lights of the LEDs indicate a PASS or FAIL evaluation of test result.
- **Scan and test:** optional QR or barcoding system and PASS / FAIL QR or barcode label printing make retesting quick and simple.

- **RFID:** support for advanced RFID identification system.
- **User friendly:** large LCD screen, two Pass / Fail LED indicators, help screens and warnings make the instrument an extremely easy to use.
- **Multi-tasking:** instrument performs continuity test, 250 V and 500 V insulation tests, substitute leakage measurement, functional and polarity tests.
- **Memory:** up to 1500 test results with measuring parameters can be stored in two level memory and downloaded to the PC with the help of PC SW PATLink PRO.
- **Built-in charger & rechargeable batteries:** instrument has a built-in charging circuit and comes complete with a set of rechargeable NiMH batteries.
- **Android application:** enables advanced data management, use of smart phones camera for scanning QR and bar-code.
- **PC SW PATLink PRO** enables downloading, viewing, printing of test results and exporting of data to spreadsheet applications.
- **PC SW PATLink PRO Plus** enables advanced analysis of test results, upload of pre-programmed custom autosequences and creation of professional test reports.

### APPLICATION

- Professional GT testing;
- General GT testing;
- After repair GT safety testing.

### STANDARDS

#### Functionality

- EN 50699;
- EN 50678;
- VDE 0701-0702;
- AS/NZS 3760;
- IET COP 5th Ed.

#### Electromagnetic compatibility

- EN 61326

#### Safety

- EN 61010-1;
- EN 61010-031

## TECHNICAL DATA

FUNCTION	Measuring range	Resolution	Accuracy
PE continuity (200 mA)	0.00 $\Omega$ ... 19.99 $\Omega$	0.01 $\Omega$	$\pm(5\%$ of reading + 3 digits)
	20.0 $\Omega$ ... 199.9 $\Omega$	0.1 $\Omega$	Indication only
	200 $\Omega$ ... 1999 $\Omega$	1 $\Omega$	Indication only
Insulation resistance (250 VDC, 500 VDC)	0.00 M $\Omega$ ... 19.99 M $\Omega$	0.01 M $\Omega$	$\pm(5\%$ of reading + 3 digits)
	20.0 M $\Omega$ ... 49.9 M $\Omega$	0.1 M $\Omega$	$\pm(5\%$ of reading + 3 digits)
	50.0 M $\Omega$ ... 199.9 M $\Omega$	0.1 M $\Omega$	Indication only
Substitute leakage current	0.00 mA ... 9.99 mA	0.01 mA	$\pm(5\%$ of reading + 3 digits)
	10.0 mA ... 20.0 mA	0.1 mA	$\pm(5\%$ of reading + 3 digits)
Voltage	0 V ... 300 V	1 V	$\pm(2\%$ of reading + 2 digits)
Polarity test	Test voltage < 50 VAC		
Power supply	6 x 1.2 V NiMH rechargeable batteries, type AA		
Overvoltage category	CAT II / 300 V		
COM port	RS232, USB and Bluetooth (optional A 1436 BT dongle)		
Dimensions	140 x 80 x 230 mm		
Weight	0.86 kg		

### STANDARD SET

#### MI 3311

- Instrument GammaGT
- Small soft carrying bag
- IEC cable, 2 m
- Test probe, black
- Test lead, black, 1.5 m
- Crocodile clip, black
- Power supply adapter
- NiMH rechargeable batteries, type AA, 6 pcs

- Instruction manual
- Calibration certificate



Picture of MI 3311 set

# Other instruments / Adapters / Accessories

## A 1322 and A 1422 Active 3-phase Adapter



Metrel's A 1322 Multifunctional test adapter is designed for troubleshooting, as well as for periodic testing on 3-phase appliances and machinery. Unique functions such as, active polarity testing, differential leakage testing and testing of 3-phase RCD's make the A 1322 Active 3-phase Adapter an ideal instrument for advanced applications. The A 1322 adapter is designed for use alongside the MI 3360 OmegaCT, enabling functional tests to be carried out on machines up to 40 A. Several test socket outlets make this instrument an ideal tester for testing industrial extension leads that may also be RCD protected. The A 1422 Multifunctional test adapter has complete support for testing of Arc Welding Equipment in accordance to EN 60974-4 and VDE 0544-4.

### KEY FEATURES

- Testing of Open-Circuit Voltage at ARC Welding Units in accordance to EN 60974-4 (A 1422 only);
- All tests on 3-phase electrical equipment can be carried out, including live leakage test, power, polarity, RCD and Active polarity;
- Simple connection to the GT/MACHINE tester with automatic detection;
- Simple test procedures, identical to single phase equipment;
- Test sequence for 3-phase tests are automatically set, based on entered test codes and input voltages;
- Built-in CEE 3-PH/32A 5 pin, CEE 3-PH/16A 5 pin and CEE 1-PH/16A 3 pin test sockets;
- Instrument comes complete with all accessories necessary for comfortable measurements and kept in a robust waterproof case.

### APPLICATION

- Testing of single and 3-phase ARC Welding equipment (A 1422 only);
- Professional 3-PH portable appliance testing;
- Professional 3-PH machine testing.

### STANDARDS

#### Functionality

- IEC/EN 60974-4 (VDE 0544-4), (A 1422 only);
- EN 50699;
- EN 50678;
- VDE 0701-0702;
- IEC/EN 60204-1 Ed.5 (VDE 0113-1);
- IEC/EN 61439-1 (VDE 0660-600-1);
- AS/NZS 3760;
- NEN 3140;
- IET COP 5th Ed

#### Electromagnetic compatibility

- EN 61326-1

#### Safety

- EN 61010-1;
- EN 61010-031

### STANDARD SET

#### A 1322

- Active 3-Phase Adapter
- Bag for accessories
- Connection cable between Adapter and Instrument
- 3-phase mains cable 16 A male / 32 A female, 5 pin, 2 m
- Test lead, 1.5 m, black
- RS232 cable
- Instruction manual, short instruction manual
- Calibration certificate

#### A 1422

- Test lead, 1.5 m, (blue, red)
- Test probe, (blue, red)



Picture of MI 1422 set

## TECHNICAL DATA

FUNCTION	Measuring range	Resolution	Accuracy
Differential leakage current (230/400 VAC or 120/208 VAC)	0.00 mA ... 9.99 mA	0.01 mA	±(5 % of reading + 5 digits)
Power / Functional test (230/400 VAC or 120/208 VAC)	0.00 kVA ... 24.29 kVA	0.01 kVA	±(5 % of reading + 5 digits)
Active power readout	0.00 kW ... 24.29 kW	0.01 kW	±(5 % of reading + 5 digits)
Reactive power readout	0.00 kVAr ... 24.29 kVAr	0.01 kVAr	±(5 % of reading + 5 digits)
Power factor readout	0.00 ... 1.00	0.01	±(5 % of reading + 5 digits)
3-phase RCD / Test current (10 mA, 15 mA, 30 mA, 100 mA, 300 mA)	0 ms ... 300 ms (½ x IΔN, IΔN)	1 ms	±3 ms
Type (AC, A, B)	0 ms ... 150 ms (2 x IΔN)	1 ms	±3 ms
	0 ms ... 40 ms (5 x IΔN)	1 ms	±3 ms
Portable RCD trip-out current readout (B type PRCD)	0.2 x IΔN ... 2.2 x IΔN	0.05 x IΔN	±0.1 x IΔN
Power supply	230 V ±10 %		
Overvoltage category	CAT II / 300 V		
Protection class	I		
COM port	RS232		
Dimensions	335 x 160 x 335 mm		
Weight	7.2 kg		
<b>A 1422 (only)</b>			
Welding circuit leakage current; Primary leakage current readout	0.00 mA ... 14.99 mA	0.01 mA	±(5 % of reading + 5 digits)
No load voltage readout; (AC peak or DC peak)	0.0 A ... 199.9 mA	0.1 A	±(5 % of reading + 5 digits)
(AC RMS)	0.0 A ... 139.9 mA	0.1 A	±(5 % of reading + 5 digits)

## KEY FEATURES

A 1422 and A 1422	MI 3360	MI 3325
Earth bond / continuity resistance 200 mA	•	•
Earth bond / continuity resistance 4A / 10A / 25 A	- / * <sup>1</sup> / * <sup>1</sup>	• / • / •
Insulation resistance	•	•
Insulation resistance – s	•	•
Substitute leakage current	•	•
Substitute leakage – s	•	•
Differential leakage current	•	•
3-phase differential leakage current	•	•
Touch leakage current	•	•
Polarity test	•	•
Active polarity test	•	•
3-phase polarity test / 3-phase active polarity test	•	•
P/RCD test, type (AC, A, B)	•	•
3-phase P/RCD test, type (AC, A, B)	•	•
Power / functional test (P, S, Q)	•	•
3-phase power / functional test (P, S, Q)	•	•
<b>A 1422 (only)</b>		
Continuity test (according to IEC/ EN 60974-4)	•	•
Insulation resistance (according to IEC/ EN 60974-4)	•	•
Leakage current (according to IEC/ EN 60974-4)	•	•
No load voltage (according to IEC/ EN 60974-4)	•	•

<sup>1</sup> 3360 25A, M, F

# Good to know

## Testing the Safety of Machines and Switchboards

### Find out more about testing safety of machines.

Typical hazardous situations related to electrical equipment are:

- failures or faults in the electrical equipment resulting in the possibility of electric shock or electrical fire;
- failures or faults in control circuits resulting in the malfunctioning of the machine;
- disturbances or disruptions in power sources as well as failures or faults in the power circuits resulting in the malfunctioning of the machine;
- loss of continuity of circuits that depends on sliding or rolling contacts, resulting in failure of a safety function;
- electrical disturbances either from outside the electrical equipment or internally generated, resulting in the malfunctioning of the machine;
- release of stored energy (either electrical or mechanical) resulting in electric shock or unexpected movement that can cause injury;
- audible noise at levels that cause health problems to persons;
- surface temperatures that can cause injury.

To verify the electrical safety of machines the appropriate measurements should be performed:

- after erection of machine;
- after installation of machine;
- after upgrading or changing of machine;
- and during periodic retests of machine.

### Verification of safety of machines

According to IEC/EN 60204, Ed.5 verification of electrical safety of machines is performed by inspection and measurements:

- Inspection that the electrical equipment complies with its technical documentation;
- Verification of protection against indirect contact by automatic disconnection;
- Insulation resistance test;
- High voltage test;
- Protection against residual voltages;
- Functional tests.

### Safety - measurements:

#### Visual test

A visual check must be carried out before each electrical safety test.

The visual inspection discloses most of faults!

A thorough visual check must be carried out before each electrical safety test.

Check of:

- Wiring connection points. Especially PE connections are important!
- Protection covers, housings
- Inscriptions and markings related to safety must be clearly readable.
- Cable layout, radiuses, isolation
- Switches, regulators, lamps, keys
- Parts subjected to wear out
- Electrical and mechanical protection devices (barriers, switches, fuses, alarms)
- Openings, filters
- Technical documentation, instructions for use available
- Installation of the appliance must be performed according to the user manuals.
- During visual inspection the measuring points for the electrical testing have to be determined too.

Check that there are no signs of:

- Damage
- Pollution, moisture, dirt that can jeopardize safety
- Corrosion
- Overheating

Verification of protection against indirect contact by automatic disconnection

This verification step is quite complex and must always be carried out in some form. The standard EC/EN 60204, Ed.5 allows simplified testing procedures regarding to the status of machine.

The status of the machine can be selected on base of:

- Condition of supplied machine (dismantled, fully assembled);
- Technical documentation (availability of existing verification report of electrical wiring of machine);
- Length of conductors after installation;
- Incoming supply characteristics - loop impedance.

How to select the appropriate machine status and test extent is described in EN/IEC 60204, Table 9.

Once the machine status and test extent are defined the limits for the Continuity and/or ZLOOP test should be defined.

### Continuity test

This test determines that the PE and equipotential connections inside the machine have proper resistance that corresponds to their length and cross-section.

Size of test current should be between at least 0.2 A and approximately 10 A. Higher currents are preferred, especially for low resistance values, i.e. larger cross sectional areas and/or lower conductor length.

Before continuity measurement test leads compensation is required to eliminate the influence of test leads resistance and instrument's internal resistance.

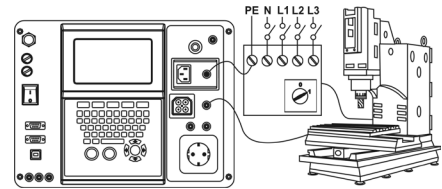

Continuity test

### Insulation resistance test

This test discloses faults caused by pollution, moisture, deterioration of insulation metal, etc.

Insulation resistance between live conductors and accessible (earthed or isolated) metal parts is checked.

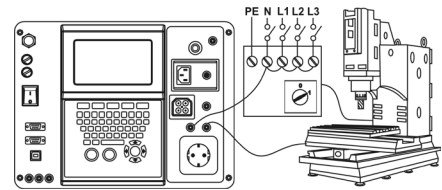

Insulation resistance test

Components and devices that are not rated to withstand the test voltage shall be disconnected during the testing.

Lower test voltages should be used for sensitive electronic equipment and surge protective devices.

### High voltage withstanding test

The HV withstanding test is used to confirm integrity of the insulation materials. During the test the insulation materials in the machine are stressed with a higher voltage than during normal operation. A powerful AC high voltage source is applied between the live/ neutral input terminals and the metal housing of the machine. The instrument trips out if the leakage current exceeds the predefined limit.

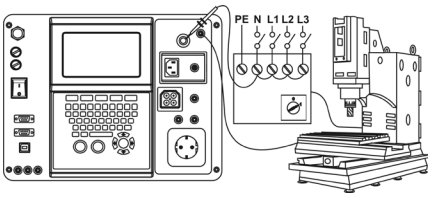

HV withstanding test

Components and devices that are not rated to withstand the test voltage shall be disconnected during the testing.

Components and devices that have been voltage tested in accordance with their product standards may be disconnected during testing.

### Loop impedance and prospective fault current

The instrument measures the impedance of the fault loop and calculates the prospective fault current. The results can be compared to limit values set on base of selected protective circuit breakers or RCDs. The measurement complies with requirements of the standard EN 61557-3.

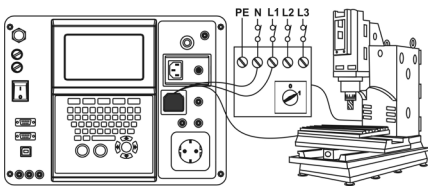

Loop impedance test

### RCD testing

Various test and measurements are required for verification of RCDs in RCD protected machines. Measurements are complies to the EN 61557-6 standard.

The following measurements and tests can be performed:

- Contact voltage,
- Trip-out time,
- Trip-out current,
- RCD autotest.

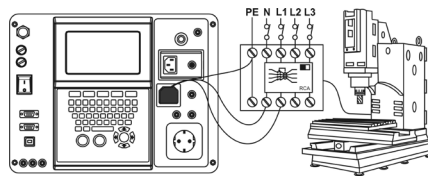

Testing of RCD in RCD protected machine

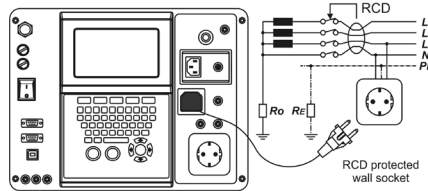

Testing of RCD in electrical installation

### Discharge Time

If large capacitors in machines are disconnected from supply there is often a remaining (residual) charge on internal machine components.

Live parts having a residual voltage greater than 60 V after the supply has been disconnected, shall be discharged to 60 V or less within a time period of 5 s after disconnection of the supply.

For plugs or similar devices with exposed conductors (for example pins) if plugged out it shall be discharged to 60 V or less within a time period of 1 s after disconnection of the supply.

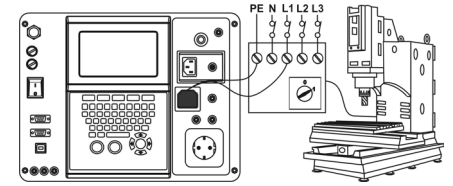

Discharge time test

### Functional test



Functional check explores if the machine is working properly.

Following items should be checked while the machine is operating:

- Temperature regulators, monitors;
- RCDs and other disconnection devices;
- Operation of functional disconnecting devices;
- Operation of switches, lamps, keys;
- Rotating parts, motors, pumps;
- Power consumption, etc.

# Machine and switchboard testers

## Selection Guide for Machines and Switchboards Testers

FEATURES	Description	MI 3394 CE MultiTesterXA	MI 3325 MultiServicerXD
			
<b>MEASUREMENTS</b>	Withstanding test 1000 VAC	•	•
	Withstanding test 1890 VAC	•	•
	Withstanding test 2200 VAC	•	•
	Withstanding test 100 ... 5100 VAC (500 VA)	•	• (250 VA)
	Withstanding test 500 ... 6000 VDC	•	•
	Continuity 200 mA	•	•
	Continuity 4 A	•	•
	Continuity 10 A	•	•
	Continuity 25 A	•	•
	Insulation resistance 50 VDC	•	•
	Insulation resistance 100 VDC	•	•
	Insulation resistance 250 VDC	•	•
	Insulation resistance 500 VDC	•	•
	Insulation resistance 1000 VDC	•	•
	Differential leakage current	•	•
	Touch leakage current	•	•
	Substitute leakage current	•	•
	PE leakage	•	•
	Discharge time	•	•
	Leakage current measurement with optional clamp		•
	RCD, (PRCD testing, optional via 3PH adapter)		•
	Line impedance		•
	Loop impedance		•
	Voltage measurement	•	•
	Frequency measurement		•
	Phase rotation indication		•
	Polarity test (IEC lead test)		•
	Functional (load) test	•	•
<b>ADDITIONAL FEATURES</b>	PASS / FAIL evaluation	•	•
	Mains supply auto check	•	•
	Graphical LCD / Colour touch LCD	• / •	• / •
	Graphical on-line help	•	•
	Backlight	•	•
	Real time clock	•	•
	QWERTY keyboard	Option	•
	Auto testing (organizer, custom autotests)	•	•
	Barcode shortcut auto testing	Option	•
	Communication ports RS232 / USB / Bluetooth / Ethernet	• / • / • / •	• / • / • / •
	"Test and tag" (barcode scanner + label printer)		•
	Data download to PC	•	•
	Project upload from PC to instrument	•	•
	Memory	up to (32 GB)	up to (32GB)
<b>STANDARD / OPTIONAL ACCESSORIES</b>	Barcode scanner / RFID / NFC	Option / Option / Option	Option / Option / Option
	Label printer	Option	Option
	Metrel ES Manager	•	•
<b>GENERAL DATA</b>	Power supply	115 V / 230 V	115 V / 230 V
	Weight	17 kg	13,3 kg / 15,1 (with accesories)
	Dimensions (mm)	435 x 155 x 292	420 x 235 x 250



# Machine and switchboard testers

## Rack mount adapter

MI 3394 CE MultiTesterXA is a premium GT tester and undoubtedly the most advanced such product on the market today, offering great versatility in a variety of testing applications. Part of that adaptability is the option to use the instrument in the standalone mode or mounted in a rack, as a part of a larger testing line. Many of our customers have expressed greater interest in the latter and have reached to us for an adaptable mounting solution, for a variety of racks.



For them, we have designed two rack mount adapters, intended to be used with RITAL square hole racks, but also suitable for a number of third-party racks. The A 1584 Rack mount adapter for MI 3394 CE MultiTesterXA enables the mounting of the said instrument, while the A 1586 Rack mount adapter for A 1460 CE Adapter ensures that this useful accessory is close to the instrument and can be easily connected at the back.

**A 1584 Rack mount adapter for MI 3394 CE MultiTesterXA**

**A 1586 Rack mount adapter for A 1460 CE Adapter**



A 1584 is a rack mount adapter for 19" rack, which is designed to hold the MI 3394 CE MultiTesterXA. This product kit includes the parts needed for complete and easy installation of the adaptor kit in RITAL square hole racks, and some third-party racks.

A 1586 is a rack mount adapter for 19" rack, which is designed to hold the A 1460 CE Adapter. This product kit includes the parts needed for complete and easy installation of the adaptor kit in RITAL square hole racks, and some third-party racks.

# Machine and switchboard testers

## MI 3394 CE MultiTesterXA



The MI 3394 CE MultiTesterXA is a portable instrument intended for electrical safety testing and CE certification of electrical appliances, machines and switchboards during the production. The instrument features in strong data management facility enabling the user to create custom auto-tests with predefined limits for pass/fail evaluation, to import predefined structure including test sequences or complete projects from PC software, plus strong memory organizer. The PC software MES-Manager enables the upload of automated test sequences, projects, downloading of test results to the PC, automatic data storage into a file, printing of test reports. Due to selected test functions, durable construction and accompanying PC SW package CE MultiTesterXA is the perfect instrument for electrical safety testing in the most demanding environments like laboratories, automated production lines or specialized workshops.

### MEASURING FUNCTIONS

- High Voltage, programmed (AC/DC).
- High Voltage, burn test (optional A 1560)
- Continuity tests.
- Insulation resistance measurement.
- Substitute leakage current.
- Differential leakage current.
- Touch leakage current.
- PE-leakage current.
- Discharge time.
- Functional test (power P/S/Q, voltage, current, cos fi, frequency, ThdU, ThdI,PF).

### KEY FEATURES

- **Data management:** the instrument features in unique user friendly data management facility and state of the art memory organizer.
- **Multiple test terminals:** different test terminals enabling the user to choose from performing single tests or

autosequences from single test socket.

- **MicroSD:** support for microSD memory card (8-GB supplied with the instrument) up to 32GB.
- **High resolution colour touch screen,** 4.3" TFT.
- **Hi-pot:** high voltage AC (5.1kV at 500VA) and DC (6kV) test.
- **Continuity:** 4 - wire continuity test with selectable test current (0.2 A, 4 A, 10A, 25A) enabling precise measurements.
- **Communication:** 4 - RS232, USB, Ethernet and Bluetooth communication ports enabling downloading, uploading and remote control over instrument.
- **Multi-system testing:** the instrument can be used on TT, TN, IT and 115 V supply systems.

### APPLICATION

- Laboratories,
- Automated production lines,
- Specialized workshops.

### STANDARDS

#### Functionality

- IEC/EN 60335;
- IEC/EN 60204-1 Ed.5 (VDE 0113-1);
- IEC/EN 61439-1 (VDE 0660-600-1);
- IEC/EN 62368-1 (IEC/EN 60950-1);
- IEC/EN 60598;
- IEC/EN 61010;
- IEC/EN 61180;
- EN 50191 (BGI 891);
- EN 50699;
- EN 50678;
- VDE 0701-0702;
- AS/NZS 3760;
- NEN 3140;
- IET COP 5th Ed

#### Electromagnetic compatibility

- EN 61326-1

#### Safety

- EN 61010-1;
- EN 61010-2-030;
- EN 61010-031;
- EN 61557

## TECHNICAL DATA

FUNCTION	Measuring range	Resolution	Accuracy
<b>HVAC, Programmable HV AC, Output voltage, 100 V - 5100 V / 10 V steps (Floating to earth)</b>			
- Test voltage (AC)	0 ... 1999 V 2.00 ... 5.99 kV	1 V 10 V	±(3 % of reading) ±(3 % of reading)
- Test current apparent	0.0 ... 99.9 mA	0.1 mA	±(3 % of reading + 3 digits)
- Capacitive	0.0 mA ... 99.9 mA	0.1 mA	Indicative
- Resistive	-99.9 mA ... 99.9 mA	0.1 mA	Indicative
- Short circuit current	> 200 mA		
- Output power	500 VAm <sub>ax</sub>		
<b>HV DC, Programmable HV DC, Output voltage, 500 V - 6000 V / 50 V steps (Floating to earth)</b>			
- Test voltage (DC)	0 ... 1999 V 2.00 ... 6.99 kV	1 V 10 V	±(3 % of reading) ±(3 % of reading)
- Test current	0.01 ... 9.99 mA	0.01 mA	±(5 % of reading + 3 digits)
<b>Discharging time</b>			
- t	0.0 ... 9.9 s	0.1 s	±(5 % of reading + 3 digits)
- Up	0 ... 550 V	1 V	±(5 % of reading + 3 digits)
<b>Continuity (0.2A, 4A, 10A, 25A)</b>			
- R	0.00 Ω ... 19.99 Ω 20.0 Ω ... 99.9 Ω 100.0 Ω ... 199.9 Ω 200 Ω ... 999 Ω	0.01 Ω 0.1 Ω 0.1 Ω 1 Ω	±(2 % of reading + 2 digits) ±(3 % of reading) ±(5 % of reading) Indicative
<b>Insulation resistance (250 V, 500 V, 1000 V), Insulation resistance - S (250 V, 500 V, 1000 V)</b>			
- Riso/Riso-s	0.00 MΩ ... 19.99 MΩ 20.0 MΩ ... 199.9 MΩ	0.01 MΩ 0.1 MΩ	±(3 % of reading + 2 digits) ±(10 % of reading)
- Output voltage	0 V ... 1200 V	1 V	±(3 % of reading + 2 digits)
<b>Insulation resistance (50 V, 100 V), Insulation resistance - S (50 V, 100 V)</b>			
- Riso/Riso-s	0.00 MΩ ... 19.99 MΩ 20.0 MΩ ... 199.9 MΩ	0.01 MΩ 0.1 MΩ	±(5 % of reading + 2 digits) ±20 % of reading
- Output voltage	0 V ... 1200 V	1 V	±(3 % of reading + 2 digits)
<b>(open circuit voltage &lt;50 V a.c.)</b>			
- I <sub>sub</sub> / I <sub>sub</sub> s	0.00 mA ... 19.99 mA	10 μA	±(5 % of reading + 3 digits)
<b>Differential Leakage current</b>			
- I <sub>diff</sub>	0.00 mA ... 19.99 mA	0.01 mA	±(3 % of reading + 5 digits)
<b>PE leakage current</b>			
- I <sub>pe</sub>	0.00 mA ... 19.99 mA	0.01 mA	±(3 % of reading + 3 digits)
<b>Touch leakage current</b>			
- I <sub>tou</sub>	0.00 mA ... 19.99 mA	0.01 mA	±(3 % of reading + 3 digits)
<b>Power</b>			
- P	0.00 W ... 19.99 W 20.0 W ... 199.9 W 200 W ... 1999 W 2.00 kW ... 3.70 kW	0.01 W 0.1 W 1 W 10 W	±(5 % of reading + 5 D) ±(5 % of reading) ±(5 % of reading) ±(5 % of reading)
- S	0.00 VA ... 19.99 VA 20.0 VA ... 199.9 VA 200 VA ... 1999 VA 2.00 kVA ... 3.70 kVA	0.01 VA 0.1 VA 1 VA 10 VA	±(5 % of reading + 10 D) ±(5 % of reading) ±(5 % of reading) ±(5 % of reading)
- Q	0.00 VAR ... 19.99 VAR 20.0 VAR ... 199.9 VAR 200 VAR ... 1999 VAR 2.00 kVAR ... 3.70 kVAR	0.01 VAR 0.1 VAR 1 VAR 10 VAR	±(5 % of reading + 10 D) ±(5 % of reading) ±(5 % of reading) ±(5 % of reading)
- PF	0.00i ... 1.00i 0.00c ... 1.00c	0.01 0.01	±(5 % of reading + 5 digits) ±(5 % of reading + 5 digits)
- THDU	0.0% ... 99.9%	0.1%	±(5 % of reading + 5 digits)
- THDI	0 mA ... 999 mA 1.00 A ... 16.00 A	1 mA 10 mA	±(5 % of reading + 5 D) ±(5 % of reading)
- Cos fi	0.00i ... 1.00i 0.00c ... 1.00c	0.01 0.01	±(5 % of reading + 5 digits) ±(5 % of reading + 5 digits)
- U	0.1 V ... 199.9 V 200 V ... 264 V	0.1 1 V	±(3 % of reading + 10 digits) ±(3 % of reading)
- I	0 mA ... 999 mA 1.00 A ... 16.00 A	1 mA 10 mA A	±(3 % of reading + 5 D) ±(3 % of reading)
Power supply	110 V / 230 V AC, 50 Hz / 60 Hz		
Overvoltage category	CAT II / 300 V, CAT II / 600 V (DISCH1 / DISCH2, only)		
Protection class	I		
HV output	5 kV a.c. / 6 kV d.c., double insulation		
COM port	4 x RS232, 1 x USB, 1 x Bluetooth		
Dimensions	435 x 292 x 155 mm		
Weight	17 kg		

**Note:** Technical specification relates to HW 3 version or higher.

### STANDARD SET

#### MI 3394 Euro set

- Instrument CE MultiTesterXA
- HV test pistol with 2 m cable, 2 pcs
- Continuity test lead, 2.5 m, 2 pcs
- Continuity test lead, red, 1.5 m, 1 pcs
- Insulation test lead, red, 2.5 m
- Insulation test lead, black, 2.5 m
- Crocodile clip, black, 2 pcs
- Crocodile clip, red, 3 pcs
- Discharge time cable
- Mains cable

- Bag for accessories
- Calibration certificate
- RS232 cable
- USB cable
- CD with instruction manual (full version)
- Metrel ES Manager BASIC Licence \*

\* Metrel ES Manager can be downloaded free of charge from Metrel Web server.



Picture of MI 3394 EU set

# Machine and switchboard testers

## MI 3394 CE MultiTesterXA CE testing and certifying

CE testing and certifying



\* Note: Personal computer is not a part of the set.

Due to the differences in testing standards globally, it has become increasingly important for manufacturers to ensure that their products are safe for the consumer and industrial markets.

### THE NEED FOR TESTING

Protecting users from potentially life threatening injuries from electrocution as a result of faulty insulation, or inadequate grounding, is of paramount importance.

The new CE MultiTesterXA, in conjunction with the CE test adaptor A 1460, provides a thorough and expeditious solution in the execution of auto tests via a single test terminal. This solution is intended for electrical safety testing and CE certification of electrical appliances, machines and switchboards during production.

Metrel has designed and developed three separate models to address the varied tests and applications required.

	MI 3394 EURO SET	MI 3394 LINE SET	MI 3394 ST SET	MI 3394 LAB SET
<b>STANDARD</b>				
MI 3394 Instrument CE MultiTesterXA	•	•	•	•
A 1460 CE Test adaptor		•		
S 2073 HV test lead 5m, without pistols			•	
A 1560 Burn Link adapter				•
A 1105 Barcode scanner		•		
A 1511 Tip Comander		•		
HV test pistol with 2 m cable, 2 pcs	•			•
Continuity test lead, 2.5 m, 2 pcs	•	•	•	•
Continuity test lead, red, 1.5 m, 1pcs	•	•	•	•
Insulation test lead, red, 2.5 m	•	•	•	•
Insulation test lead, black, 2.5 m	•	•	•	•
Crocodile clip, black, 3 pcs	•	•	•	•
Crocodile clip, red, 2 pcs	•	•	•	•
Discharge time cable	•	•	•	•
Mains cable	•	•	•	•
Bag for accessories	•	•	•	•
Calibration certificate	•	•	•	•
RS232 cable	•	•	•	•
USB cable	•	•	•	•
A 1521 USB isolator		•		
CD with instruction manual (full version)	•	•	•	•
Metrel ES Manager BASIC Licence	•	•	•	•
<b>OPTIONAL</b>				
A 1496 2-LED signal tower lamp HV	•	•	•	•
A 1497 4-LED signal tower lamp	•	•	•	•
A 1495 Remote pedal	•	•	•	•

The **LINE set** is defined to be most ideal for automated testing of equipment on production lines. The MI 3394, in combination with the A 1460, provides the user full hands free operation in executing the tests. Metrel ES manager software enables configuration of test procedures (sequences) which are uploaded to the tester and used for automated testing. Test sequences can be started via a remote pedal or tip commander. Predefined test limits are used for the evaluation of PASS/FAIL status, with results being automatically stored on the microSD memory card. Unique ID of tested equipment can be added via barcode scanner during the test procedure.



#### KEY FEATURES

- Custom defined automatic test sequences via PCSW Metrel ES Manager,
- Execution of test sequences via A 1460 CE test adapter,
- Hands free operation,
- PASS/FAIL and warning lamps,
- Programmable inputs and outputs,
- Programmable messages, pauses and several different flow commands,
- Execution of all tests via single test terminal.
- Built-in microSD memory card (8GB supplied with the instrument).
- A 1460 has a built-in robust fuse housing, enabling countless change of protective fuses.
- A 1460 has a built-in parallel test terminals to the test socket (enabling the user to plug in custom made test terminal).
- Test commander has a built in LED torch lamp and PASS/FAIL status LED lamps.
- Execution of test commands via test commander test button.
- Bar-code scanner enabling identification of barcode labeled appliances.

The **STANDARD set** is defined based on typical requirements for smaller production. The instrument's intuitive touch screen display enables easy selection of required tests and test limits for fast test execution. Test limits are used for PASS/FAIL evaluation, results of the test can be stored under different memory structure levels. The set enables execution of all available single tests. Optionally, the user can also use barcode scanner for entering the equipment's ID.



#### KEY FEATURES

- Creation of structure with dedicated tests,
- PASS/FAIL evaluation of test results,
- Execution of all single tests,
- Programmable High Voltage (AC + DC) test,
- 4-wire continuity test.

The **LAB set** is defined to cover requirements that are most often required in test laboratories or R&D department's for type testing. One of the most important test to be carried out is the dielectric withstand test which can be destructive or non-destructive. The MI 3394 supports the execution of both. To execute the destructive withstanding test, the Burn Link Adapter (A 1560) must be used. The set includes also a set of professional HV test pistols for carrying out AC + DC HV tests safely. The rest of the available tests can be carried out via different test terminals. All the tested data can be stored on an 8GB micro SD card.



#### KEY FEATURES

- Execution of all single tests,
- Programmable High Voltage (AC + DC) test,
- HV burn test, with limited breakdown current,
- 4-wire continuity test,
- PASS/FAIL evaluation of test results.
- Execution of auto-test via test terminals of the instrument.
- Built-in microSD memory card (8GB supplied with the instrument).

# Machine and switchboard testers

## MI 3325 MultiServicerXD



The MI 3325 MultiServicerXD is a top-of-the-line multi-functional instrument covering diverse industrial applications, where robustness and reliability are a must. The new platform integrated in the MI 3325 features in support for colour touch screen technology, advanced memory organizer including large SD-card storage media and state of the art AUTOSEQUENCE<sup>®</sup>s.

### MEASURING FUNCTIONS

- Continuity (2W & 4W), 0.2A, 4A, 10A, 25A + Voltage drop @ 10A;
- HV AC, HV AC programmable 100V - 5100V;
- Insulation Resistance (Riso, Riso-S) 50V, 100V, 250V, 500V, 1000V (dc);
- Sub-Leakage Current, (Isub, Isub-S) 110V a.c., 230V a.c.;
- Z loop - Fault loop impedance and prospective fault current (Ipsc, Ulpe, Uc(P));
- Zs rcd - Fault loop impedance and prospective fault current in system with RCD (Ipsc, pe, Uc(P));
- Z line - Line impedance and prospective short-circuit current (Ipsc, Ul<sub>n</sub>);
- Functional test (power P/S/Q, voltage, current, cos fi, frequency, ThdU, ThdI, PF);
- Touch leakage current; RCD testing (RCD Uc, RCD t, RCD I);
- Differential Leakage current;
- PE leakage current;
- Polarity;
- Clamp current;
- Voltage, Frequency, Phase rotation;
- Varistor test;
- Voltage Drop;
- Discharging time.

### KEY FEATURES

- **High resolution colour touch screen**, 4.3" TFT.
- **Double manipulation:** keyboard and touch screen enable the user to control the instrument in any manner they like.

- **Pre-defined AUTOSEQUENCE<sup>®</sup>s:** enable the user simple and quick execution of test sequence for the chosen device.
- **Support for RCD testing:** all instruments support testing of A, AC, B, B+ and F RCDs.
- **Testing of welding equipment** (only in combination with A 1422): MI 3325 support testing of welding equipment in accordance with IEC/EN 60974-4.
- Functional inspections.
- Visual inspections.
- Custom inspections (visual and functional).
- **Built-in help screens** for referencing on site.
- **Built-in fuse tables** for automatic evaluation of the line / loop impedance result.
- **Monitoring** of all 3 voltages in real-time.
- **Hi-pot:** high voltage AC (5.1kV @ 250VA).
- Continuity: 4 - wire continuity test with selectable test current (0.2 A, 4 A, 10A, 25A) enabling precise measurements.
- **Communication:** 4 - RS232, USB, Ethernet and Bluetooth communication ports enabling downloading, uploading and remote control over instrument.
- **Multi-system testing:** the instrument can be used on TT, TN, IT and 115 V supply systems.
- Automated RCD testing procedure (RCD AUTO).
- Automated Impedance testing procedure (Z AUTO).
- Measurement filtering according to the selected area group.
- **Large memory:** support for microSD memory cards, 8 GB card already integrated in the instrument, although

that can be expanded to 32 GB.

- **PC SW Metrel ES Manager:** enables creation of test structures, user-defined AUTOSEQUENCE<sup>®</sup>s, professional test reports and data transfer for archiving.

### APPLICATION

- Factory machinery safety testing,
- Industrial safety testing,
- Periodic safety testing,
- Production line safety testing,
- Portable appliances safety testing,
- Arc welding equipment safety testing,
- Switchgear, control gear, safety testing.

### STANDARDS

#### Functionality:

- IEC/EN 60204-1 Ed.5 (VDE 0113-1), IEC/EN 61439-1 (VDE 0660-600-1), IEC/EN 60974-4 (VDE 0544-4), (A 1422 only), IEC/EN 62368-1 (IEC/EN 60950-1), EN 61557;
- IEC/EN 61180, EN 50191 (BGI 891), EN 50699, EN 50678, VDE 0701-0702, AS/NZS 3760, NEN 3140, IET COP 5th Ed

#### Safety:

- EN 61010-1, EN 61010-2-030, EN 61010-031, EN 61010-2-032, EN 61557

#### EMC

- EN 61326-1

TECHNICAL DATA

FUNCTION	Measuring range	Resolution	Accuracy
<b>Continuity 2W, 4W, test current (0.2A, 4A, 10A, 25A)</b>			
- R	0.00 Ω ... 19.99 Ω 20.0 Ω ... 99.9 Ω 100.0 Ω ... 999.9 Ω 200 Ω ... 999 Ω	0.01 Ω 0.1 Ω 0.1 Ω 1 Ω	±(2 % of reading + 2 D) ±(3 % of reading) ±(5 % of reading) Indicative
<b>Voltage drop (Iout = 10 A)</b>			
- ΔU	0.00 Ω ... 19.99 Ω 20.0 Ω ... 99.9 Ω	0.01 Ω 0.1 Ω	±(2 % of reading + 5 D) ±(3 % of reading)
<b>HVAC, Programmable HV AC, Output voltage, 100 V - 5100 V / 10 V steps (Floating to earth)</b>			
- Voltage (AC)	0 V ... 1999 V 2.00 kV ... 5.99 kV	1 V 10 V	±(3 % of reading) ±(3 % of reading)
- Current, apparent	0.0 mA ... 49.9 mA** / 99.9 mA*	0.1 mA	±(3 % of reading + 3 D)
- Current, resistive	0.0 mA ... 49.9 mA** / 99.9 mA*	0.1 mA	Indicative
- Current capacitive	-49.9 mA ... 49.9 mA** -99.9 mA ... 99.9 mA*	0.1 mA 0.1 mA	Indicative Indicative
- Short circuit current	> 200 mA		
- Output power	250 VA max		
<b>Insulation resistance (250 V, 500 V), Insulation resistance - S (250 V, 500 V), Riso - PAT / Riso - Welding</b>			
- Riso/Riso-s	0.08 MΩ ... 19.99 MΩ 20.0 MΩ ... 99.9 MΩ 100.0 MΩ ... 999.9 MΩ	0.01 MΩ 0.1 MΩ 0.1 MΩ	±(3 % of reading + 2 D) ±(5 % of reading) ±(10 % of reading)
- Output voltage	0 V ... 600 V	1 V	±(3 % of reading + 2 D)
<b>Insulation resistance (500 V and 1000 V) ISO installation</b>			
- Riso	0.15 MΩ ... 19.99 MΩ 20.0 MΩ ... 199.9 MΩ 200.0 MΩ ... 999 MΩ	0.01 MΩ 0.1 MΩ 1 MΩ	±(5 % of reading + 3 D) ±(5 % of reading) ±(10 % of reading)
- Output voltage	0 V ... 1200 V	1 V	±(3 % of reading + 3 D)
<b>Insulation resistance (50 V, 100 V and 250 V) ISO Installation</b>			
- Riso	0.15 MΩ ... 19.99 MΩ 20.0 MΩ ... 99.9 MΩ 100.0 MΩ ... 999.9 MΩ	0.01 MΩ 0.1 MΩ 0.1 MΩ	±(5 % of reading + 2 D) ±(10 % of reading) ±(20 % of reading)
- Output voltage	0 V ... 300 V	1 V	±(3 % of reading + 3 D)
Measuring range according to EN 61557	0.15 MOhm ... 999 MOhm		
<b>Substitute leakage (Isub, Isub-S), open circuit voltage, 110 V a.c., 230 V a.c.</b>			
- Isub	0.02 mA ... 1.99 mA	0.01 mA	±(3 % of reading + 3 D)
- Isub s	2.00 mA ... 19.99 mA	0.01 mA	±(5 % of reading)
<b>Differential Leakage current</b>			
- Idiff	0.010 mA ... 1.999 mA 2.00 mA ... 19.99 mA	0.001 mA 0.01 mA	±(3 % of reading + 10 D) ±(5 % of reading)
<b>PE leakage current</b>			
- Ipe	0.010 mA ... 1.999 mA 2.00 mA ... 19.99 mA	0.001 mA 0.01 mA	±(3 % of reading + 3 D) ±(5 % of reading)
<b>Touch leakage current</b>			
- Itou	0.010 mA ... 1.999 mA 2.00 mA ... 19.99 mA	0.001 mA 0.01 mA	±(3 % of reading + 3 D) ±(5 % of reading)
Operating range (acc. to EN 61557-16)	0.010 mA ..... 19.99 mA		
<b>Power</b>			
- P (active)	0.00 W ... 19.99 W 20.0 W ... 199.9 W 200 W ... 1999 W 2.00 kW ... 3.70 kW	0.01 W 0.1 W 1 W 10 W	±(5 % of reading + 5 D) ±(5 % of reading) ±(5 % of reading) ±(5 % of reading)
- S (apparent)	0.00 VA ... 19.99 VA 20.0 VA ... 199.9 VA 200 VA ... 1999 VA 2.00 kVA ... 3.70 kVA	0.01 VA 0.1 VA 1 VA 10 VA	±(5 % of reading + 10 D) ±(5 % of reading) ±(5 % of reading) ±(5 % of reading)
- Q (reactive)	0.00 VAR ... 19.99 VAR 20.0 VAR ... 199.9 VAR 200 VAR ... 1999 VAR 2.00 kVAR ... 3.70 kVAR	0.01 VAR 0.1 VAR 1 VAR 10 VAR	±(5 % of reading + 10 D) ±(5 % of reading) ±(5 % of reading) ±(5 % of reading)
- PF	0.00 i ... 1.00 i 0.00 c ... 1.00 c	0.01 0.01	±(5 % of reading + 5 D) ±(5 % of reading + 5 D)
- THDU	0.0 % ... 99.9 %	0.1%	±(5 % of reading + 5 D)
- THDI	0 mA ... 999 mA 1.00 A ... 16.00 A	1 mA 0.01 A	±(5 % of reading + 5 D) ±(5 % of reading)
- Cos Phi	0.00i ... 1.00i 0.00c ... 1.00c	0.01 0.01	±(5 % of reading + 5 D)
- U	0.1 V ... 199.9 V 200 V ... 264 V	0.1 1 V	±(3 % of reading + 10 D) ±(3 % of reading)
- I	0 mA ... 999 mA 1.00 A ... 16.00 A	1 mA 0.01 A	±(3 % of reading + 5 D) ±(3 % of reading)

<b>RCD testing / current shape AC, A, F, B, B+ / RCD type (non-delayed, S time-delayed, PRCD, PRCD-K, PRCD-S)</b>			
- I $\Delta$ - Trip-out current	0.2 xI $\Delta$ N ... 1.1 xI $\Delta$ N (AC type); 0.2 xI $\Delta$ N ... 1.5 xI $\Delta$ N (A type, I $\Delta$ N $\geq$ 30 mA); 0.2 xI $\Delta$ N ... 2.2 xI $\Delta$ N (A type, I $\Delta$ N<30 mA); 0.2 xI $\Delta$ N ... 2.2 xI $\Delta$ N (B type)	0.05 xI $\Delta$ N	$\pm$ 0.1 xI $\Delta$ N
- U $c$ - Contact voltage	0.0 V ... 19.9 V 20.0 V ... 99.9 V	0.1 V	(-0 % / +15 %) of reading $\pm$ 10 D (-0 % / +15 %) of reading
<b>UC I<math>\Delta</math>N - Contact voltage</b>			
- U $c$ I $\Delta$	0.0 V ... 19.9 V 20.0 V ... 99.9 V	0.1 V	(-0 % / +15 %) of reading $\pm$ 10 D (-0 % / +15 %) of reading
- t $\Delta$ N - Trip-out time	0.0 ms ... 40.0 ms 0.0 ms ... max. time* * For max. time refer to user manual.	0.1 ms	$\pm$ 1 ms $\pm$ 3 ms
<b>Trip out time</b>			
- t I $\Delta$	0 ms ... 300 ms	1 ms	$\pm$ 3 ms
<b>Polarity, Test voltage (normal) &lt; 50 V / Test voltage (active) mains voltage</b>			
Power consumption of tested device during the active test.....< 25 VA			
<b>Clamp current (True RMS current using 1000:1 current clamp)</b>			
- I	0.00 mA ... 9.99 mA	0.01 mA	$\pm$ (5 % of reading + 10 D)
- I $_{diff}$	10.0 mA ... 99.9 mA	0.1 mA	$\pm$ (5 % of reading + 5 D)
- I $_{pe}$	100 mA ... 999 mA	1 mA	
	1.00 A ... 9.99 A	0.01 A	
	10.0 A ... 24.9 A	0.1 A	
Accuracy of current transformer is not considered.			
Frequency range of current clamp is not considered.			
<b>Voltage (Online terminal voltage monitor (10 ... 550 V) + Phase rotation)</b>			
- TRMS (14 ... 500 Hz) U $_{ln}$ , U $_{lpe}$ , U $_{npe}$ , U $_{1pe}$ , U $_{2pe}$ , U $_{12}$ , U $_{13}$ , U $_{23}$	0 V ... 550 V	1 V	$\pm$ (2 % of reading + 2 D)
- Frequency	0.00 Hz ... 9.99 Hz 10.0 Hz ... 499.9 Hz	0.01 Hz 0.1 Hz	$\pm$ (0.2 % of reading + 1 D)
<b>Varistor test</b>			
- DC voltage	0 V ... 1000 V	1 V	$\pm$ (3 % of reading + 3 D)
- AC voltage	0 V ... 625 V	1 V	Consider accuracy of DC voltage
<b>R low - Resistance of earth connection and equipotential bonding</b>			
- R	0.16 $\Omega$ ... 19.99 $\Omega$ 20.0 $\Omega$ ... 199.9 $\Omega$ 200 $\Omega$ ... 1999 $\Omega$	0.01 $\Omega$ 0.1 $\Omega$ 1 $\Omega$	$\pm$ (3 % of reading + 3 D) $\pm$ (5 % of reading) $\pm$ (5 % of reading)
Measuring range according to EN 61557	0.16 $\Omega$ ... 1999 $\Omega$		
- R+,R-	0.0 $\Omega$ ... 199.9 $\Omega$ 200 $\Omega$ ... 1999 $\Omega$	0.1 $\Omega$ 1 $\Omega$	$\pm$ (5 % of reading + 5 D) $\pm$ (5 % of reading + 5 D)
Open circuit voltage	6.5 Vdc ... 18 Vdc		
Measuring current	min. 200 mA into load resistance of 2 $\Omega$		
Test lead compensation	up to 5 $\Omega$		
<b>Impedance Z loop, (L-PE, Test current @ 230V ... 20A (10ms))</b>			
- Z - Fault loop impedance	0.00 $\Omega$ ... 9.99 $\Omega$ 10.0 $\Omega$ ... 99.9 $\Omega$ 100 $\Omega$ ... 999 $\Omega$ 1.00 k $\Omega$ ... 9.99 k $\Omega$	0.01 $\Omega$ 0.1 $\Omega$ 1 $\Omega$ 10 $\Omega$	$\pm$ (5 % of reading + 5 D) $\pm$ (10 % of reading) $\pm$ (10 % of reading) $\pm$ (10 % of reading)
Measuring range according to EN 61557	0.12 $\Omega$ ... 9.99 k $\Omega$		
<b>Impedance Zs rcd, L-PE</b>			
- Z - Zs Rcd	0.00 $\Omega$ ... 9.99 $\Omega$ 10.0 $\Omega$ ... 99.9 $\Omega$ 100 $\Omega$ ... 999 $\Omega$ 1.00 k $\Omega$ ... 9.99 k $\Omega$	0.01 $\Omega$ 0.1 $\Omega$ 1 $\Omega$ 10 $\Omega$	$\pm$ (5 % of reading + 12 D) $\pm$ (5 % of reading + 12 D) $\pm$ (10 % of reading) $\pm$ (10 % of reading)
Measuring range according to EN 61557 is	0.46 Ohm ... 9.99 kOhm for I $_{test}$ = normal and 0.48 Ohm ... 9.99 kOhm for I $_{test}$ = low.		
- I $_{psc}$ - Prospective fault current	0.00 A ... 9.99 A 10.0 A ... 99.9 A 100 A ... 999 A 1.00 kA ... 9.99 kA 10.0 kA ... 23.0 kA	0.01 A 0.1 A 1 A 10 A 100 A	Consider accuracy of fault loop resistance measurement
- U $_{lpe}$ - Voltage	0 V ... 550 V 20.0 V ... 99.9 V* * for Z - Zs Rcd function	1 V 0.1 V	$\pm$ (2 % of reading + 2 D)
<b>Impedance Z line (L-L, L-N, Test current @ 230V ... 20A (10ms))</b>			
- Z Line impedance	0.12 $\Omega$ ... 9.99 $\Omega$ 10.0 $\Omega$ ... 99.9 $\Omega$ 100 $\Omega$ ... 999 $\Omega$ 1.00 k $\Omega$ ... 9.99 k $\Omega$	0.01 $\Omega$ 0.1 $\Omega$ 1 $\Omega$ 10 $\Omega$	$\pm$ (5 % of reading + 5 D) $\pm$ (5 % of reading + 5 D) $\pm$ 10 % of reading $\pm$ 10 % of reading



- Ipsc - Prospective fault current	0.00 A ... 0.99 A 1.0 A ... 99.9 A 100 A ... 999 A 1.00 kA ... 99.99 kA 100 kA ... 199 kA	0.01 A 0.1 A 1 A 10 A 1000 A	Consider accuracy of line resistance measurement
- UIn - Voltage	0 V ... 550 V	1 V	±(2 % of reading + 2 D)
<b>Voltage Drop (Zref 0.00 Ω ... 19.99 Ω, Test current @ 230V ... 20A (10ms))</b>			
- dU - Voltage drop	0.0 % ... 99.9 %	0.1 %	Consider accuracy of line resistance measurement (s)
<b>Discharging time</b>			
- t - Discharging time	0.0 s ... 10.0 s	0.1 s	±(5 % of reading + 2 D)
- Up - Peak voltage	0 V ... 550 V	1 V	±(5 % of reading + 3 D)
Threshold voltage: 34 V, 60 V, 120 V			
<b>General data</b>			
Power supply	110 V / 230 V AC, 50 Hz / 60 Hz		
Max. power consumption	300 VA (without load on mains test socket)		
Max. load	10 A continuous, 16 A short duration, 1.5 kW motor		
<b>Measuring categories</b>			
Mains test socket, IEC test socket	CAT II / 300V		
TC1 test socket, (C1,C2,P1,P2,P)	CAT III / 300 V		
<b>Protection classification</b>			
Degree of protection	IP 54 (Closed case), IP 40 (Open case), IP 20 (Mains socket)		
<b>Communication</b>			
Memory	Depends on microSD card size		
RS232 interfaces	Two DB9 ports (RS 232-1(PC), RS 232-2)		
INPUTS/OUTPUTS	24 Vmax (DB9 connector, 2X)		
USB 2.0	Standard USB Type B		
Bluetooth	Class 2		
Ethernet	Dynamic IP (DHCP)		
Display	Colour TFT display, 4.3 inch, 480 x 272 pixels		
Dimensions	420 x 325 x 180 mm / 420 x 325 x 250 mm (with accessories)		
Weight	13.3 kg / 15.1 kg (with accessories)		

#### STANDARD SET

##### MI 3325

- Instrument MultiServicerXD
- HV test lead with test probe
- HV test lead with crocodile
- Mains cable
- IEC test cable
- Residual voltage test cable
- Plug test cable
- 3-wire test lead, 3 m
- Continuity test lead, 2.5 m, 2 pcs
- Test lead, red, 1.5 m
- Test probe, 4 pcs (black, red, green, blue)

- Crocodile clip, green
- Crocodile clip, blue
- Crocodile clip, black, 3 pcs
- Crocodile clip, red, 3 pcs
- Calibration certificate
- RS232 cable
- USB cable
- CD with instruction manual (full version)
- PC SW Metrel ES Manager BASIC \*
- Protective bag for accessories \*\*

\* Metrel ES Manager can be downloaded free of charge from Metrel Web server.

\*\* Mounted on the case



Picture of MI 3325 set

# Good to know

## Safety of medical equipment

Medical equipment comes with an important difference to other types of appliances. The applications can bring the voltage to a patient's body for therapeutic or monitoring reasons. This fact creates additional requirements for safety of both the patient and the operator. Safety testing is prescribed by two specialised standards.

### IEC 60601

The standard group IEC 60601 is the industry standard. It is used in development, type testing and periodical testing. It is extremely thorough, which makes the process slow and requires highly specialised testing equipment. The main focus of the tests are the leakage currents.

### IEC 62353

The second standard is newer and only describes periodic testing and testing after service. The focus is on tests that can be performed in any location without moving the equipment. The number of measurements is lower while the testing speed is higher. The selection of tests differs from the IEC 60601.



### Classification of equipment

The classification of equipment only differs in some details.

#### By protection class

Class III falls under Class I or Class II when charging. Being powered from SELV is not considered inherently safe.

#### Classification of equipment (by protection classes)

CLASS	I	II	III
Marking	No	□	III
Supply cord	Three pole (L, N, PE)	Two pole (L, N)	Two pole
Examples			

#### By applied part types

Applied parts are the parts of the equipment that come in direct electrical contact with the patient.

**Type B:** provides protection against electric shock in terms of leakage and auxiliary currents.



**Type F:** provides higher protection than type B by isolating the parts from the rest of the equipment. Also called BF.



**Type CF:** provides the highest protection against electrical damage and is meant for cardiac use.



#### State definitions

**Normal condition:** the equipment works as intended. Electrical signal flows through its designed paths. Any insufficient insulation is considered a short circuit. Any raised resistance on the earth bond is considered open circuit.

**Single fault condition:** one of the following cases is true: any unintended short or open circuit on insulation, air clearance, creepage distance, or in parallel to the mentioned; unintended open circuit on earth connection; interruption of any power-carrying conductors; movement of any components.

#### Relevant parts of medical equipment:

1. Enclosure.
2. Signal input/output.
3. Functional earth connection.
4. Patient connections (applied parts) type B and type F.
5. Non-earthed accessible parts (NEP).
6. Earthed accessible parts (EP).
7. Mains part.
8. Supply cord (L, N, PE connections).

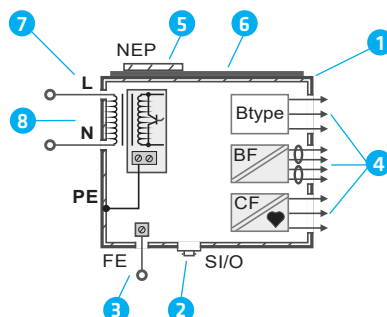

#### Periodic test by IEC 62353:

- Visual check is standardised.
- Protective earth resistance with 200 mA, 10 A or 25 A.
- Insulation test (if needed, between different possible points on the instrument) with 500 V.
- Equipment leakage (alternative, direct or differential methods).
- Touch leakage.
- Applied parts leakage (alternative or direct method).
- Functional test. Metrel provides a custom checklist.

#### Periodic test by IEC 60601

The number and selection of tests used in periodic testing is defined by the manufacturer. Below is the general overview of all possibilities. A general test is usually only done during type testing.

The leakage tests are performed under all of the following conditions:

- Normal and single fault.
- Energised stand by and fully operating.
- Normal and reversed supply polarity.
- 110% of the rated voltage and highest rated frequency.

Measurements are done from, to and between all accessible parts, including applied parts.

#### Standard tests

- Visual inspection. There is no standard inspection, but the manufacturers prepare requirements in the service manual. Metrel enables creation of custom checklists.
- Protective earth resistance with 200 mA or up to 25 A.
- Earth leakage test: the aggregate leakage current in the protective earth conductor.

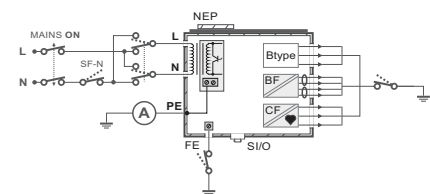

Class I Earth leakage measurement

- Earth leakage test: the aggregate leakage current in the protective earth conductor.

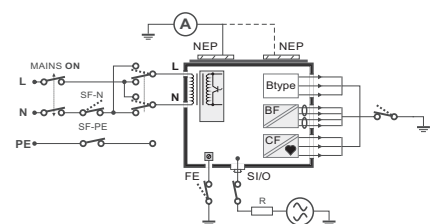

Touch current measurement

Patient leakage currents:

- To earth: current between each patient connection and protective earth.

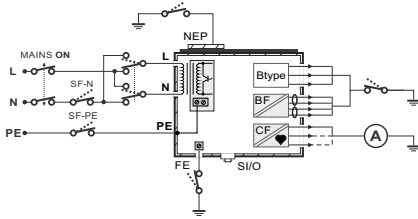

Class I patient leakage to earth measurement

- Vext on AP: in case of floating applied parts, perform additional measurement with external voltage on them.

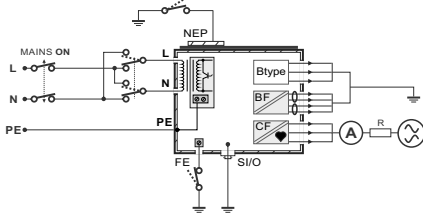

Class I patient leakage with external voltage on applied parts

- Vext on SIO: in case of non-earthed connection to SIO, additional measurements are done with external voltage on them.

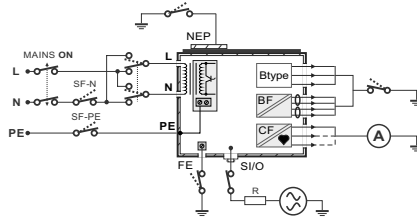

Class I patient leakage with external voltage on SIO port

- Vext on NEP: external voltage on NEP. Measure leakage between patient connections and protective earth during external voltage on NEP.

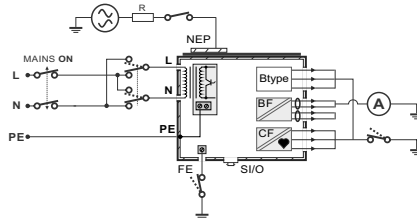

Class I patient leakage with external voltage on non-earthed parts

- Patient auxiliary current: measurement between each of the patient connections and the rest of them.

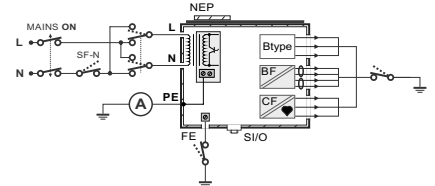

Patient auxiliary current measurement on Class II device

- Total patient leakage current measures of the same type applied parts connected together, in all scenarios mentioned in Patient leakage.

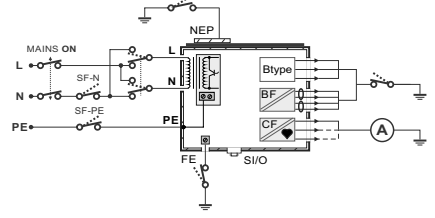



Total patient leakage to earth on Class II device



# Medical testers

## Selection Guide for Medical testers

FEATURES	Description	MI 6601 MediTest <b>NEW</b>	MI 3360 M OmegaPAT XA
			
<b>STANDARDS</b>	IEC/EN 62353	•	•
	ANS/NZS 3551	•	
	IEC 60601-1 2nd edition	•	
	IEC 60601-1 2nd, 3rd edition	•	
<b>MEASUREMENTS</b>	<b>Protective Earth resistance</b>	>200 mA ac and 25 A ac	>200 mA ac, 10 A ac, 25 A ac
	Range	0 ... 999 Ω	0 ... 999 Ω
	Earth bond test mode	Socket, probe	Socket, probe
	<b>Insulation resistance test / Mains to protective Earth</b>	250 V, 500 V	250 V, 500 V
	Range	0 ... 199.9 MΩ	0 ... 199.9 MΩ
	ISO test mode	LN_PE, LN_NEP, LN_AP, AP_PE, AP_NEP	Riso, Riso-S
	<b>Equipment current / power</b>	•	•
	Range	0 A ... 25 A	0 A ... 25 A
	Duty cycle	0 ... 25 A, continuous	0 ... 25 A, continuous
	Test mode	AC TRMS	AC TRMS
	<b>Leakage current tests</b>	•	•
	Range	0 μA ... 19.99 mA	1 μA ... 19.99 mA
	Patient leakage current test mode	AC + DC (True-RMS), AC only, DC only	AC + DC (True-RMS), AC only, DC only
	Frequency response / accuracy (DC to 1MHz)	As required by IEC 60601	As required by IEC 60601
	Earth leakage IEC 60601	•	
	Touch leakage IEC 60601	•	
	Patient leakage IEC 60601 F-Type	•	
	Total patient leakage	•	
	Patient auxiliary leakage	•	
	Vext on applied parts leakage	•	
	Equipment alternative leakage IEC 62353	•	•
	Equipment direct leakage IEC 62353	•	•
	Applied part alternative IEC 62353	•	•
	Applied part direct IEC 62353	•	•
	Equipment differential leakage IEC 62353	•	•
	Point - to - point leakage	•	
	lec lead test	•	•
	Mains voltage test mode	0 V ... 300 V AC RMS (touch, point-to-point, L-N)	0 V ... 300 V AC RMS L-N
<b>ADDITIONAL FEATURES</b>	Test modes	Automated / Manual	Automated / Manual
	Mains voltage measurement	Touch, point to point, L-N	Mains
	PE test current	200 mAac, 25 Aac	200 mA, 10 A, 25 A
	Patient auxiliary leakage load selection	Any 1 to all	
	Applied parts connections	10 x Applied parts	1 (connect all)
	Data entry options	Touchscreen, onscreen keyboard, physical keyboard, barcode scanner, bluetooth	Touchscreen, onscreen keyboard, physical keyboard, barcode scanner, bluetooth
	Printer port	Bluetooth or wired printer	Bluetooth or wired printer
	Point to point measurements	Voltage	
	Connectivity	Bluetooth, RS232, USB, Ethernet	Bluetooth, RS232, USB
	PC SW included in standard set	•	
	Power cord	Removable	Removable
	Operating temperature	0 °C to +40 °C	0 °C to +40 °C
	Storage temperature	-10 °C to +60 °C	-10 °C to +60 °C
	Operating humidity	max 85 %	max 85 %
	Altitude	2000 m	2000 m
	Environmental protection	IP 40 case open / IP 65 case closed	IP 40 / IP 20 mains test socket
	Warranty	2 years	2 years
	Power supply	110/230 V ±10%, 50/60 Hz	110/230 V ±10%, 50/60 Hz
	Battery		1 min
<b>GENERAL DATA</b>	Dimensions (W x D x H)	420 x 180 x 330 mm	310 x 130 x 250 mm
	Weight	8.1 Kg	6.1 kg

# Medical testers

## MI 6601 MediTest

NEW

Appliance / Machine / Switchboard Safety



The MI 6601 MediTest is a new Metrel tester for testing the electrical safety of medical equipment in the accordance with the IEC/EN 60601 standard in any stage of medical equipment life cycle. It is accurate enough for development work, offers detailed measurements for type testing, it can be embedded into the production line and is portable enough for recurrent testing in accordance with IEC/EN 60601 or IEC/EN 62353. In addition it can help with diagnosing problems in service departments or can be used for troubleshooting in the field.

The MI 6601 MediTest can be used as stand-alone tester without a PC or laptop in the field. For office and laboratory use, the tester can work in combination with Metrel Medical Electrical Safety Manager (MMESM). It supports creation and execution of test sequences in accordance with IEC/EN 60601 and asset management. Reports are created with integrated online services Metrel Cloud Reports and Metrel Cloud Storage. Compliance with IEC/EN 60601 is a widely accepted benchmark and a requirement for commercialisation of electrical medical equipment around the world. In Metrel we believe that our new MI 6601 MediTest is the fastest and easiest-to-use electrical safety compliance tester on the market, which entirely covers prescribed standard test procedures, without any compromises or simplifications.

### MEASUREMENTS AND INSPECTIONS

- **PE resistance** with 200 mA<sub>Ac</sub> and 25 A<sub>Ac</sub>;
- **Insulation resistance** with test voltage 250 V<sub>Dc</sub> or 500 V<sub>Dc</sub>.
- All test configurations acc. to IEC/EN 62353 are supported;
- **Leakage current** measurements with 1 µA resolution;
- AC, DC and TRMS value of leakage currents;
- **All leakage current** measurements as defined in **IEC/EN 60601 standard** (patient, auxiliary, earth, touch);
- **All leakage current** measurements as defined

- in **IEC/EN 62353** (equipment and applied part; alternative, direct, differential method);
- Measurements according to **portable appliance standards EN 50678 and EN 50699**;
- Point-to-point, Touch and Mains **voltage tests**;
- **Equipment power**;
- **IEC lead test**;
- Pre-set or configurable **visual and functional inspections**.

### KEY FEATURES

- The most complete IEC 60601 tester on the market;
- 10 universal configurable connections. They can be configured as applied parts, non-earthed parts, earthed parts;
- Dedicated test ports for connection to functional earthing and signal I/O connections;
- All possible configurations acc. to the IEC/EN 60601 and IEC/EN 62353 standards;
- Tests can be run on the instrument directly or via PC;
- Fully automatic test flow with Auto Sequences®;
- Tests and limits are automatically set acc. to the set configuration of medical equipment;
- Test sequences are optimized for fastest work flow;
- Supports measuring by standards IEC/EN 60601 (2nd and 3rd editions), IEC/EN 62353, ANS/NZS 3551, EN 50678 and EN 50669;
- Use of single tests to diagnose problems easily;

- High current for testing continuity of PE connections: up to 25 A;
- AC and DC values of Patient leakage and Patient auxiliary current;
- Communication over Bluetooth, USB, RS232 and Ethernet;
- Input data in any desired way: touchscreen, barcode/QR code scanner, wireless keyboard, PC SW;
- Optional printers or NFC writer for creating labels and tags;
- New PC SW Metrel Medical Electrical Safety Manager in standard set;
- IP 40 case open, IP 65 case closed;
- Carrying case and bag for accessories;
- Standard warranty 2 years.

### APPLICATIONS

- Safety of medical equipment during development, production, service, periodic verification.
- Troubleshooting medical equipment.
- Safety of standard portable appliances.
- Troubleshooting portable devices.

TECHNICAL DATA

FUNCTION		MEASURING RANGE	RESOLUTION	ACCURACY
<b>Continuity / Protective earth resistance</b>				
<sup>1</sup> Continuity	R	0.00 Ω ... 19.99 Ω 20.0 Ω ... 99.9 Ω 100.0 Ω ... 199.9 Ω 200 Ω ... 999 Ω	0.01 Ω 0.1 Ω 0.1 Ω 1 Ω	±(2 % of reading + 2 D) ±3 % of reading ±5 % of reading Indicative
<b>Insulation Resistance (Riso, Riso-S)</b>				
<sup>2</sup> Insulation resistance, Insulation resistance -S (250 V, 500 V)	Riso Riso-S	0.00 MΩ ... 19.99 MΩ 20.0 MΩ ... 99.9 MΩ 100.0 MΩ ... 199.9 MΩ	0.01 Ω 0.1 Ω 0.1 Ω	±(3 % of reading + 2 D) ±5 % of reading ±10 % of reading
<sup>2</sup> Output voltage	Um	0 V ... 600 V	1 V	±(3 % of reading + 2 D)
<b>Sub-Leakage Current, Substitute Leakage Current - S</b>				
<sup>3</sup> Substitute leakage current, Substitute leakage current - S	Isub Isub-S	0.00 mA ... 1.99 mA 2.00 mA ... 19.99 mA	0.01 mA 0.01 mA	±(3 % of reading + 3 D) ±(5 % of reading)
<b>Differential Leakage current</b>				
<sup>4</sup> Differential leakage current	Idiff	0.000 mA ... 1.999 mA 2.00 mA ... 19.99 mA	1 μA 0.01 mA	±(3 % of reading + 3 D) ±(5 % of reading)
<sup>4</sup> Power (active)	P	0 W ... 999 W 1.00 kW ... 3.70 kW	1 W 10 W	±(5 % of reading + 5 D) ±5 % of reading
<b>PE leakage current</b>				
<sup>5</sup> PE leakage current	Ipe	0.000 mA ... 1.999 mA 2.00 mA ... 19.99 mA	1 μA 0.01 mA	±(3 % of reading + 3 D) ±(5 % of reading)
<sup>5</sup> Power (active)	P	0 W ... 999 W 1.00 kW ... 3.70 kW	1 W 10 W	±(5 % of reading + 5 D) ±5 % of reading
<b>Touch leakage current</b>				
<sup>6</sup> Touch leakage current	Ipe	0.000 mA ... 1.999 mA 2.00 mA ... 19.99 mA	1 μA 0.01 mA	±(3 % of reading + 3 D) ±(5 % of reading)
<sup>6</sup> Power (active)	P	0 W ... 999 W 1.00 kW ... 3.70 kW	1 W 10 W	±(5 % of reading + 5 D) ±5 % of reading
<b>Power</b>				
Power (active)	P	0 W ... 999 W 1.00 kW ... 3.70 kW	1 W 10 W	±(5 % of reading + 5 D) ±5 % of reading
Power (apparent)	S	0 VA ... 999 VA 1.00 kVA ... 3.70 kVA	1 VA 10 VA	±(5 % of reading + 5 D) ±5 % of reading
Power (reactive)	Q	±(0 VAr ... 999) VAr ±(1.00 kVAr ... 3.70) kVAr	1 VAr 10 VAr	±(5 % of reading + 5 D) ±5 % of reading
Power factor	PF	0.00i ... 1.00i 0.00c ... 1.00c	0.01	±(5 % of reading + 5 D)
Total Harmonic Distortion (voltage)	THDU	0.0 % ... 99.9 %	0.1 %	±(5 % of reading + 5 D)
Total Harmonic Distortion (current)	THDI	0.00 A ... 16.00 A	0.01 A	±(3 % of reading + 5 D)
Cosinus fi	Cos fi	0.00i ... 1.00i 0.00c ... 1.00c	0.01 0.01 A	±(5 % of reading + 5 D)
Current	I	0.00 A ... 16.00 A	0.01 A	±(3 % of reading + 5 D)
Voltage	U	0.0 V ... 199.9 V 200 V ... 264 V	0.1 V 1 V	±(3 % of reading + 10 D) ±3 % of reading
<b>Leak's &amp; Power</b>				
<sup>7</sup> Power (active)	P	0 W ... 999 W 1.00 kW ... 3.70 kW	1 W 10 W	±(5 % of reading + 5 D) ±5 % of reading
<sup>7</sup> Touch leakage current	Itou	0.000 mA ... 1.999 mA 2.00 mA ... 19.99 mA	1 μA 0.01 mA	±(3 % of reading + 3 D) ±(5 % of reading)
Differential leakage current	Idiff	0.000 mA ... 1.999 mA 2.00 mA ... 19.99 mA	1 μA 0.01 mA	±(3 % of reading + 3 D) ±(5 % of reading)
Power (apparent)	S	0 VA ... 999 VA 1.00 kVA ... 3.70 kVA	1 VA 10 VA	±(5 % of reading + 5 D) ±5 % of reading
Power (reactive)	Q	~(0 VAr ... 999) VAr ~(1.00 kVAr ... 3.70) kVAr	1 VAr 10 VAr	±(5 % of reading + 5 D) ±5 % of reading
Power factor	PF	0.00i ... 1.00i 0.00c ... 1.00c	0.01	±(5 % of reading + 5 D)
Total Harmonic Distortion (voltage)	THDU	0.0 % ... 99.9 %	0.1 %	±(5 % of reading + 5 D)
Total Harmonic Distortion (current)	THDI	0.00 A ... 16.00 A	0.01 A	±(3 % of reading + 5 D)
Cosinus fi	Cos fi	0.00i ... 1.00i 0.00c ... 1.00c	0.01 0.01 A	±(5 % of reading + 5 D)
Current	I	0.00 A ... 16.00 A	0.1 V	±(3 % of reading + 5 D)
Voltage	U	0.0 V ... 199.9 V 200 V ... 264 V	1 V	±(3 % of reading + 10 D) ±3 % of reading

<b>Clamp current</b>				
<sup>8</sup> Clamp current	ldiff	0.10 mA ... 9.99 mA	0.01 mA	±(5 % of reading + 10 digits)
	lp	10.0 mA ... 99.9 mA	0.1 mA	±(5 % of reading + 5 digits)
		100 mA ... 999 mA	1 mA	±(5 % of reading + 5 digits)
		1.00 A ... 9.99 A	0.01 A	±(5 % of reading + 5 digits)
		10.0 A ... 24.9 A	0.1 A	±(5 % of reading + 5 digits)
<b>Insulation Resistance</b> Riso LN-PE, LN-NEP, LN-AP, AP-PE, AP-NEP				
Riso	Riso	0.00 MΩ ... 19.99 MΩ	0.01 MΩ	±(3 % of reading + 2 D)
		20.0 MΩ ... 199.9 MΩ	0.1 MΩ	±5 % of reading
<sup>9</sup> Output voltage	Um	0 V ... 600 V	1 V	±(3 % of reading + 2 D)
<b>Equipment leakage (alternative, direct, differential)</b>				
<sup>10</sup> Equipment leakage current (direct, differential, alternative)	Ieq	0.000 mA ... 1.999 mA	1 μA	±(3 % of reading + 3 D)
<sup>10</sup> Uipe (direct, differential, alternative)	Uipe	2.00 mA ... 19.99 mA	0.01 mA	±(5 % of reading)
<sup>10</sup> Power (direct, differential)	P	0 V ... 299 V	1 V	±(2 % of reading + 2 D)
		0 W ... 999 W	1 W	±(5 % of reading + 5 D)
		1.00 kW ... 3.70 kW	10 W	±5 % of reading
<b>Applied Part leakage (alternative, direct)</b>				
<sup>11</sup> Applied Part leakage current (direct, alternative)	lap	0.000 mA ... 1.999 mA	1 μA	±(3 % of reading + 3 D)
		2.00 mA ... 19.99 mA	0.01 mA	±(5 % of reading)
<sup>11</sup> Uap (direct, alternative)	Uap	0 V ... 299 V	1 V	±(2 % of reading + 2 D)
<sup>11</sup> Power (direct)	P	0 W ... 999 W	1 W	±(5 % of reading + 5 D)
		1.00 kW ... 3.70 kW	10 W	±5 % of reading
<b>Touch current, Touch current NEP -NEP</b>				
Touch current	ltou	0.000 mA ... 1.999 mA	1 μA	±(3 % of reading + 3 D)
		2.00 mA ... 19.99 mA	0.01 mA	±(5 % of reading)
<b>Patient leakage, Total patient leakage</b>				
VEXT on SIO	lpVextSIO, ItVextSIO	0.000 mA ... 1.999 mA	1 μA	±(3 % of reading + 3 D)
		2.00 mA ... 19.99 mA	0.01 mA	±(5 % of reading)
VEXT on NEP	lpVextNEP, ItVextSIO	0.000 mA ... 1.999 mA	1 μA	±(3 % of reading + 3 D)
		2.00 mA ... 19.99 mA	0.01 mA	±(5 % of reading)
VEXT on AP	lpVextAP, ItVextAP	0.000 mA ... 1.999 mA	1 μA	±(3 % of reading + 3 D)
		2.00 mA ... 19.99 mA	0.01 mA	±(5 % of reading)
To earth	lpTOEARTH, ItTOEARTH	0.000 mA ... 1.999 mA	1 μA	±(3 % of reading + 3 D)
		2.00 mA ... 19.99 mA	0.01 mA	±(5 % of reading)
<sup>1</sup> Operating range (acc. to EN 61557-4)		0.08 Ω ... 199.9 Ω		
Test currents		0.2 A, 25 A		
Current source (at nominal mains voltage, use of standard accessories)		> 0.2 A at R < 2 Ω / > 25 A into short circuit at 230 V < 9 VAC		
Open circuit voltage				
<sup>2</sup> Operating range (acc. to EN 61557-2)		0.08 MW ... 199.9 (999) MW		
Nominal voltages Un		250 V, 500 V (-0 %, +10 %)		
Short circuit current		max. 2.0 mA		
<sup>3</sup> Operating range (acc. to EN 61557-16)		0.02 mA ... 19.99 mA		
Open circuit voltage		230 VAC, 110 VAC		
Current calculated to mains supply voltage (110 V or 230 V) is displayed.				
<sup>4</sup> Operating range (acc. to EN 61557-16)		0.010 mA ... 19.99 mA		
Influence of load current		< 0.02 mA/A		
<sup>5</sup> Operating range (acc. to EN 61557-16)		0.010 mA ... 19.99 mA		
<sup>6</sup> Operating range (acc. to EN 61557-16)		0.010 mA ... 19.99 mA		
<sup>7</sup> Operating range (acc. to EN 61557-16)		0.010 mA ... 19.99 mA		
<sup>8</sup> True RMS current using 1000:1 current clamp. Accuracy of current transformer is not considered. Frequency range of current clamp is not considered.				
<sup>9</sup> Operating range (acc. to EN 61557-2)		0.08 MW ... 199.9 (999) MW		
Nominal voltages Un		500 V (-0 %, +10 %)		
Short circuit current		max. 2.0 mA		
<sup>10</sup> Operating range direct and differential method (acc. to EN 61557-16)		0.010 mA ... 19.99 mA		
Operating range alternative method (acc. to EN 61557-16)		0.020 mA ... 19.99 mA		
Influence of load current (differential method)		< 0.02 mA/A		
<sup>11</sup> Operating range direct method (acc. to EN 61557-16)		0.010 mA ... 19.99 mA		

## TECHNICAL SPECIFICATION

### Mains supply

Supply voltage, frequency	110 V / 230 V AC, 50 Hz / 60 Hz
Supply voltage tolerance	±10 %
Max. power consumption	300 VA (without load on test socket)
Max. load	10 A continuous, 16 A short duration, 1.5 kW motor
Mains supply overvoltage category	CAT II / 300V
Altitude	≤ 2000 m

### Measuring categories

Instrument	CAT II / 300 V
Test socket	CAT II / 300 V
Plug test cable	CAT II / 300 V
Altitude	≤ 2000 m

### Leakage current measurements

Measuring device (MD)	Comply to IEC 60601 and IEC 61557-16 requirements
Measurement type	AC, DC or True RMS, as per IEC 60601, IEC 61557-16 requirements



<b>Protection classifications</b>	
Power supply	Class I
Pollution degree	2
Degree of protection	IP 40
Case	IP 20 (mains test socket) Shock proof plastic / portable
<b>Display</b>	
Display	Colour TFT display, 4.3 inch, 480 x 272 pixels
Touch screen	Capacitive
<b>Communication</b>	
Memory	Depends on microSD card size
RS-232 interfaces	2
USB 2.0	Standard USB Type B
Bluetooth	Class 2
Ethernet	Dynamic IP (DHCP)
<b>Reference conditions</b>	
Reference temperature range	15 °C ... 35 °C
Reference humidity range	35 % ... 65 % RH
<b>Operation conditions</b>	
Working temperature range	0 °C ... +40 °C
Maximum relative humidity	85 % RH (0 °C ... 40 °C), non-condensing
<b>Storage conditions</b>	
Temperature range	-10 °C ... +60 °C
Maximum relative humidity	90 % RH (-10 °C ... +40 °C) 80 % RH (40 °C ... 60 °C)
<b>Fuses</b>	
Fuses	2 x T 16 A / 250 V, 32 mm x 6.3 mm / 1500 A
<b>General</b>	
Dimensions (w×h×d)	420 mm x 180 mm x 330 mm
Weight	8.1 kg

\*Accuracies apply for 1 year in reference conditions. Temperature coefficient outside these limits is 0.2 % of measured value per °C plus 1 digit, otherwise noted.

## STANDARD SET

### Standard set MI 6601

- Instrument MI 6601 MediTest
- A 1080 Mains cable
- A 1758 Test lead, black, 1 m
- A 1759 Test lead, brown, 1 m
- A 1760 Test lead, green, 1 m
- A 1761 Test lead, yellow, 1 m
- A 1762 Test lead, violet, 1 m
- A 1014 Test probe, black
- A 1298 Test probe, brown

- A 1062 Test probe, green
- A 1013 Crocodile clip, black, 2pcs
- A 1297 Crocodile clip, brown
- A 1309 Crocodile clip, green
- A 1546 Crocodile clip, yellow
- A 1727 USB cable
- A 1500 Bag for accessories
- Metrel Medical ES Manager\*

\* Metrel Medical ES Manager can be downloaded free of charge from Metrel Web server.



Picture of MI 6601 set

# Good to know

## End-of-line safety testing in production

### End-of-line safety testing in production

Ensure the electrical safety of your manufactured equipment and safety of your staff with Metrel end-of-line safety testing systems.

Safety testing of electrical devices in production process requires special care for the operator, since the test procedures include application of dangerous test voltages, which translates to a heightened probability of electric shock.

Almost all electrical equipment needs to be inspected and tested after production, as part of end-of-line testing. Metrel has developed MI 3394 CE MultiTesterXS product solution, safety modules and accessories to fully cover the European standard EN 50191 for erection and operation of test equipment.

### Safety systems

Metrel offer 4 standard safety systems for erection of test installation, enabling the provision of the electrical safety testing according to EN 50191.

### Test stations with automatic protection against direct contact



*S 2109 safety system with RFID sensor*

*S 2110 safety system with light barrier sensor*

When we talk about electrical safety testing the first things that come to mind are usually electrical installation safety testing and machine and portable appliance safety testing (PAT). Simultaneously forgetting where electrical safety really starts – on the production floor. More specifically, at the end of the production line, before the various electrical and electronic devices and components are packed and shipped to customers. This type of testing is, not arbitrarily, called end-of-line (EOL) testing. There is some overlap between “regular” electrical safety testing (of appliances and machines) using portable testing equipment and that done at the end of the production line using integrated solutions, however differences are far more pronounced. Industry 4.0 is upon us and few if any standalone testing equipment supports easy integration in new or existing production/testing line and seamless communication with other elements of the line, primarily the central control unit, using standard protocols.

Not wanting to be left out and recognizing limitations of our existing products for integration (in production/testing lines), we have decided to expand our product portfolio with a dedicated tester, testing modules and accessories for EOL testing. Together they constitute a comprehensive testing suite for electrical safety testing of equipment in accordance with the EN 50191 standard and can be combined in any manner to best suit the customer’s needs. Part of the suite is also a versatile software package that includes a SDK for easy integration with third-party software and subsequent smooth data flow from and between all elements of the suite, starting with the central testing unit that “runs the show”.

### One central unit

Having unified control of various testing stages can be challenging and there are several design approaches on how to do this, some more customizable and therefore flexible than others. We have chosen the one-central-unit-many-accessories approach. In other words, one main testing unit that controls the various testing modules and connected accessories and acts as communication relay between them and a central control unit for the entire line. The MI 3394 CE MultiTesterXA platform was chosen as the most appropriate and served as the basis for a dedicated EOL testing unit MI 3394 CE MultiTesterXS.

In comparison with the base model, the MI 3394 CE MultiTesterXS has an additional communication port for connecting with selected module(s) and a revamped safety mechanism for current limitation in selected HV tests and many more new features. Features that enable reliable control of the various sub-units that comprise the testing system (as set up by the customer) and offer user-defined automatization of selected testing procedures, all the while maintaining the highest safety level as prescribed by the standard (EN 50191). However, the question of acceptable safety is ultimately in the realm of the users and predicated on their choice of the testing module, how it is integrated in the production/testing line and used accessories.

### Easy customization

Testing modules or safety modules as we like to call them, are devices that act as both as connection hubs for the various testing accessories and safety equipment (emergency switches, light curtains etc.) and protective gateways between the user and the testing line. This latter function is provided by independently monitoring safety mechanism preventing direct contact with live voltage, and limiting output current in selected HV tests. Any fault (direct contact or testing current surge) triggers virtually immediate disconnection from the rest of the testing/production line, thus providing the highest protection grade (PLe or SIL3).

There are four distinct safety modules, differing in supported safety equipment, but offering identical flexibility in regard to testing accessories (i.e. which accessories can be connected to them). Safety equipment includes RFID sensors (open/closed testing cage’s door), light curtains,

### Test station without automatic protection against direct contact



*S 2111 safety system with Two hand control*

### Test station where requirements from EN 50191 can be omitted.



*S 2115 safety system with current limitation  $I_{test} < 3mA$*

two hand control protective device and a current limiting device – all in combination with emergency START/STOP switches.

Modules as well as safety equipment can be easily installed in existing or new testing lines and come with bolt holes for that purpose, or in our prefabricated testing cages and cabinets. We offer two single chamber test cages and as well as one large rack cabinet with mounting adapters for the MI 3394 CE MultiTesterXS and one additional accessory. All are one size fits all – customized testing cage by a third party integrator may be needed if the customer has more specific requirements. Same goes for the software component of the suite.

#### Seamless integration

No modern EOL testing solution is complete without a versatile software and ours is no exception. We envisioned Metrel ES Manager (MESM) to fill this role since it offers a myriad of features that enable automatization of entire testing procedures, making them safer for the user and more time-efficient. Nevertheless, the customer likely already has dedicated software for the entire line and would like to integrate our EOL – as easy as possible. This is where the SDK (part of the software package) comes into play. The SDK enables customers to use their existing production line/testing software for communication with the various components of our testing suite without the need for proprietary software (MESM).

The customers therefore have virtually free hands when it comes to using our testing suite for their needs. They can buy the entire suite and use it as it is or purchase individual components and utilize them as they see fit.

*For more information visit the Metrel website or ask for a quotation at your local distributor.*

# End-of-line safety testing in production

## MI 3394 CE MultiTesterXS



The MI 3394 CE MultiTesterXS is a multi-functional test instrument that includes all features of CE MultiTester XA instrument. The instrument is intended for electrical equipment safety testing. It can be used in all kinds of applications such as type testing, in-line testing, maintenance testing, testing after repair, periodic (recurrent) testing. The XS (Extended Safety) version of the instrument is specially designed to support connection of different safety modules for independent control of dangerous measuring circuits and/or limitation of output current. Supported safety modules make the instrument safer to use (up to Ple or SIL 3) and consequently ready for integration into production lines.

### MEASURING FUNCTIONS

- High Voltage, programmed (AC/DC).
- High Voltage, burn test (optional A 1560)
- Continuity tests.
- Insulation resistance measurement.
- Substitute leakage current.
- Differential leakage current.
- Touch leakage current.
- PE-leakage current.
- Discharge time.
- Functional test (power P/S/Q, voltage, current, cos fi, frequency, ThdU, ThdI, PF).

### KEY FEATURES

- Control of measuring circuits with help of Safety sets;
- Support for CE Switch 5 kV;
- Limitation of current in HV test to safe level in combination with Safety sets;
- Perfectly suited for use in working places according to EN 50191.

### APPLICATION

- Testing of electrical equipment;
- CE marking and routine testing after production.

### STANDARDS

#### Functionality

- EN 50191 (BGI 891);
- IEC/EN 60335;
- IEC/EN 60204-1 Ed.5 (VDE 0113-1);
- IEC/EN 61439-1 (VDE 0660-600-1);
- IEC/EN 62368-1 (IEC/EN 60950-1);
- IEC/EN 60598;
- IEC/EN 61010;
- IEC/EN 61180;
- EN 50699;
- EN 50678;
- VDE 0701-0702;
- AS/NZS 3760;
- NEN 3140;
- IET COP 5th Ed

#### Electromagnetic compatibility

- EN 61326-1

#### Safety

- EN 61010-1;
- EN 61010-2-030;
- EN 61010-031;
- EN 61557













# Selection Guide for GT Accessories

Photo	Part number	Description	Target application	MI 3360	MI 3309 BT	MI 3311	A 1322	A 1422	MI 3394	MI 601	MI 3325
	A 1322	Active 3-phase Adapter	A 1322 Multifunctional test adapter is designed for troubleshooting, as well as for periodic testing on 3-phase appliances and machinery.	•							•
	A 1422	Active 3-phase Adapter Plus	A 1422 Multifunctional test adapter is designed for troubleshooting, as well as for periodic testing on 3-phase appliances, machinery, and ARC welding equipment.	•							•
	MI 3144	Euro Z 800V	The Euro Z 800 V AC and DC impedance adapter with up to 800 V test voltage and 16 ... 420 Hz range, high current dR300 A with flex clamps, 4-wire, U step-contact and ELR trip-out testing.								•
	MI 3143	Euro Z 440V	The Euro Z 440 V AC impedance adapter with up to 440 V test voltage and 16 ... 420 Hz range, high current dR300 A , 4-wire and U step-contact testing.								•
	A 1632	eMobility Analyser	The A 1632 is used for diagnostic, electrical safety and functional testing of Type 2 EVSE and Mode 2 and Mode 3 EV charging cables.								•
	A 1584	Rack mount adapter for MI 3394 CE MultiTesterXA	A 1584 is a rack mount adapter for 19" rack, which is designed to hold the MI 3394 CE MultiTesterXA. This product kit includes the parts needed for complete and easy installation of the adaptor kit in RITAL square hole racks, and some third-party racks.							•	
	A 1585	Rack mount adapter for MI 3325 MultiServicerXD	A 1585 is a rack mount adapter for 19" rack, which is designed to hold the MI 3325 MultiServicerXD. This product kit includes the parts needed for complete and easy installation of the adaptor kit in RITAL square hole racks, and some third-party racks.								•
	A 1586	Rack mount adapter for A 1460 CE Adapter	A 1586 is a rack mount adapter for 19" rack, which is designed to hold the A 1460 CE Adapter. This product kit includes the parts needed for complete and easy installation of the adaptor kit in RITAL square hole racks, and some third-party racks.							• <sup>1</sup>	• <sup>1</sup>
	A 1460 XA	CE Adapter	Provides a thorough and expeditious solution in the execution of auto tests via a single test terminal, A 1511 2M5 included in set.								•
	A 1460 XD	CE Adapter									
	A 1560	Burn Link adapter	For performing insulation breakdown test with limited breakdown current "30~mA".							•	
	A 1207	Three phase adapter	The 3-phase adapter for substitute leakage current, insulation resistance and continuity measurements on electric loads equipped with 16A and 32A CEE 3P sockets.	•	•	•				•	•
	A 1556	Medical adapter	Medical multi-probe adapter for testing all applied parts with a single measurement. Adapter is designed to be used in combination with MI 3360 M model.	•							











• Option

<sup>1</sup> A 1460 CE Adapter only

<sup>2</sup> MI 3360 25A, MI 3360 M, MI 3360 F only

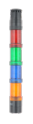











Photo	Part number	Description	Target application	MI 3360	MI 3309 BT	MI 3311	A 1322	A 1422	MI 3394	MI 1601	MI 3325
	A 1789	Single Fault Condition Adapter	Single Fault Condition Adapter is designed to simulate abnormal operating conditions or single-fault conditions (SFC). Product standards as EN 60601 and EN 62368 demand testing leakage currents in single fault condition.	•							
	A 1610	Continuity test adapter	Continuity test adapter enabling point-to-point testing of earth continuity with 10 & 25 A test current.	• <sup>2</sup>					•		•
	A 1474	115 V test adapter	115 V test adapter for testing 115 V appliances, (available for UK/NZ/AUS models only).	•							
	A 1316	3-phase adapter (16 A CEE-Schuko)	3-phase adapter for testing 3-phase appliances.	•	•	•			•		•
	A 1317	3-phase adapter (32 A CEE-Schuko)	3-phase adapter for testing 3-phase appliances.	•	•	•			•		•
	A 1110	Three phase adapter	3-phase test adapter for installation safety testing on 3-phase sockets type 16 A 3CEE.								•
	A 1111 A 1215	Three phase adapter with switch	3-phase adapter with selection switch for installation safety testing on 3-phase sockets type 16 A 3CEE. The adapter allows seamless switching between measurements.								•
	A 1373	3-phase mains cable / adapter 32 A male / 32 A female, 5 pin, 2 m	3-phase test adapter, for testing of 3 phase extension leads in combination with A 1322 / Active 3-phase Adapter. 3-phase power supply cable for A 1322 / Active 3-phase adapter.				•	•			
	A 1375	1-phase mains cable / adapter 32 A / 16 A Schuko, 3 pin, 2 m	1-phase Power supply cable for A 1322 / Active 3-phase adapter.				•	•			
	A 1376	3-phase adapter 16 A male / 16 A female, 5 pin, 2 m	3-phase test adapter, for testing of 3 phase extension leads in combination with A 1322 / Active 3-phase Adapter.				•	•			
	A 1394	1-phase adapter 16 A male / 16 A female, 3 pin, 2 m	1-phase test adapter for, testing of 1 phase extension leads in combination with A 1322 / Active 3-phase Adapter.				•	•			

• Option











Photo	Part number	Description	Target application	MI 3360	MI 3309 BT	MI 3311	A 1322	A 1422	MI 3394	MI 1601	MI 3325
	A 1418	1-phase adapter 16 A, 3 pin female / 16 A Schuko male, 2 m	1-phase test adapter for, testing of 1 phase extension leads in combination with A 1322 / Active 3-phase Adapter.				•	•			
	A 1419	1-phase adapter 16 A, 3 pin male / 16 A Schuko female, 2 m	1-phase test adapter for, testing of 1 phase extension leads in combination with A 1322 / Active 3-phase Adapter.				•	•			
	A 1423	Adapter for welding equipment, 25mm <sup>2</sup> /CX0020	Test adapter for measuring leakage current, insulation, earth bond and no load voltage on ARC welding equipment.					•			
	A 1424	Adapter for welding equipment, 50mm <sup>2</sup> /CX0022							•		
	A 1425	Adapter for welding equipment, 70mm <sup>2</sup> /CX0025							•		
	A 1472	Leakage current clamp	Current clamp with high resolution for accurate leakage current measurements.		•						
	A 1579	Leakage current clamp	Current clamp with high resolution for accurate leakage current measurements.	•						•	•
	A 1388	Adapter Schuko / Schuko	Measuring adapter for leakage current measurements: for measuring differential leakage current, protective conductor current, neutral current and load current, through leakage current clamp. All wires are separated.	•	•						•
	A 1389	Adapter CEE 5-P 16A / CEE 5-P 16A	Measuring adapter for leakage current measurements: for measuring differential leakage current, protective conductor current, neutral current and load current, through leakage current clamp. All wires are separated.	•	•						•
	A 1390	Adapter CEE 5-P 32A / CEE 5-P 32A	Measuring adapter for leakage current measurements: for measuring differential leakage current, protective conductor current, neutral current and load current, through leakage current clamp. All wires are separated.	•	•						•
	A 1495	Remote control pedal	Remote control pedal is used for safe remote start of high voltage insulation test and additionally allows free hand operation of the worker.						•		•
	A 1495 PL	Adapter for pedal and signal lamps	The adapter is designed to enable use of remote pedal and LED signal lights connected to the instrument.						•		•
	A 1511 2M5	Tip Commander 2,5 m	Tip commander serves as a remote control for execution of passive tests, when used in combination with A 1460. Or for execution of 4-wire continuity test when used directly from MI 3325. The commander has a built in LED torch lamp including PASS/FAIL status LED's and start key for execution of the tests. When used directly from MI 3325 the connection cable A 1583 must be used.						•		•
	A 1511 5M	Tip Commander 5 m							•		•
	A 1511 10M	Tip Commander 10 m							•		•
	A 1694	Tip Commander 2,5 m	Tip Commander A 1694 enables remote controlled execution of tests on large test objects, where test probe is distanced from the test instrument. Consecutive measurements within test loop can be started or stopped with TEST button. Tip Commander A 1694 should only be used with MI 3360 series of METREL test instruments. Full functionality of A 1694 is supported in AUTOSEQUENCE® and Single tests.	•							

• Option













Photo	Part number	Description	Target application	MI 3360	MI 3309 BT	MI 3311	A 1322	A 1422	MI 3394	MI 1601	MI 3325
	A 1583	Connection cable	Connection cable for use of A 1511 tip commander directly from MI 3325.						•		•
	A 1497	Warning lamp / 4 LED's signal tower with buzzer	Colour - LED signal tower with build-in buzzer visually and acoustically signalizes ongoing tests and test conditions for use with A 1460. If A 1497 is used in combination with MI 3325 or MI 3394, an external power supply adaptor A 1499 shall be used.						•		•
	A 1496	Warning lamp / 2-LED signal tower HV	Warning lamps visually signalize ongoing HV insulation test and warn the user about dangerous voltage conditions for use with A 1460. If A 1496 is used in combination with MI 3325 or MI 3394, an external power supply adaptor A 1499 shall be used.						•		•
	A 1496 MAG	Warning lamp / 2-LED signal tower HV ready for magnetic mounting	Warning lamps visually signalize ongoing HV insulation test and warn the user about dangerous voltage conditions.						•		•
	A 1499	External power supply 24V	If the LED tower lamp is used in combination with MI 3325 or MI 3394, the external power supply should be used.						•		•
	A 1079	Discharge time cable	Adaptor for measuring discharge time on internal electronic components.						•		•
	A 1060	Power splitter for discharge time measurement	T-type power splitter for measurements of discharge time on machinery and switchgear.						•		•
	S 1058	Continuity test lead, 2 x 10 m, 2 pcs	Extension test leads for continuity measurements.						•		•
	S 2073	HV test lead 5m, without pistols	High voltage extension test leads for measurements on larger electrical equipment.						•		•
	A 1494 2M	HV test pistol with 2 m cable, blue	High voltage safety test probe for manual high voltage testing. The test tip is protected by an arc-resistant teflon tube, and it has built in almost wear-free lungsten which assures a long lifetime.						•		•
	A 1494 15M	HV test pistol with 15 m cable, blue							•		•
	A 1486 2M	HV test pistol with 2 m cable, red	High voltage safety test probe for manual high voltage testing. The test tip is protected by an arc-resistant teflon tube, and it has built in almost wear-free lungsten which assures a long lifetime.						•		•
	A 1486 15M	HV test pistol with 15 m cable, red							•		•

• Option

Photo	Part number	Description	Target application	MI 3360	MI 3309 BT	MI 3311	A 1322	A 1422	MI 3394	MI 1601	MI 3325	
	S 2078 2M	HV test lead 2m, with pistols, 2pcs	High voltage safety test probe for manual high voltage testing. The test tip is protected by an arc-resistant teflon tube, and it has built in almost wear-free tungsten which assures a long lifetime.						•		•	
	S 2078 15M	HV test lead 15m, with pistols, 2pcs								•		•
	A 1740	Calibration box 5kV	Calibration Box for checking insulation measurements in the field (max. test voltage = 5kV)						•		•	
	A 1593	Large Kelvin test clip	Large robust Kelvin crocodile clip for accurate resistance measurements on larger objects.						•		•	
	A 1595	Large test crocodile, black	Large robust crocodile clip for resistance measurements on larger objects.						•		•	
	A 1596	Large test crocodile, red								•		•
	A 1639 RED-2M5	Large HV Crocodile with cable	HV test clip with cable for best contacting of different contact surfaces with 35 mm jaw opening.						•		•	
	A 1639 RED-5M								•		•	
	A 1639 RED-10M									•		•
	A 1639 RED-15M									•		•
	A 1639 BLU-2M5										•	
	A 1639 BLU-5M								•		•	
	A 1639 BLU-15M								•		•	
	A 1598	Residual Voltage Adapter	3-phase adapter for measurements of discharge time on machinery and switchgear, equipped with 16A CEE 3P socket.								•	
	A 1599	Residual voltage cable	Adapter for measurements of discharge time on machinery and switchgear.								•	
	A 1677	Test lead, 3 x 3 m	3-wire test lead for measuring of single or three phase systems.								•	
	S 1072	Continuity test lead with crocodile clip, 2 x 2.5 m, 2 pcs	Extension test leads with protection shield and with crocodile clips for continuity testing with high test currents (10 A, 25 A).						•		•	
	A 1758	Test lead, black, 1 m	Test lead.	•	•	•			•	•	•	











• Option

Photo	Part number	Description	Target application	MI 3360	MI 3309 BT	MI 3311	A 1322	A 1422	MI 3394	MI 1601	MI 3325
	A 1759	Test lead, brown, 1 m	Test lead.	•	•	•			•	•	•
	A 1760	Test lead, green, 1 m	Test lead.	•	•	•			•	•	•
	A 1761	Test lead, yellow, 1 m	Test lead.							•	
	A 1762	Test lead, violet, 1 m	Test lead.							•	
	S 2012	Continuity test lead, 10 m, 2 pcs (red, black)	2 pieces of extension test lead for continuity measurements.						•	•	
	S 2025	Test lead, 1.5 m, 2 pcs (black, red)	Connection leads for different measurements.						•	•	
	A 1153	Test lead, black, 20 m	Extension test lead for earth and continuity measurements.	•	•	•	•	•	•	•	•
	A 1154	Test lead, black, 4 m	Extension test lead for earth and continuity measurements.		•	•	•	•	•	•	•
	A 1331	Test lead with crocodile clip, black, 1,5 m	Test lead with crocodile clip for PAT testing.	•	•	•					•
	A 1334	IEC cable, 2 m	Additional IEC cable for performing PRCD test.		•						•
	A 1341	Test lead, green 1.5 m	Test lead for PAT safety testing.	•	•						
	A 1342	Test lead, brown 1.5 m	Test lead for PAT safety testing.	•	•						















• Option

Photo	Part number	Description	Target application	MI 3360	MI 3309 BT	MI 3311	A 1322	A 1422	MI 3394	MI 1601	MI 3325	
	A 1309	Crocodile clip, green	Crocodile clip assures secure and permanent contact during the measurement on bus bars, fixing screws, etc.	•	•						•	
	A 1310	Crocodile clip, blue										•
	A 1297	Crocodile clip, brown		•	•						•	•
	A 1013	Crocodile clip, black			•	•					•	•
	A 1064	Crocodile clip, red										•
	A 1546	Crocodile clip, yellow									•	
	A 1062	Test probe, green	Test probe with fi 4 mm connection is suitable for performing measurements both in mains outlets and in situations when no schuko outlet is present.	•	•					•	•	
	A 1015	Test probe, blue										•
	A 1298	Test probe, brown		•	•						•	•
	A 1014	Test probe, black			•	•				•	•	•
	A 1016	Test probe, red								•		•
	A 1268	Test probe, brush type, 4 mm	Test probe, brush type, assures good galvanic contact when measuring on revolving parts, flat surfaces, screw connections and similar. Equipped with standard 4 mm connector.	•	•	•			•		•	
	A 1488	BT Able printer, (battery or mains operated)	Printer supports printing of bar-codes which contain a complete appliance information and PASS or FAIL status of result, or QR codes which contain information of the previous results, the test status, and the previously used test sequence.	•	•	•				•		
	A 1489	Label printer Able, with power and data cables, (battery or mains operated)	Printer supports printing of bar-codes which contain a complete appliance information and PASS or FAIL status of result, or QR codes which contain information of the previous results, the test status, and the previously used test sequence.	•	•	•				•		
	S 2062	BT label printer set, (mains operated)	Printer supports printing of bar-codes which contain a complete appliance information and PASS or FAIL status of result, or QR codes which contain information of the previous results, the test status, and the previously used test sequence.	•	•	•			•	•		
			Printer supports printing of simple labels including PASS or FAIL status of result, Appliance name, ID number, User information and test date.						•	•	•	
	A 1628	Spare label roll for S 2062	Spare label roll for s 2062, 45x90 mm, (800 labels per roll).	•						•	•	
	A 1379	Paper for A 1276, printer	Spare thermal receipt paper for printer A 1276.									
	A 1450	Spare label roll for S 2062	Spare label roll for s 2062, (2500 labels per roll)	•	•	•			•	•	•	
	A 1520	Labels for ABLE printer, (250 labels per roll)	Spare label roll for printer A 1488 and 1489, (250 labels per roll)	•	•					•		
	A 1105	Barcode scanner	Barcode scanner for identification of barcode labelled appliances.	•	•	•			•	•	•	



• Option

Photo	Part number	Description	Target application	MI 3360	MI 3309 BT	MI 3311	A 1322	A 1422	MI 3394	MI 1601	MI 3325
	A 1105 2D	Barcode scanner 2D RS232 connection	2D Barcode scanner for identification of barcode labelled appliances	•					•	•	•
	A 1652	Barcode scanner (Bluetooth)	Barcode scanner for identification of barcode labelled appliances.	•					•		•
	A 1653	QR / Barcode scanner (Bluetooth)	QR / Barcode scanner for identification of barcode labelled appliances.	•					•		•
	A 1106	Barcode labels, 1000 pcs	Appliances can be marked with barcode labels for easier identification.	•	•	•			•	•	•
	A 1571	NFC reader / writer	NFC reader / writer allows to read and upload test results and information about tested electrical equipment to the NFC tags (NTAG 216).	•					•	•	•
	A 1572	NFC tags, fi 34mm self-stick 50 pcs	NFC tags have sufficient memory space to store test results, test code and tested appliance information	•					•	•	•
	A 1573	NFC labels, fi 29 mm self-stick 50 pcs	NFC labels have sufficient memory space to store test results, test code and tested appliance information	•					•	•	•
	A 1574	NFC cable-tie, L 130 mm 50 pcs	NFC cable-ties have sufficient memory space to store test results, test code and tested appliance information	•					•	•	•
	A 1160	Fast charger for 8 AA batteries with a set of 6 NiMH bat., type AA	Fast battery charger for up to 8 pieces of AA rechargeable batteries, and a set of 6 pcs NiMH rechargeable batteries, type AA.		•	•					
	A 1169	Fast charger for AA, C, D and 9 V block batteries	Fast battery charger for up to 12 pcs AA, 6 pcs C or D rechargeable batteries, 4 pcs 9 V block batteries.		•	•					
	A 1017	Communication cable RS232	RS232 interface cable for connecting the instrument with the PC.	•			•	•	•	•	•
	A 1171	RS232 / USB adapter with 1 m cable	RS232 / USB adapter for instruments without USB communication port.		•	•				•	

• Option

Photo	Part number	Description	Target application	MI 3360	MI 3309 BT	MI 3311	A 1322	A 1422	MI 3394	MI 1601	MI 3325
	A 1578	RS232 to USB adapter for external USB keyboard	The A 1578 adapter enables the connection of external USB keyboard, for easy data entering.	•					•	•	•
	A 1436	Bluetooth dongle	External Bluetooth adapter for wireless connection between Metrel's instruments and Smart phones, tablets and PCs.			•					
	A 1305	PC SW PATLink PRO with USB and RS232-PS/2 cable	PC Software PATLink PRO enables downloading, data management and printing of test reports. Comes delivered with RS232-PS/2 and USB communication cables.		•	•					
	A 1306	PC SW PATLink PRO Plus with USB and RS232-PS/2 cable	PATLink PRO Plus is an advanced PC SW which enables downloading, test results analysis, data upload to the instrument and professional test report creation. Delivered with RS232 and USB COM cables.			•					
	A 1203	Upgrade code PATLink PRO to PATLink PRO Plus	Password for upgrading standard PC software PATLink PRO to advanced PC SW PATLink PRO Plus with professional report creation facility.		•	•					
	A 1433	PATLink Android	Enables fast and simple data management of tested appliances, as well as a quick overview of already performed tests by simply scanning a QR code.		•	•					
	A 1434	aPATLink Android				•					
	P 1100	Metrel FW Profile Licence Key With BASIC SW Set	Licence key for an additional FW profile and BASIC MESM functionality.	•					•		•
	P 1101	Metrel MESM BASIC to PRO licence key Upgrade	Licence key for upgrading the Metrel ES Manager to advanced version with professional report creation and Excel PRO export functionality.	•	•				•		•
	P 1102	Metrel FW Profile Licence Key With PRO SW Set	Licence key for an additional FW profile and PRO MESM functionality.	•					•		•
	P 1104	Metrel SDK Licence Key	SDK Licence key for instrument integration with 3rd party SW.	•	•				•	•	•
	P 1301	MI 3360 M licence key	Licence key for unlocking medical device testing functionality (in accordance with EN 62353) on MI 3360 25A OmegaGT XA.	•							
	P 1102-AND	Metrel aMESM PRO Licence Key Upgrade (A 1522)	The aMESM is an advanced portable appliance safety Testing tool for Android devices. The Application is free for download from the Android Market via Google Play. For a full-featured application, a special Licence is needed. Please contact your local distributor for further information.	•					•		•
	A 1521	USB isolator	It is intended as galvanic insulation of USB interface between our products and PC to prevent damage of USB connected equipment in case of accidentally applied voltage difference between two types of equipment.						•		•

• Option

Photo	Part number	Description	Target application	MI 3360	MI 3309 BT	MI 3311	A 1322	A 1422	MI 3394	MI 1601	MI 3325
	A 1458	SanDisk MicroSD card reader	Move data between your computer and memory card with memory card reader.	•					•		•
	A 1737	Carrying case	Case with foam inserts with slots for a Eurotest multifunctional electrical installation safety tester and MI 3309 BT DeltaGT. Multiple possible instrument & accessory combinations. We recommend the MI 3110 EurotestIT, MI 3309 DeltaPAT, MD 9231 AC/DC current clamp and A 1207 three phase adapter combination.		•						
	S 2138	S 2138 Set of wheels for carrying cases A 1736, A 1737, A 1738	Wheels and trolley that can be added to carrying cases for easier transport.		•						
	A 1271	Carrying bag (S)	Small soft carrying bag for transport and storage of test instrument or accessories.		•	•	•	•	•		
	A 1289	Carrying bag (M)	Large soft carrying bag for transport and storage of test instrument and belonging accessories.	•	•	•	•	•	•		
	A 1550	Carrying bag (XXL)	Large soft carrying bag for transport and storage of test instrument and belonging accessories.	•							
	A 1302	Set of carrying straps	Set of carrying straps for carrying the measuring instrument around the neck allowing free hand use of the tester.		•	•					
	A 1303	Soft hand strap	Soft hand strap for holding the instrument.		•	•					

• Option





# Content

## Power Quality Analysis

Electrical Installation Safety	1.1 - 1.72
High Voltage Insulation / Continuity / Earth / Transformer	2.1 - 2.48
Appliance / Machine / Switchboard Safety	3.1 - 3.52
<b>POWER QUALITY ANALYSIS</b>	<b>4.1 - 4.26</b>
Equipment for laboratories and Schools	5.1 - 5.16
Multimeters / Clamp meters / Voltage testers / Thermal cameras	6.1 - 6.44
Software	7.1 - 7.19
<b>GOOD TO KNOW</b>	
Power Quality Analysis	4.02
<b>POWER QUALITY ANALYSERS</b>	
Selection Guide for Power Quality Analysers	4.04
Differences for Power Quality Analysers	4.05
Comparison for Power Quality Analysers	4.05
Selection Guide for Clamps	4.06
MI 2893 Power Master XT	4.08
MI 2892 Power Master	4.10
MI 2885 Master Q4	4.12
MI 2884 Energy Master XA	4.14
MI 2883 Energy Master	4.16
<b>OTHER INSTRUMENTS / ADAPTERS / ACCESSORIES</b>	
A 1685 / A 1565 / A 1577 Professional protective waterproof case	4.18
CS 2890 Power Calibrator / Simulator	4.20
<b>SELECTION GUIDE FOR PQA ACCESSORIES</b>	<b>4.22</b>

# Good to know

## Power Quality Testing

### Find out more about modern power quality measurement techniques

There are quite a few reasons for measuring and analysing power quality nowadays. Potential interactions between end use equipment and electric distribution system, external electromagnetic interferences, resonant states between electrical circuits and some other factors call for a need to be analysed in order that harmful consequences can be omitted or prevented. Power quality analysing includes measurements of:

- Phase to ground voltages;
- Phase to neutral voltages;
- Neutral to ground voltages;
- Phase to phase voltages in three-phase systems;
- Phase currents;
- Current in a neutral conductor;
- Frequency;
- Power Factor,  $\cos \phi$ ;
- Harmonic components of current and voltage and their direction;
- Waveform of current and voltage at specific circumstances (peak magnitude, primary frequency, time of occurrence, rising rate);
- Transients.

### Active Power (P)

Active power is the power which is actually consumed or generated in an AC circuit over a resistive load. It is measured in watts (W) or kilowatts (kW).

### Reactive Power (Q)

Reactive power is the power that is provided by generators, synchronous condensers, or electrostatic equipment such as capacitors and directly influences electric system voltage. The portion of electricity that establishes and sustains the electric and magnetic fields of alternating-current equipment. This is measured in Volt-Ampere (var).

### Apparent Power (S)

Apparent power is the perceived power from a load that has both active and reactive components. Apparent power is the vector sum of both active and reactive power and is usually measured in Volt-Amperes (VA).

### Power Factor

Power factor is a measure of a power system's efficiency and is the ratio of real power to apparent power.

### Energy

Energy is the generation or use of electric

power over a period of time. This is usually expressed in kilowatt-hours (kWh).

### Fundamental frequency

The fundamental frequency is the lowest and most predominant frequency in a power system (e.g. the fundamental frequency of the mains voltage in the EU is 50 Hz). The fundamental frequency is also called the 1<sup>st</sup> harmonic of the system.

### Voltage events

#### Dips

Supply voltage dip represents temporary drops of the voltage under the nominal level.

#### Swells

Supply voltage swells represents temporary voltage increases over the nominal level.

#### Interruptions

Interruption is classified as large decrease in the voltage supply level or a complete loss of voltage.

### Unbalance

Supply voltage unbalance arises when rms values or phase angles between consecutive phases are not equal.

### Harmonics

Harmonics are integer frequency multiplication of the fundamental frequency (e.g. with a fundamental of 50 Hz, the 2<sup>nd</sup> harmonic is  $50 \times 2 = 100$  Hz, 3<sup>rd</sup> harmonic is  $50 \times 3 = 150$  Hz). Harmonics can be caused by a variety of modern day equipment including resonating transformers, switch-mode power supplies, IT equipment, etc.

### Interharmonics

Interharmonics are harmonics that are not an integer multiplication of the fundamental frequency. The main sources of interharmonic waveform distortion are static frequency converters, induction motors and arcing devices.

### Total Harmonic Distortion (THD)

THD is the ratio of a wave's harmonic content (for voltage or current) to its fundamental component.

### Total Demand Distortion (TDD)

Total Demand Distortion is calculated harmonic current distortion against the full load of the electrical system. TDD gives better insight about impact of harmonic distortion in the system.

### Transients

Transient is a term for short, highly damped momentary voltage or current disturbance. They usually appear as a consequence of external electromagnetic interferences (atmospheric electric discharges, switching manoeuvres).

### Flickers

Flicker appears as changing illumination intensity which is a reflection of a changing voltage level.

### Inrush current

As a motor begins the current needed to start the motor can be 10 to 15 times the normal operating current. This initial surge of current can cause dips in voltage and can be hard to analyse with normal test instruments, for this reason an analyser with a fast logging function is required.

### Instrument connection to the LV and MV Power Systems

When connecting the instrument it is essential that both current and voltage connections are correct. In particular the following rules have to be observed:

Current clamp-on current transformers

- The arrow marked on the clamp-on current transformer has to point in the direction of current flow, from supply to load;
- If the clamp-on current transformer is connected in reverse the measured power in that phase would normally appear negative.

Phase relationships

- The clamp-on current transformer connected to current input connector I1 has to measure the current in the phase line to which the voltage probe from L1 is connected.

In case of events capturing, it is recommended to connect unused voltage inputs to N voltage input.

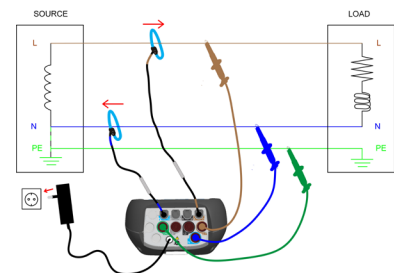

Connection to 1-phase 3-wire system

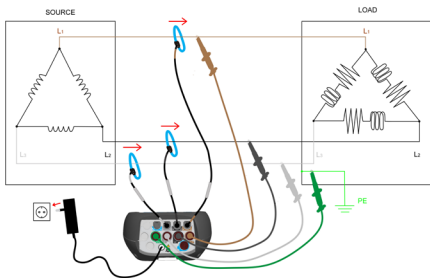

Connection to 3-phase 3-wire system

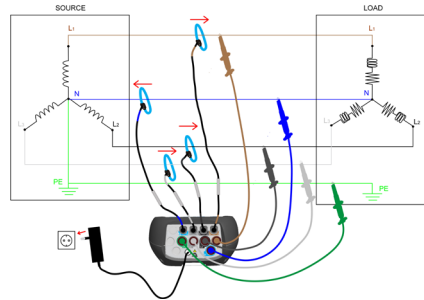

Connection to 3-phase 4-wire system

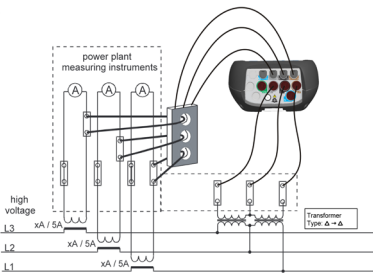

Connecting instrument to the existing current transformers in medium voltage system

### Recommended Recording Practice

Power quality measurements are specific type of measurements, which can last several days or even up to several weeks. Usually recording campaign is performed to:

- Statistically analyse some point in the network.
- Troubleshoot malfunctioning device or machine.

Mostly long-term measurements are performed only once, so why it is very important to properly set measuring equipment. Measuring with wrong setting can lead to false or useless measurement results. In the following flow chart recommended recorder procedure is shown (with MI 2892 PowerMaster).

### Power quality improvement

Captured with Power Analyser data can be

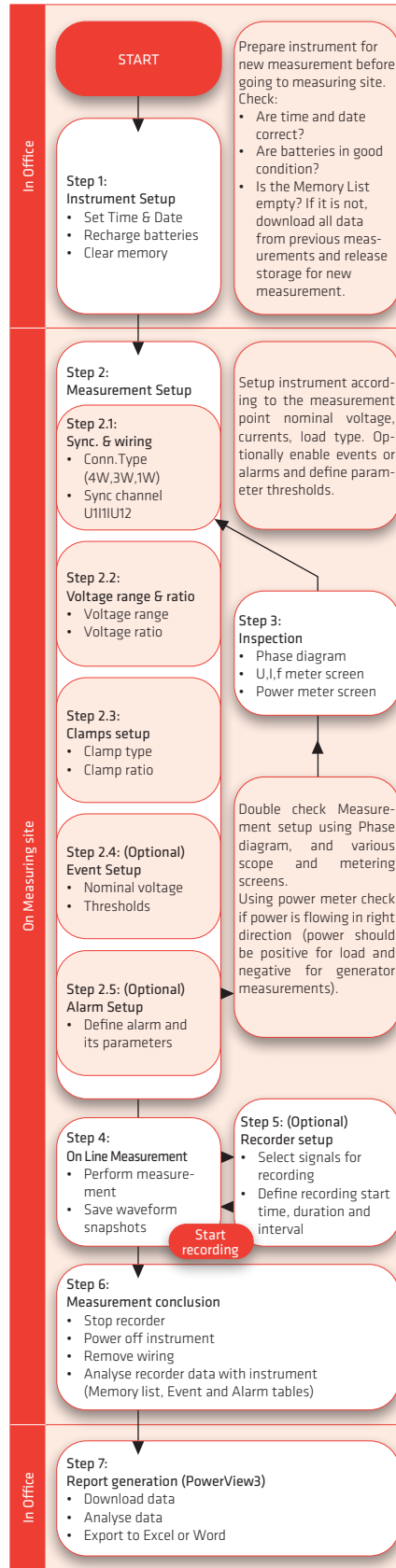

used for improvement of supplied power quality. There are different ways to increase efficiency of power supply.

### Cutting power peaks

One of the simplest and the most efficient way to decrease the electricity power bill is by lowering peaks of consumed power (peak demand). This can be achieved by:

- reorganization of production processes;
- embedded generation.

The first solution can be implemented in systems where some tasks can be stopped or rescheduled.

The second solution can be implemented in systems with generators that are often used as a back-up power supply. Both solutions require additional monitoring and control systems that are designed upon previously conducted measurement and analysis of the situation in the field. Another possibility to increase efficiency is by increasing the power factor using corrective techniques.

### Capacitor Banks

Capacitor banks are the devices most susceptible to the presence of harmonics. Since consumer's loads usually have inductive characteristics, capacitor banks are used for compensation of inductive currents. This feature allows:





- better overall system performance;
- increasing availability of active power;
- decreasing transmission losses;
- increasing voltage;
- decreasing financial penalty because of poor power factor.

### EN 50160 Standard Overview

EN 50160 is one of the most important standards in field of power quality which defines, describes and specifies the main characteristics of the voltage at a network user's supply terminals in public low voltage and medium voltage distribution networks under normal operating conditions. This standard describes the limits or values within which the voltage characteristics can be expected to remain over the whole of the public distribution network and does not describe the average situation usually experienced by an individual network user.





# Power Quality Analysers

## Selection Guide for Power Quality Analysers

MEASUREMENTS	MI 2893 Power Master XT	MI 2892 Power Master	MI 2885 Master Q4	MI 2884 Energy Master XA	MI 2883 Energy Master
					
<b>STANDARD</b>					
IEC 61000-4-30 Compliance; Ed. 3.0	Class A (Independent certificate)	Class A (Independent certificate)	Class S (Independent certificate - 0,1%)	Class S (0,2%)	Class S (0,2%)
<b>INPUTS</b>					
Number of current measuring channels	4	4	4	4	4
Number of voltage measuring channels	4	4	4	3	3
Automatic range selection/auto-ranging	• / •	• / •	• / •	• / •	• / •
1-phase flexible current clamps 3000/300/30 A (included in Advance set (AD) and Euro set (EU) set)	4	4	4	3	3
<b>MEASUREMENTS</b>					
TRMS Current measurement (Min., Max., AvgON)	•	•	•	•	•
TRMS Voltage measurement (Min., Max., AvgON)	•	•	•	•	•
Scope function	•	•	•	•	•
On-line harmonics measurement	•	•	•	•	•
Frequency measurement	•	•	•	•	•
Power measurement (W, VA, VAR)	•	•	•	•	•
THD and harmonics analysis	•	•	•	•	•
Interharmonics analysis	•	•	•	•	•
Power Factor cos fi and tg fi	•	•	•	•	•
Registration of voltage events (sags, swells, interruptions)	•	•	•	•	•
Statistical evaluation	•	•	•	•	•
Current in neutral conductor	•	•	•	With optional clamp	With optional clamp
Phase diagram	•	•	•	•	•
Unbalance	•	•	•	•	•
EN 50160 Analysis / IEEE 519 / Energy consumption optimization	• / • / •	• / • / •	• / • / •	• / • / •	• / • / •
Flicker measurement	•	•	•	•	•
Transients measurement	• (1 MSamples/sec)	• (49 kSamples/sec)	• (49 kSamples/sec)	• (30 kSamples/sec)	•
Waveform recording	•	•	•	•	•
Inrush currents	•	•	•	•	•
VFD (variable frequency drives)	•	•	•	•	•
Photo voltaic efficiency measurement	•	•	•	•	•
Energy measurement	•	•	•	•	•
Signalling	•	•	•	•	•
Temperature measurement	•	•	Optional	Optional	Optional
Integration period	1 ... 7200 s	1 ... 7200 s	1 ... 7200 s	1 ... 7200 s	1 ... 7200 s
Power measurements in compliance with IEEE 1459	• / •	• / •	• / •	• / •	• / •
Classic (vector or arithmetic)	•	•	•	•	•
Simultaneous General / waveform	•	•	•	•	•
Connection check	•	•	•	•	•
Colour coding	•	•	•	•	•
<b>COMMUNICATION PORTS</b>					
USB	•	•	•	•	•
RS232	For GPS only	For GPS only	For GPS only	•	•
GPS time synchronisation	Optional	Optional	Optional	•	•
Remote instruments control (4G / WiFi)	Optional	Optional	Optional	•	•
Remote instruments control (Ethernet / Intranet)	• / •	• / •	• / •	•	•
<b>GENERAL</b>					
Graphical LCD with backlight (480x272 4.3" color TFT)	•	•	•	•	•
On-site analysis of recorded data	•	•	•	•	•
Built-in power supply for flexible clamps	•	•	•	•	•
Maximal recording time	Over a year	Over a year	Over a year	Over a year	Over a year
Memory module size 8 GB supplied (up to 32 GB)	•	•	•	•	•
PC Software PowerView3	•	•	•	•	•
Maximal test voltage – interphase value	1730 V rms	1730 V rms	1730 V rms	1730 V rms	1730 V rms
Maximal test voltage – between phase and N conductors	1000 V rms	1000 V rms	1000 V rms	1000 V rms	1000 V rms
Maximum transient peak voltage	6 kV	6 kV	6 kV	6 kV	6 kV
Frequency range	50 Hz /60 Hz 42.500Hz ... 69.000Hz	50 Hz /60 Hz 42.500Hz ... 69.000Hz	50 Hz /60 Hz 42.500Hz ... 69.000Hz	50 Hz /60 Hz 42.500Hz ... 69.000Hz	50 Hz /60 Hz 42.500Hz ... 69.000Hz
VFD (5 Hz - 120 Hz)	VFD (5 Hz - 120 Hz)	VFD (5 Hz - 120 Hz)	VFD (5 Hz - 120 Hz)	VFD (5 Hz - 120 Hz)	VFD (5 Hz - 120 Hz)
400 Hz	400 Hz	400 Hz	400 Hz	•	•
Over voltage category	CAT IV / 600 V CAT III / 1000 V	CAT IV / 600 V CAT III / 1000 V	CAT IV / 600 V CAT III / 1000 V	CAT IV / 600 V CAT III / 1000 V	CAT IV / 600 V CAT III / 1000 V
AC power supply	•	•	•	•	•
Built-in battery charger	•	•	•	•	•
Rechargeable batteries (NiMH)	6 x AA	6 x AA	6 x AA	6 x AA	6 x AA
Weight	1.10 kg	0.96 kg	0.96 kg	0.96 kg	0.96 kg
Dimensions (mm)	230 x 140 x 80	230 x 140 x 80	230 x 140 x 80	230 x 140 x 80	230 x 140 x 80





# Power Quality Analysers

## Differences between Power Quality Analysers

Class A		Class S		
MI 2893 Power Master XT	MI 2892 Power Master	MI 2885 Master Q4	MI 2884 Energy Master XA	MI 2883 Energy Master
				
<p>Flagship of our line of Class A power quality analysers with high sampling rate for transient capturing intended for professional users specialized for investigating transients in the network and high accuracy measurements.</p> <ul style="list-style-type: none"> <li>Class A 0,1% (independent certificate)</li> <li>Top tier PQA instrument</li> <li>General recorder</li> <li>Waveform recorder</li> <li>Transient recorder working simultaneously with waveform and general recorder (1 MSamples/sec)</li> </ul>	<p>Advanced selection of power quality analysers and aimed primarily at dedicated professionals, who specialize in high accuracy measurements and analysis, whose validity is backed by a Class A independent certificate.</p> <ul style="list-style-type: none"> <li>Class A 0,1% (independent certificate)</li> <li>Advanced PQA instrument</li> <li>General recorder</li> <li>Waveform recorder</li> <li>Transient recorder (49 kSamples/sec)</li> </ul>	<p>Designed for power quality assessment and troubleshooting in low and middle voltage electrical systems and checking power correction equipment performance and verification of electrical system capacity before adding new loads.</p> <ul style="list-style-type: none"> <li>Class S 0,1% (independent certificate)</li> <li>Intermediate PQA instrument</li> <li>General recorder</li> <li>Waveform recorder</li> <li>Transient recorder (49 kSamples/sec)</li> </ul>	<p>For advanced users interested in long term monitoring and analysis of electrical systems for the purpose of energy quality and consumption management and formulation of cost saving measures with additional simultaneous waveform, inrush recording and transient detection.</p> <ul style="list-style-type: none"> <li>Class S (0,2%)</li> <li>Enhanced PQA instrument</li> <li>General recorder</li> <li>Waveform recorder</li> <li>Transient recorder (30 kSamples/sec)</li> </ul>	<p>For users interested in long term monitoring and analysis of electrical systems for the purpose of energy quality and consumption management and formulation of cost saving measures.</p> <ul style="list-style-type: none"> <li>Class S (0,2%)</li> <li>Basic PQA instrument</li> <li>General recorder</li> </ul>





# Power Quality Analysers

## Comparison between Power Quality Analysers

MODEL		MI 2893 Power Master XT	MI 2892 Power Master	MI 2885 Master Q4	MI 2884 Energy Master XA	MI 2883 Energy Master
						
<b>STANDARD</b>	IEC 61000-4-30 Compliance	Class A (independent certificate)	Class A (independent certificate)	Class S (Ind. certificate - 0,1%)	Class S (0,2%)	Class S (0,2%)
	EN 50160	•	•	•	•	•
<b>GENERAL RECORDER MEASUREMENTS</b>	Limited / Standard profile	• / •	• / •	• / •	• / •	• / •
	Voltage AC + DC	•	•	•	•	•
	Current AC +DC	•	•	•	•	•
	Frequency	•	•	•	•	•
	Power measurements in compliance with IEEE 1459 / Classic (vector or arithmetic)	• / •	• / •	• / •	• / •	• / •
	Energy	•	•	•	•	•
	Harmonics	•	•	•	•	•
	Interharmonics	•	•	•	•	•
	Flickers and RVC	•	•	•	•	•
	Phase diagram	•	•	•	•	•
	Signalling	•	•	•	•	•
	Under/Over voltage deviation	•	•	•	•	•
	Interrupts, Dips, Swells	•	•	•	•	•
	Alarms	•	•	•	•	•
	Phase diagram	•	•	•	•	•
	Neutral current	•	•	•	Optional	Optional
	Temperature	•	•	Optional	Optional	Optional
<b>WAVEFORM RECORDER (TRIGGERS ON)</b>	Events	•	•	•	•	•
	Alarms	•	•	•	•	•
	Level I (Inrush recorder)	•	•	•	•	•
	Level U (Inrush recorder)	•	•	•	•	•
	Time interval	•	•	•	•	•
<b>TRANSIENT RECORDER (TRIGGERS ON)</b>	Envelope	•	•	•	•	•
	Level (I, In, U, Un)	•	•	•	•	•
	Transient selection between N / GND	• / •	• / •	• / •	• / •	• / •
<b>TROUBLESHOOTING FEATURES</b>	On-line scope mode	•	•	•	•	•
	Waveform snapshot	•	•	•	•	•
	GPS receiver	Optional	Optional	Optional	•	•
	WiFi / 4G modem	Optional	Optional	Optional	•	•
<b>REMOTE COM</b>	Ethernet / Intranet	• / •	• / •	• / •	•	•
<b>MICROSD CARD</b>	8 GB	•	•	•	•	•
<b>PC SW</b>	PowerView3	•	•	•	•	•

# Power Quality Analysers

## Selection Guide for Clamps

Part No.	Smart Clamps	Description	Target application	MI 2893	MI 2892	MI 2885	MI 2884	MI 2883
A 1501		• 1-phase mini flexible current clamp 3000/300/30 A / 1V	Single phase flexible current clamp with three selectable measuring ranges. Does not require external power supply as it is powered by the measuring instrument.	•	•	•	•	•
A 1502		• 1-phase mini flexible current clamp 3000/300/30 A / 1V	Single phase flexible current clamp with three selectable measuring ranges. Does not require external power supply as it is powered by the measuring instrument.	•	•	•	•	•
A 1609		• 1-phase mini flexible current clamp 3000/300/30 A / 1V	Single phase flexible current clamp with three selectable measuring ranges. Does not require external power supply as it is powered by the measuring instrument.	•	•	•	•	•
A 1503		• 1-phase mini flexible current clamp 6000/600/60 A / 1V	Single phase flexible current clamp with three selectable measuring ranges. Does not require external power supply as it is powered by the measuring instrument.	•	•	•	•	•
A 1227		• 1-phase flexible current clamp 3000/300/30 A / 1V	Single phase flexible current clamp with three selectable measuring ranges. Does not require external power supply as it is powered by the measuring instrument.	•	•	•	•	•
A 1445		• 1-phase flexible current clamp 3000/300/30 A / 1V	Single phase flexible current clamp with three selectable measuring ranges. Does not require external power supply as it is powered by the measuring instrument.	•	•	•	•	•
A 1446		• 1-phase flexible current clamp 6000/600/60 A / 1V	Single phase flexible current clamp with three selectable measuring ranges. Does not require external power supply as it is powered by the measuring instrument.	•	•	•	•	•
A 1582		• 1-phase flexible current clamp 3000/300/30 A / 1V; high temperature	Single phase, high temperature (sensor: -20 to 200 °C, module: -20 to 70 °C) flexible current clamp with three selectable measuring ranges. Does not require external power supply as it is powered by the measuring instrument.	•	•	•	•	•
A 1281		• Current clamp 0.5/5/100/1000 A / 1V	High accuracy current clamp for precise current and power measurements including leakage current measurement.	•	•	•	•	•
A 1588		• Current clamp 0.5/5/50A / 1V	High accuracy current clamp for precise current and power measurements including leakage current measurement. Does not require external power supply as it is powered by the measuring instrument.	•	•	•	•	•
A 1069		• Mini current clamp 100 A / 1V	Mini current clamp for power measurements. Requires A 1561 connection cable.	•	•	•	•	•
A 1398 PQA		• Current clamp 10A / 1V	High accuracy current clamp for precise current and power measurements including leakage current measurements.	•	•	•	•	•
A 1391 PQA		• Current clamp AC/DC 40/300 A / 1V	AC + DC current clamp for power measurements. Battery 9V.	•	•	•	•	•
A 1636		• Current clamp AC/DC 1500 A	AC+DC current clamp intended for power measurements, specially for photo-voltaic inverters (DC side). Battery operated (9 V)	•	•	•	•	•
A 1717		• Current clamp AC/DC 100/1000A / 1V	AC+DC current clamp intended for power measurements, specially for photo-voltaic inverters and DC/AC converters /DC side). Battery operated (9V). Requires A 1561 connection cable.	•	•	•	•	•
A 1037		• Current transformer 5 A / 1V	3-phase transformer for power measurements on distribution panels.	•	•	•	•	•

### SMART CLAMPS KEY FEATURES:

- Cover wide current range;
- Are automatically recognized by the instrument;
- Are switchless (range selection on the instrument);
- Do not require external power supply.

# Power Quality Analysers

## Selection Guide for Clamps

Part No.	Type	Jaw opening/loop	Ranges	Measurement Ranges	RMS accuracy 50/60 Hz	Phase accuracy 50/60 Hz	RMS accuracy 1500 Hz	Phase accuracy 1500 Hz	Overvoltage category; IP
A 1501	s-Flex	fi 7 cm Sensor length: 25 cm	30 A 300 A 3000 A	3 A ... 60 A 5 A ... 600 A 50 A ... 6000 A	± 1 % ± 1 % ± 1 %	< 1°	± 3 %	< 10°	CAT IV / 600 V; IP 64
A 1502	s-Flex	fi 14 cm Sensor length: 48 cm	30 A 300 A 3000 A	3 A ... 60 A 5 A ... 600 A 50 A ... 6000 A	± 1 % ± 1 % ± 1 %	< 1°	± 3 %	< 10°	CAT IV / 600 V; IP 64
A 1609	s-Flex	fi 54 cm Sensor length: 175 cm	30 A 300 A 3000 A	3 A ... 60 A 5 A ... 600 A 50 A ... 6000 A	± 1 % ± 1 % ± 1 %	< 1°	± 3 %	< 10°	CAT IV / 600 V; IP 64
A 1503	s-Flex	fi 27 cm Sensor length: 90 cm	60 A 600 A 6000 A	6 A ... 120 A 10 A ... 1200 A 100 A ... 12000 A	± 1 % ± 1 % ± 1 %	< 1°	± 3 %	< 10°	CAT IV / 600 V; IP 64
A 1227	Flex	fi 14 cm Sensor length: 48 cm	30 A 300A 3000 A	3 A ... 60 A 10 A ... 600 A 60 A ... 6000 A	± 1 % ± 1 % ± 1 %	< 1°	± 3 %	< 10°	CAT IV / 600 V; IP 64
A 1445	Flex	fi 19 cm Sensor length: 61 cm	30 A 300A 3000 A	3 A ... 60 A 10 A ... 600 A 60 A ... 6000 A	± 1 % ± 1 % ± 1 %	< 1°	± 3 %	< 10°	CAT IV / 600 V; IP 64
A 1446	Flex	fi 27 cm Sensor length: 90 cm	60 A 600A 6000 A	6 A ... 120 A 20 A ... 1200 A 120 A ... 12000 A	± 1 % ± 1 % ± 1 %	< 1°	± 3 %	< 10°	CAT IV / 600 V; IP 64
A 1582	Flex	fi 19 cm Sensor length: 61 cm	30 A 300A 3000 A	3 A ... 60 A 10 A ... 600 A 60 A ... 6000 A	± 1 % ± 1 % ± 1 %	< 1°	± 3 %	< 10°	CAT IV / 600 V; IP 64
A 1281	Iron	Jaw opening: 5.2 cm Max. conductor size < 50 mm	0.5 A 5 A 100 A 1000 A	50 mA ... 1 A 0.5 A ... 10 A 10 A ... 175 A 100 A ... 1200 A	± 0,5 % ± 0,5 % ± 0,5 % ± 1,2 %	< 0.5°	± 1.5 %	< 1.5°	CAT III / 600 V; IP 20
A 1588	Iron	Jaw opening: 40 mm Max. conductor size < 50 mm	0.5A 5A 50A	50 mA ... 1 A 0.5 A ... 10 A 5 A ... 100 A	± 0.5 % ± 0.5 % ± 0.5 %	< 0.5 °	± 1.5 %	< 3 °	CAT II / 600 V; IP 40
A 1069	Iron	Jaw opening: 13 mm Jaw cross-section: 15 x 17 mm	100 A 10 A	5 A ... 200 A 500 mA ... 20 A	± 1 % ± 1 %	< 3°	± 3 %	< 2°	CAT III / 600 V; IP 20
A 1398 PQA		Jaw opening: 13 mm Max. conductor size < 13 mm	10 A	0.5A ... 20 A	± 0.5%	< 0.45°	± 1.5 %	< 3°	CAT II / 300 V; IP 40
A 1391 PQA	Iron	Jaw opening: 2.5 cm Max. conductor size < 22mm	AC/DC 40 A 300 A	2 A ... 40 A 20 A ... 300 A	± 3 % ± 3 %	< 3°	± 3 %	< 10°	CAT IV / 600 V; IP 64
A 1636	Iron	Jaw opening: 7,3 cm Max. conductor size < 68 mm	AC/DC 1500 A	45 ... 1500 A	± 3 % FS	< 3 °	± 3 % FS	< 6 °	CAT III / 600 V; IP 40
A 1717	Iron	Jaw opening: 5.1 cm Max. conductor size < 52 mm	AC/DC 100 A 1000 A	3 A ... 100 A 30 A ... 1000 A	± 1 % m.v. ± 1 A	< 0.5°	± 2 %	< 1.5°	CAT III / 600 V; IP 40
A 1037	Iron	N/A	0.5 A 5 A	10 mA ... 1 A 0.5 A ... 10 A	± 0,3 % ± 0,3 %	< 0.5°	± 1 %	< 1.0°	CAT III / 600 V; IP 40

Ranges are specified for pure sine wave, reduced crest factor (< 1.5),

# Power Quality Analysers

## MI 2893 Power Master XT



The MI 2893 Power Master XT is a hand-held three phase power quality analyzer with a large easy-to-read graphical color display enabling the user to detect harmonics, phasors, waveforms and transients with sampling frequency 1 MSamples/sec in the installation simply by connecting the device. The instrument is designed for a long term recording as well as for troubleshooting power quality problems in three-phase and single-phase power distribution systems. The handy Quick Set buttons makes the instrument more user friendly and are allowing faster data overview for troubleshooting. Advanced PC SW package PowerView3 enables detailed analysis of recorded data, direct and remote reading from the micro SD memory card, analysis of long term records and automatic creation of professional test report.

### MEASURING FUNCTIONS

- Voltage: TRMS, peak, crest factor (4-channel);
- Current: TRMS, peak, crest factor (4-channel);
- Power (active, reactive, apparent);
- **Power measurements fully compliant with IEEE 1459 (active, non active, fundamental, harmonic, load unbalance) and classic (vector or arithmetic) method;**
- **VFD (variable frequency drive, 5 Hz – 120 Hz), 400 Hz;**
- Unbalance, flicker measurement;
- Harmonic and interharmonic analysis up to **50th harmonics, THD and TDD measurements;**
- **Energy (active, apparent, reactive, apparent, generated, consumed);**
- Capturing and recording of power supply events (shutdowns, interruptions, swells, dips);
- Inrush currents monitoring and recording;
- Waveform/inrush displaying, snapshot and recording;
- **Transients with sampling frequency 1 MSamples/sec;**
- Power quality analysis according to EN 50160, IEEE 519;
- Recording up to 7 adjustable alarms;
- Temperature measurement;
- Power factor,  $\cos \phi$  and  $\text{tg } \phi$ .

### KEY FEATURES

- 4-voltage channels with wide measurement range;
- 4-current channels with support for automatic clamp recognition and “on instrument” range selection;
- Automatic Smart Clamp detection and Smart Clamp range selection;
- Current clamp auto range selection;
- **Sampling frequency on transients recording > 1 MSamples/sec, on 8 channels simultaneously;**
- **Compliance with power quality standard IEC 61000-4-30 Class A;**
- Complete power quality analysis according to EN 50160 including signalling and interharmonics;
- Support for microSD memory card (8-GB supplied with the instrument) up to 32GB;
- Color-coded input terminals and terminal labels to suit your application region;
- Intuitive main menu and large icons that makes the equipment very easy to navigate and configure;
- Powerful PC SW PowerView3 enables downloading, view, analysis of recorded data and professional report creation;
- Flexible clamps (without additional power supply) are included in the AD/EU set;
- Remote communication via Ethernet;
- GPS clock synchronization (optional).

### APPLICATION

- **High speed transient capturing;**
- Energy consumption optimization;
- Power quality assessment and troubleshooting in low and middle voltage electrical systems;
- Checking power correction equipment performance;
- Long-term analysis;
- Predictive maintenance;
- Verification of electrical system capacity before adding loads.

### STANDARDS

#### Safety:

- EN 61010-1

#### Measurements:

- IEC/EN 61000-4-30, Class A;
- IEC/EN 61557-12;
- IEC/EN 61000-4-7, Class I;
- IEC/EN 61000-4-15;
- EN 50160;
- IEEE 1459;
- IEEE 519

#### Electromagnetic compatibility (EMC):

- EN 61326



## TECHNICAL DATA

FUNCTION		
<b>Voltage inputs</b>	<b>AC+DC</b>	
Number of inputs	5	
<b>Nominal voltage range</b>		
Three phase connection	Phase (L-N): 50 ... 1000 V RMS Line (L-L): 87 ... 1730 V Phase (L-N): 50 ... 500 V RMS	
Single phase connection		
<b>Measuring range</b>		
Three phase connection	10 % ... 150 % of nominal voltage	
Single phase connection	10 % ... 110 % of nominal voltage	
Max. transient peak voltage	±6 kV	
Accuracy	IEC 61000-4-30 Class A, ±0.1% of nominal voltage, 7 kSamples per second @ 50/60 Hz, synchronization with main frequency	
Sampling rate	1.7 kSamples per second @ VFD (5 Hz - 120 Hz) 12.2 kSamples per second @ 400 Hz	
Mains frequency range	42.5 ... 69.0 Hz ±10 mHz 5 ... 120 Hz ± 10 mHz (VFD) 335.0 ... 465.0 Hz ± 100 mHz	
<b>Current inputs</b>	<b>AC+DC</b>	
Number of inputs	4	
Measuring range:		
Range 1	10.0 mVRMS ... 300.0 mVRMS ±0.25 % URMS	
Range 2	50.0 mVRMS ... 3.000 VRMS ±0.25 % URMS	
<b>Functions</b>	<b>Measuring range</b>	<b>Accuracy</b>
Power (P, Q, S, cos φ, PF...)	Depends on voltage and selected clamps	IEC 61557-12 Class 1
Energy	Depends on voltage and selected clamps	Active: IEC 62053-21 Class 1 Reactive: IEC 62053-23 Class 2
Harmonics (DC ... 50th) @50/60 Hz	0 ... 20% of nom. voltage	IEC 61000-4-7 Class 1
Harmonics (DC ... 13th) @400 Hz		
Harmonics (DC ... 20th) @VFD (5 - 16 Hz)		
Harmonics (DC ... 13th) @VFD (16 - 33 Hz)		
Harmonics (DC ... 5th) @VFD (33 - 120 Hz)		
Interharmonics (1 ... 50th) @ 50/60 Hz	0 ... 20% of nom. voltage	IEC 61000-4-7 Class 1
Interharmonics (1 ... 20th) @VFD (5 - 16 Hz)		
Interharmonics (1 ... 13th) @VFD (16 - 33 Hz)		
Interharmonics (1 ... 5th) @VFD (33 - 120 Hz)		
Flicker	0.2 ... 10	IEC 61000-4-15 Class F3
Mains signalling	0 ... 15% of nom. voltage	IEC 61000-4-30 Class A
Unbalance	Voltage: 0 ... 5% Current: 0 ... 20%	
Temperature	-10 ... 85 °C	±0.5 °C
Dips, Swell	10 ... 150% of nom. voltage	±0.2 % of nominal voltage ±1 cycle
Interrupts	0 ... 10% of nom. voltage	±1 cycle
<b>Recorders</b>		
Memory	8GB microSD, up to 32GB supported	
<b>General recorder</b>		
Integration period	1s ... 2h	
Recorded signals	> 1000 (voltages, currents, harmonics, power...) Minimal, maximal, average and average ON value per interval, including - Voltage events (dip, swell, interrupt) - Custom alarms (up to 7 programmable alarms) - Signalling (up to two selectable frequencies) - Transients - Inrush	
Duration	> 1 year (depends on size of SD card at 10 min registration period)	
<b>Waveform recorder</b>		
Duration	Up to 60 seconds duration and 30 seconds pretrigger of voltage and current waveform	
Trigger	Up to 1500 records Manual, Voltage Events, Custom Alarms, Voltage or current level (inrush), Time interval	
<b>Transient recorder</b>		
Sampling rate	1 MSamples/sec; simultaneously on all 8 channels	
Duration	One cycle of voltage and current waveforms	
Trigger	Transient selection measurement between L-N/L-GND Envelope and level trigger simultaneously Transient recorder runs simultaneously with general and waveform recorder Set & go transient setup; predefined setup (low and high level) for current and voltage trigger	
<b>General</b>		
Display	4.3 inch color TFT (480 x 272)	
Communication	USB, Ethernet	
Time synchronisation	GPS receiver (A 1355)	
Power supply	With power supply adapter or 6 x NiMH rechargeable batteries, size AA	
Overvoltage category	CAT IV / 600 V For three phase connection CAT III / 1000 V	
Weight	1,1 kg	
Dimensions	230 x 140 x 80 mm	

### STANDARD SET

#### MI 2893 Standard set (ST)

- Instrument Power Master XT
- Test probe, (brown, black, grey, green, blue), 5 pcs
- Crocodile clip, (brown, black, grey, green, blue), 5 pcs
- Voltage measurement lead, (brown, black, grey, green, blue), 5 pcs
- Labels for colour coding
- Temperature probe
- microSD memory card 8.0GB
- microSD card reader
- PC SW PowerView3
- USB and Ethernet patch cable
- Power supply adapter

- 1.2 V NiMH rechargeable battery, 6 pcs
- Professional protective waterproof case (A 1685)
- Instruction manual
- Calibration certificate

#### MI 2893 Euro set (EU)

- MI 2893 ST
- With 1-phase flexible current clamps 3000 / 300 / 30 A (A 1227), 4 pcs

#### MI 2893 Advanced set (AD)

- MI 2893 ST
- With 1-phase flexible current clamps 3000 / 300 / 30 A (A 1502), 4 pcs



Picture of MI 2893 AD set

# Power Quality Analysers

## MI 2892 Power Master



The MI 2892 Power Master is a hand-held three phase power quality analyser with a large easy-to-read graphical colour display enabling the user to detect harmonics, phasors and waveform anomalies in the installation simply by connecting the device. The instrument is designed for a long term recording as well as for troubleshooting power quality problems in three-phase and single-phase power distribution systems. The handy Quick Set buttons makes the instrument more user friendly and are allowing faster data overview for troubleshooting. Advanced PC SW package PowerView3 enables detailed analysis of recorded data, direct reading from the microSD memory card, analysis of long term records and automatic creation of professional test report.

### MEASURING FUNCTIONS

- Voltage: TRMS, peak, crest factor (4-channel);
- Current: TRMS, peak, crest factor (4-channel);
- Power (active, reactive, apparent);
- Power measurements fully compliant with IEEE 1459 (active, non active, fundamental, harmonic, load unbalance) and classic (vector or arithmetic) method;
- VFD (variable frequency drive, 5 Hz - 120 Hz), 400 Hz;
- Unbalance, flicker measurement;
- Harmonic and interharmonic analysis up to 50th harmonics, THD and TDD measurement;
- Energy (active, reactive, generated, consumed);
- Capturing and recording of power supply events (shutdowns, interruptions, swells, dips);
- Inrush currents monitoring and recording;
- Waveform/inrush displaying, snapshot and recording;
- Transients recording;
- Power quality analysis according to EN 50160, IEEE 519;
- Recording up to 7 adjustable alarms;
- Temperature measurement;
- Photo-voltaic inverter efficiency measurements;
- Power factor  $\cos \phi$  and  $\text{tg } \phi$ .

### KEY FEATURES

- 4-voltage channels with wide measurement range: 0 ... 1000 Vrms (CAT III / 1000 V);
- 4-current channels with support for automatic clamp recognition and "on instrument" range selection;
- Automatic Smart Clamp detection and Smart Clamp range selection;
- Sampling frequency on transients recording 49 kSamples/sec on 8 channels simultaneously;
- Compliance with power quality standard IEC 61000-4-30 Class A;
- Complete power quality analysis according to EN 50160 including signalling and interharmonics;
- Support for microSD memory card (8-GB supplied with the instrument) up to 32GB;
- Color-coded input terminals and terminal labels to suit your application region;
- Intuitive main menu and large icons that makes the equipment very easy to navigate and configure;
- Current clamp auto range selection;
- Powerful PC SW PowerView3 enables downloading, view, analysis of recorded data and professional report creation;
- Flexible clamps (without additional power supply) are included in the Euro set;
- Remote communication via Ethernet (GPS clock synchronization - optional).

### APPLICATION

- Energy consumption optimization;
- Power quality assessment and troubleshooting in low and middle voltage electrical systems;
- Checking power correction equipment performance;
- Long-term analysis;
- Predictive maintenance;
- Verification of electrical system capacity before adding loads.

### STANDARDS

#### Safety:

- EN 61010-1

#### Measurements:

- IEC/EN 61000-4-30, Class A;
- IEC/EN 61557-12;
- IEC/EN 61000-4-7, Class I;
- IEC/EN 61000-4-15;
- EN 50160;
- IEEE 1459;
- IEEE 519

#### Electromagnetic compatibility (EMC):

- EN 61326

## TECHNICAL DATA

### FUNCTION

<b>Voltage inputs</b>	<b>AC+DC</b>	
Number of inputs	5	
Nominal voltage range (L - N)	Phase (L-N): 50 ... 1000 Vrms / Line (L-L): 50 ... 1730 Vrms	
Measuring range	10% ... 150% of nominal voltage	
Accuracy	IEC 61000-4-30 Class A, $\pm 0.1\%$ of nominal voltage,	
Sampling rate	7 kSamples per sec @ 50/60 Hz, sync with mains freq. 1.7 kSamples per sec @ VFD (5 Hz - 120 Hz) 12.2 kSamples per sec @ 400 Hz	
Mains frequency range	42,5 ... 69,0 Hz $\pm 10$ mHz 5 ... 120 Hz $\pm 10$ mHz (VFD) 335,0 ... 465,0 Hz $\pm 100$ mHz	
<b>Current inputs</b>	<b>AC+DC</b>	
Number of inputs	4	
Measuring range:		
Range 1	10.0 mVRMS ... 300.0 mVRMS $\pm 0.25\%$ URMS	
Range 2	50.0 mVRMS ... 3.000 VRMS $\pm 0.25\%$ URMS	
<b>Functions</b>	<b>Measuring range</b>	<b>Accuracy</b>
Power (P, Q, S, cos fi, PF...)	Depends on voltage and selected clamps	IEC 61557-12 Class 1
Energy	Depends on voltage and selected clamps	Active: IEC 62053-21 Class 1 Reactive: IEC 62053-23 Class 2
Harmonics (DC ... 50th) @50/60 Hz	0 ... 20% of nom. voltage	IEC 61000-4-7 Class 1
Harmonics (DC ... 13th) @400 Hz		
Harmonics (DC ... 20th) @VFD (5 - 16 Hz)		
Harmonics (DC ... 13th) @VFD (16 - 33 Hz)		
Harmonics (DC ... 5th) @VFD (33 - 120 Hz)		
Interharmonics (1 ... 50th) @ 50/60 Hz	0 ... 20% of nom. voltage	IEC 61000-4-7 Class 1
Interharmonics (1 ... 20th) @VFD (5 - 16 Hz)		
Interharmonics (1 ... 13th) @VFD (16 - 33 Hz)		
Interharmonics (1 ... 5th) @VFD (33 - 120 Hz)		
Flicker	0.2 ... 10	IEC 61000-4-15 Class F3
Mains signalling	0 ... 15% of nom. voltage	IEC 61000-4-30 Class A
Unbalance	Voltage: 0 ... 5% Current: 0 ... 20%	
Temperature	-10 ... 85 °C	$\pm 0.5$ °C
Dips, Swell	10 ... 150% of nom. voltage	$\pm 0.2\%$ of nominal voltage $\pm 1$ cycle
Interrupts	0 ... 10% of nom. voltage	$\pm 1$ cycle
<b>Recorders</b>		
Memory	8GB microSD, up to 32GB supported	
<b>General recorder</b>		
Integration period	1s ... 2h	
Recorded signals	> 1000 (voltages, currents, harmonics, power...) Minimal, maximal and average value per interval - Voltage events - Custom alarms	
Duration	> 1 year (depends on size of SD card)	
<b>Waveform recorder</b>		
Duration	Up to 60 seconds of voltage and current waveform	
Trigger	Manual, Voltage Events, Custom Alarms, voltage or current level (inrush)	
<b>Transient recorder</b>		
Sampling rate	> 49ksamples/sec	
Duration	Up to 50 cycles of voltage and current waveform	
Trigger	Manual, voltage envelope or level	
<b>General</b>		
Display	4.3 inch colour TFT (480 x 272)	
Communication	USB, Ethernet, RS-232	
Time synchronisation	GPS receiver (A 1355)	
Power supply	110 ... 240 Vac or 6 x NiMH rechargeable batteries, size AA	
Overvoltage category	CAT IV / 600 V or CAT III / 1000 V	
Weight	0,96 kg	
Dimensions	230 x 140 x 80 mm	

### STANDARD SET

#### MI 2892 Standard set (ST)

- Instrument Power Master
- Test probe, (brown, black, grey, green, blue), 5 pcs
- Crocodile clip, (brown, black, grey, green, blue), 5 pcs
- Voltage measurement lead, (brown, black, grey, green, blue), 5 pcs
- Labels for color coding
- Temperature probe
- microSD memory card 8.0GB
- microSD card reader
- PC SW PowerView3
- USB and Ethernet patch cable

- Power supply adapter
- 1.2 V NiMH rechargeable battery, 6 pcs
- Professional protective waterproof case (A 1685)
- Instruction manual
- Calibration certificate

#### MI 2892 Euro set (EU)

- MI 2892 ST
- With 1-phase flexible current clamps 3000 / 300 / 30 A (A 1227), 4 pcs

#### MI 2892 Advanced set (AD)

- MI 2892 ST
- With 1-phase flexible current clamps 3000 / 300 / 30 A (A 1502), 4 pcs



Picture of MI 2892 AD set

# Power Quality Analysers

## MI 2885 Master Q4



The MI 2885 Master Q4 is an ideal troubleshooting tool. The recorders are designed to automatically record all important data and waveforms of voltage events like Dips and Swells. In addition the user can set 7 optional triggers for capturing waveforms of selected quantities. A large easy-to-read graphical colour display enabling the user to detect harmonics, phasors and waveforms anomalies in the installation simply by connecting the device. The handy Quick Set buttons makes the instrument more user friendly and are allowing faster data overview. The instrument is designed for a long term recording as well as for troubleshooting power quality problems in three-phase and single-phase power distribution systems. Advanced PC SW package PowerView3 enables detailed analysis of recorded data, direct reading from the microSD memory card, analysis of long term records and automatic creation of professional test report.

### MEASURING FUNCTIONS

- Voltage: TRMS, peak, crest factor (4-channel);
- Current: TRMS, peak, crest factor (4-channel);
- Power (active, reactive, apparent);
- Power measurements fully compliant with IEEE 1459 (active, non active, fundamental, harmonic, load unbalance) and classic (vector or arithmetic) method;
- VFD (variable frequency drive, 5 Hz – 120 Hz), 400 Hz;
- Unbalance, flicker measurement;
- Harmonic and interharmonic analysis up to 50th harmonics, THD and THD measurement;
- Energy (active, reactive, generated, consumed);
- Capturing and recording of power supply events (shutdowns, interruptions, swells, dips);
- Inrush currents monitoring and recording;
- Waveform/inrush displaying, snapshot and recording;
- Transients recording;
- Power quality analysis according to EN 50160, IEEE 519; ;
- Recording up to 7 adjustable alarms;
- Temperature measurement;
- Photo-voltaic inverter efficiency measurements;
- Power factor  $\cos \phi$  and  $\text{tg } \phi$ .

### KEY FEATURES

- 4-voltage channels with wide measurement range: 0 ... 1000 Vrms (CAT III / 1000 V);
- 4-current channels with support for automatic clamp recognition and "on instrument" range selection;
- Automatic Smart Clamp detection and Smart Clamp range selection;
- Sampling frequency on transients recording 49 kSamples/sec on 8 channels simultaneously;
- Compliance with power quality standard IEC 61000-4-30 Class S (0.1%);
- Complete power quality analysis according to EN 50160 including signalling and interharmonics;
- Support for microSD memory card (8-GB supplied with the instrument) up to 32 GB;
- Color-coded input terminals and terminal labels to suit your application region;
- Intuitive main menu and large icons that makes the equipment very easy to navigate and configure;
- Current clamp auto range selection;
- Powerful PC SW PowerView3 enables downloading, view, analysis of recorded data and professional report creation;
- Flexible clamps (without additional power supply) are included in the Euro set;

- Remote communication via Ethernet (GPS clock synchronization - optional).

### APPLICATION

- Energy consumption optimization;
- Power quality assessment and troubleshooting in low and middle voltage electrical systems;
- Checking power correction equipment performance;
- Long-term analysis;
- Predictive maintenance;
- Verification of electrical system capacity before adding loads.

### STANDARDS

#### Safety:

- EN 61010-1

#### Measurements:

- IEC/EN 61000-4-30, Class S;
- IEC/EN 61557-12;
- IEC/EN 61000-4-7, Class I;
- IEC/EN 61000-4-15;
- EN 50160;
- IEEE 1459;
- IEEE 519

#### Electromagnetic compatibility (EMC):

- EN 61326

## TECHNICAL DATA

FUNCTION		
<b>Voltage inputs</b>	<b>AC+DC</b>	
Number of inputs	5	
Nominal voltage range (L - N)	Phase (L-N): 50 ... 1000 VRMS Line (L-L): 50 ... 1730 VRMS	
Measuring range	10% ... 150% of nominal voltage	
Accuracy	IEC 61000-4-30 Class S, $\pm 0.1\%$ of nominal voltage,	
Sampling rate	7 kSamples per sec @ 50/60 Hz, sync with mains freq. 1.7 kSamples per sec @ VFD (5 Hz - 120 Hz)	
Mains frequency range	12.2 kSamples per sec @ 400 Hz 42,5 ... 69,0 Hz $\pm 10$ mHz 5 ... 120 Hz $\pm 10$ mHz (VFD) 335,0 ... 465,0 Hz $\pm 100$ mHz	
<b>Current inputs</b>	<b>AC+DC</b>	
Number of inputs	4	
Measuring range:		
Range 1	10.0 mVRMS ... 300.0 mVRMS $\pm 0.25\%$ URMS	
Range 2	50.0 mVRMS ... 3.000 VRMS $\pm 0.25\%$ URMS	
<b>Functions</b>	<b>Measuring range</b>	<b>Accuracy</b>
Power (P, Q, S)	Depends on voltage and selected clamps	IEC 61557-12 Class 1
Energy	Depends on voltage and selected clamps	Active: IEC 62053-21 Class 1 Reactive: IEC 62053-23 Class 2
Harmonics (DC ... 50th) @50/60 Hz	0 ... 20% of nom. voltage	IEC 61000-4-7 Class 1
Harmonics (DC ... 20th) @VFD (5 - 16 Hz)		
Harmonics (DC ... 13th) @VFD (16 - 33 Hz)		
Harmonics (DC ... 5th) @VFD (33 - 120 Hz)		
Interharmonics (1 ... 50th) @ 50/60 Hz	0 ... 20% of nom. voltage	IEC 61000-4-7 Class 1
Interharmonics (1 ... 20th) @VFD (5 - 16 Hz)		
Interharmonics (1 ... 13th) @VFD (16 - 33 Hz)		
Interharmonics (1 ... 5th) @VFD (33 - 120 Hz)		
Flicker	0.2 ... 10	IEC 61000-4-15 Class F3
Mains signalling	0 ... 15% of nom. voltage	IEC 61000-4-30 Class S
Unbalance	Voltage: 0 ... 5% Current: 0 ... 20%	
Temperature	-10 ... 85 °C	$\pm 0.5$ °C
Dips, Swell	10 ... 150% of nom. voltage	$\pm 0.2\%$ of nominal voltage $\pm 1$ cycle
Interrupts	0 ... 10% of nom. voltage	$\pm 1$ cycle
<b>Recorders</b>		
Memory	8GB microSD, up to 32GB supported	
<b>General recorder</b>		
Integration period	1s ... 2h	
Recorded signals	> 1000 (voltages, currents, harmonics, power...) Minimal, maximal and average value per interval - Voltage events - Custom alarms	
Duration	> 1 year (depends on size of SD card)	
<b>Waveform recorder</b>		
Duration	Up to 60 seconds of voltage and current waveform	
Trigger	Manual, Voltage Events, Custom Alarms, Voltage or current level (inrush), Time interval	
<b>Transient recorder</b>		
Sampling rate	> 49ksamples/sec	
Duration	Up to 50 cycles of voltage and current waveform	
Trigger	Manual, voltage envelope or level	
<b>General</b>		
Display	4.3 inch color TFT (480 x 272)	
Communication	USB, Ethernet	
Time synchronisation	GPS receiver (A 1355)	
Power supply	110 ... 240 Vac or 6 x NiMH rechargeable batteries, size AA	
Overvoltage category	CAT IV / 600 V or CAT III / 1000 V	
Weight	0,96 kg	
Dimensions	230 x 140 x 80 mm	

### STANDARD SET

#### MI 2885 Standard set (ST)

- Instrument Power Q4
- Test probe, (brown, black, grey, green, blue), 5 pcs
- Crocodile clip, (brown, black, grey, green, blue), 5 pcs
- Voltage measurement lead, (brown, black, grey, green, blue), 5 pcs
- Labels for color coding
- microSD memory card 8.0GB
- microSD card reader
- PC SW PowerView3
- USB and Ethernet patch cable
- Power supply adapter

- 1.2 V NiMH rechargeable battery, 6 pcs
- Soft carrying bag
- Instruction manual
- Calibration certificate

#### MI 2885 Euro set (EU)

- MI 2885 ST
- With 1-phase flexible current clamps 3000 / 300 / 30 A (A 1227), 4 pcs

#### MI 2885 Advanced set (AD)

- MI 2885 ST
- With 1-phase flexible current clamps 3000 / 300 / 30 A (A 1502), 4 pcs



Picture of MI 2885 AD set

# Power Quality Analysers

## MI 2884 Energy Master XA



The MI 2884 Energy Master XA is a hand-held three phase power quality analyser, specially designed for energy logging detection of harmonics, phasors and waveforms anomalies in the installation simply by connecting the device. Reducing energy use reduces energy costs and may result in a financial cost saving. Energy Master XA serves as a perfect tool for long term recording and later post processing of recorded data. Large easy-to-read graphical colour display enabling the user on site analysis and data checks. The handy Quick Set buttons makes the instrument more user friendly and are allowing faster data overview. Advanced PC SW package PowerView3 enables detailed analysis of recorded data, direct reading from the microSD memory card, analysis of long-term records and automatic creation of professional test report.

### MEASURING FUNCTIONS

- Voltage: TRMS, peak, crest factor (3-channel);
- Current: TRMS, peak, crest factor (4-channel);
- Power (active, reactive, apparent);
- Power measurements fully compliant with IEEE 1459 (active, non active, fundamental, harmonic, load unbalance) and classic (vector or arithmetic) method;
- Unbalance, flicker measurement;
- Harmonic and interharmonic analysis up to 50th harmonics, THD and TDD measurement;
- Energy (active, reactive, generated, consumed);
- Capturing and recording of power supply events (shutdowns, interruptions, swells, dips);
- Inrush currents monitoring and recording;
- Waveform/inrush displaying, snapshot and recording;
- Transients recording;
- Power quality analysis according to EN 50160, IEEE 519;
- Recording up to 7 adjustable alarms;
- Temperature measurement;
- Power factor  $\cos \phi$  and  $\text{tg } \phi$ .

### KEY FEATURES

- 3-voltage channels with wide measurement range: 0 ... 1000 Vrms (CAT III / 1000 V);
- 4-current channels with support for automatic clamp recognition and "on instrument" range selection;
- Automatic Smart Clamp detection and Smart Clamp range selection;
- Sampling frequency on transients recording 30 kSamples/sec;
- Compliance with power quality standard IEC 61000-4-30 Class S;
- Complete power quality analysis according to EN 50160 including signalling and interharmonics;
- Support for microSD memory card (8-GB supplied with the instrument) up to 32GB;
- Color-coded input terminals and terminal labels to suit your application region;
- Intuitive main menu and large icons that makes the equipment very easy to navigate and configure;
- Current clamp auto range selection;
- Powerful PC SW PowerView3 enables downloading, view, analysis of recorded data and professional report creation;
- Flexible clamps (without additional power supply) are included in the Euro set.

### APPLICATION

- Energy consumption optimization;
- Power quality assessment and troubleshooting in low and middle voltage electrical systems;
- Checking power correction equipment performance;
- Long-term analysis;
- Predictive maintenance;
- Verification of electrical system capacity before adding loads.

### STANDARDS

#### Safety:

- EN 61010-1

#### Measurements:

- IEC/EN 61000-4-30, Class S;
- IEC/EN 61557-12;
- IEC/EN 61000-4-7, Class I;
- IEC/EN 61000-4-15;
- EN 50160;
- IEEE 1459;
- IEEE 519

#### Electromagnetic compatibility (EMC):

- EN 61326

## TECHNICAL DATA

FUNCTION		
<b>Voltage inputs</b>	<b>AC+DC</b>	
Number of inputs	4	
Nominal voltage range (L – N)	Phase (L-N): 50 ... 1000 VRMS Line (L-L): 50 ... 1730 VRMS	
Measuring range	10% ... 150% of nominal voltage	
Accuracy	IEC 61000-4-30 Class S, $\pm 0.2\%$ of nominal voltage,	
Sampling rate	7 kSamples per sec @ 50/60 Hz, sync with mains freq.	
Mains frequency range	42,5 ... 69,0 Hz $\pm 10$ mHz	
<b>Current inputs</b>	<b>AC+DC</b>	
Number of inputs	4	
Measuring range:		
Range 1	10.0 mVRMS ... 300.0 mVRMS $\pm 0.5\%$ URMS	
Range 2	50.0 mVRMS ... 3.000 VRMS $\pm 0.5\%$ URMS	
<b>Functions</b>	<b>Measuring range</b>	<b>Accuracy</b>
Power (P, Q, S)	Depends on voltage and selected clamps	IEC 61557-12 Class 2
Energy	Depends on voltage and selected clamps	Active: IEC 62053-21 Class 2 Reactive: IEC 62053-23 Class 3
Harmonics (DC ... 50th)	0 ... 20% of nom. voltage	IEC 61000-4-7 Class 1
Interharmonics (1 ... 50th)	0 ... 20% of nom. voltage	IEC 61000-4-7 Class 1
Flicker	0.2 ... 10	IEC 61000-4-15 Class F3
Mains signalling	0 ... 15% of nom. voltage	IEC 61000-4-30 Class S
Unbalance	Voltage: 0.5 ... 5.0% Current: 0.0 ... 20%	
Temperature	-10 ... 85 °C	$\pm 0.5$ °C
Dips, Swell	10 ... 150% of nom. voltage	$\pm 0.2\%$ of nominal voltage $\pm 1$ cycle
Interrupts	0 ... 10% of nom. voltage	$\pm 1$ cycle
<b>Recorders</b>		
Memory	8GB microSD, up to 32GB supported	
<b>General recorder</b>		
Integration period	1s ... 2h	
Recorded signals	> 1000 (voltages, currents, harmonics, power...) Minimum, maximum, average and average ON value - Voltage events - Custom alarms	
Duration	> 1 year (depends on size of SD card)	
<b>Waveform recorder</b>		
Duration	Up to 60 seconds of voltage and current waveform	
Trigger	Manual, Voltage Events, Custom Alarms, voltage or current level (inrush)	
<b>Transient recorder</b>		
Sampling rate	30ksamples/sec	
Duration	Up to 50 cycles of voltage and current waveform	
Trigger	Manual, voltage envelope or level	
<b>General</b>		
Display	4.3 inch color TFT (480 x 272)	
Communication	USB	
Power supply	110 ... 240 Vac or 6 x NiMH rechargeable batteries, size AA	
Overvoltage category	CAT IV / 600 V or CAT III / 1000 V	
Weight	0,96 kg	
Dimensions	230 x 140 x 80 mm	

### STANDARD SET

#### MI 2884 Standard set (ST)

- Instrument Energy Master XA
- Test probe, (brown, black, grey, blue), 4 pcs
- Crocodile clip, (brown, black, grey, blue), 4 pcs
- Voltage measurement lead, (brown, black, grey, blue), 4 pcs
- Labels for color coding
- microSD memory card 8.0GB
- microSD card reader
- PC SW PowerView3
- USB cable
- Power supply adapter

- 1.2 V NiMH rechargeable battery, 6 pcs
- Soft carrying bag
- Instruction manual
- Calibration certificate

#### MI 2884 Euro set (EU)

- MI 2884 ST
- With 1-phase flexible current clamps 3000 / 300 / 30 A (A 1227), 3 pcs

#### MI 2884 Advanced set (AD)

- MI 2884 ST
- With 1-phase flexible current clamps 3000 / 300 / 30 A (A 1502), 4 pcs



Picture of MI 2884 EU set

# Power Quality Analysers

## MI 2883 Energy Master



The MI 2883 Energy Master is a hand-held three phase power quality analyser, specially designed for energy logging and subsequently efficiency calculation. Reducing energy use reduces energy costs and may result in a financial cost saving. Energy Master serves as a perfect tool for long term logging and later post processing of recorded data. Large easy-to-read graphical colour display enabling the user on site analysis and data checks. The handy Quick Set buttons makes the instrument more user friendly and are allowing faster data overview. Advanced PC SW package PowerView3 enables detailed analysis of recorded data, direct reading from the microSD memory card, analysis of long term records and automatic creation of professional test report.

### MEASURING FUNCTIONS

- Voltage: TRMS, peak, crest factor (3-channel);
- Current: TRMS, peak, crest factor (4-channel);
- Power (active, reactive, apparent);
- Power measurements fully compliant with IEEE 1459 (active, non active, fundamental, harmonic, load unbalance) and classic (vector or arithmetic) method;
- Unbalance, flicker measurement;
- Harmonic and interharmonic analysis up to 50th harmonics THD and TDD measurement;
- Energy (active, reactive, generated, consumed);
- Capturing and recording of power supply events (shutdowns, interruptions, swells, dips);
- Power quality analysis according to EN 50160;
- Recording up to 7 adjustable alarms;
- Temperature measurement;
- Power factor  $\cos \phi$  and  $\tan \phi$ .

### KEY FEATURES

- 3-voltage channels with wide measurement range: 0 ... 1000 Vrms (CAT III / 1000 V);
- 4-current channels with support for automatic clamp recognition and "on instrument" range selection;
- Automatic Smart Clamp detection and Smart Clamp range selection;
- Compliance with power quality standard IEC 61000-4-30 Class S;
- Complete power quality analysis according to EN 50160 including signalling and interharmonics;
- Support for microSD memory card (8-GB supplied with the instrument) up to 32GB;
- Color-coded input terminals and terminal labels to suit your application region;
- Intuitive main menu and large icons that makes the equipment very easy to navigate and configure;
- Current clamp auto range selection;
- Powerful PC SW PowerView3 enables downloading, view, analysis of recorded data and professional report creation;
- Flexible clamps (without additional power supply) are included in the Euro set.

### APPLICATION

- Energy consumption optimization;
- Checking power correction equipment performance;
- Long-term analysis;
- Predictive maintenance;
- Verification of electrical system capacity before adding loads.

### STANDARDS

#### Safety:

- EN 61010-1

#### Measurements:

- IEC/EN 61000-4-30, Class S;
- IEC/EN 61557-12;
- IEC/EN 61000-4-7, Class I;
- IEC/EN 61000-4-15;
- EN 50160;
- IEEE 1459;
- IEEE 519

#### Electromagnetic compatibility (EMC):

- EN 61326



## TECHNICAL DATA

FUNCTION		
<b>Voltage inputs</b>	<b>AC+DC</b>	
Number of inputs	4	
Nominal voltage range (L – N)	Phase (L-N): 50 ... 1000 VRMS Line (L-L): 50 ... 1730 VRMS	
Measuring range	10% ... 150% of nominal voltage	
Accuracy	IEC 61000-4-30 Class S, $\pm 0.2\%$ of nominal voltage,	
Sampling rate	7 kSamples per sec @ 50/60 Hz, sync with mains freq.	
Mains frequency range	42,5 ... 69,0 Hz $\pm 10$ mHz	
<b>Current inputs</b>	<b>AC+DC</b>	
Number of inputs	4	
Measuring range:		
Range 1	10.0 mVRMS ... 300.0 mVRMS $\pm 0.5\%$ URMS	
Range 2	50.0 mVRMS ... 3.000 VRMS $\pm 0.5\%$ URMS	
<b>Functions</b>	<b>Measuring range</b>	<b>Accuracy</b>
Power (P, Q, S)	Depends on voltage and selected clamps	IEC 61557-12 Class 2
Energy	Depends on voltage and selected clamps	Active: IEC 62053-21 Class 2 Reactive: IEC 62053-23 Class 3
Harmonics (DC ... 50th)	0 ... 20% of nom. voltage	IEC 61000-4-7 Class 1
Interharmonics (1 ... 50th)	0 ... 20% of nom. voltage	IEC 61000-4-7 Class 1
Flicker	0.2 ... 10	IEC 61000-4-15 Class F3
Mains signalling	0 ... 15% of nom. voltage	IEC 61000-4-30 Class S
Unbalance	Voltage: 0.5 ... 5.0% Current: 0.0 ... 20%	
Temperature	-10 ... 85 °C	$\pm 0.5$ °C
Dips, Swell	10 ... 150% of nom. voltage	$\pm 0.2\%$ of nominal voltage $\pm 1$ cycle
Interrupts	0 ... 10% of nom. voltage	$\pm 1$ cycle
<b>Recorders</b>		
Memory	8GB microSD, up to 32GB supported	
<b>General recorder</b>		
Integration period	1s ... 2h	
Recorded signals	> 1000 (voltages, currents, harmonics, power...) Minimum, maximum, average and average ON value - Voltage events - Custom alarms	
Duration	> 1 year (depends on size of SD card)	
<b>General</b>		
Display	4.3 inch color TFT (480 x 272)	
Communication	USB	
Power supply	110 ... 240 Vac or 6 x NiMH rechargeable batteries, size AA	
Overvoltage category	CAT IV / 600 V or CAT III / 1000 V	
Weight	0,96 kg	
Dimensions	230 x 140 x 80 mm	

### STANDARD SET

#### MI 2883 Standard set (ST)

- Instrument Energy Master
- Test probe, (brown, black, grey, blue), 4 pcs
- Crocodile clip, (brown, black, grey, blue), 4 pcs
- Voltage measurement lead, (brown, black, grey, blue), 4 pcs
- Labels for color coding
- microSD memory card 8.0GB
- microSD card reader
- PC SW PowerView3
- USB cable
- Power supply adapter

- 1.2 V NiMH rechargeable battery, 6 pcs
- Soft carrying bag
- Instruction manual
- Calibration certificate

#### MI 2883 Euro set (EU)

- MI 2883 ST
- With 1-phase flexible current clamps 3000 / 300 / 30 A (A 1227), 3 pcs

#### MI 2883 Advanced set (AD)

- MI 2883 ST
- With 1-phase flexible current clamps 3000 / 300 / 30 A (A 1502), 4 pcs



Picture of MI 2883 AD set

# Power Quality Analysers

## A 1685 / A 1565 / A 1577 Professional protective waterproof case



Extreme atmospheric conditions can wreak havoc on even the sturdiest of instruments, especially if left unprotected for some time. Still, many testing and measuring situations take place in outdoor environments, where there could be few appropriate shelters or the measured application itself is exposed to the weather. Power quality analysis or more specifically long-term recording of power parameters is one such example as it is performed over a longer period of time and often in more demanding environments. For such situations and for our line power quality analysers, we have developed the A 1565 Waterproof case for outdoor application and recordings (pylons, switchyards).

### A 1685 - PROFESSIONAL WATERPROOF TRANSPORT CASE

A 1685 Professional protective waterproof case is used for storing and suitable for easy transfer of PQA instrument and all accessories needed on the testing field, like:

- A 1479 wide range power supply
- A 1355 GPS receiver

A 1685 Professional protective waterproof carrying case, rated as an IP67, made from high-impact polypropylene. It has an automatic pressure equalization valve to ensure easy opening after altitude or temperature changes as well as a lock to discourage potential theft. The inside is

Dimensions: 464 x 366 x 176 mm

Net weight: 3.0 kg

Temp. resistant: -30 ... 90 °C



- Optional flexible or iron current clamps
- Additional batteries, test voltage leads, crocodiles, test probes, storage devices, card reader, SD memory card
- All optional accessories including optional current clamps

covered in soft, pliant foam with cut-out compartments for the PQA instrument and all necessary accessories. Tough, yet lightweight, and entirely waterproof, this hard protective carrying case offer premium protection of Power Quality instruments.

**Note:** by default, A 1685 case does not include any equipment. The contents of the suitcase should be agreed with the sales representative.

## A 1565 - PROFESSIONAL WATERPROOF TRANSPORT CASE FOR OUTDOOR INSTALLATION

A 1565 Waterproof case for outdoor application and recordings (pylons, switchyards), enabling installation of:

- PQA instrument
- A 1479 Wide range power supply
- A 1622 3G/Wi-Fi router
- A 1355 GPS receiver
- A 1227 Flexible current clamps



The inside is covered in soft, pliant foam with cut-out compartments for the PQA instrument and with wide range power supply A 1479, 3G/WiFi-Router A 1622 and a GPS receiver A 1355. The case includes standard voltage measurement cables for all voltage connections and 4 current probe adapter current clamps.

Dimensions: 420x 325x 250 mm  
Net weight: 4.0 kg

Overvoltage category:  
CAT IV / 600 V or  
CAT III / 1000 V

Temp. resistant: -30 ... 80 °C



A 1565 Waterproof, portable case, rated as an IP 65, made from high-impact polypropylene intended for outdoor pylon installation of PQA instruments. This portable lockable case is intended to be used in combination with PQA instruments. It has an automatic pressure equalization valve to insure easy opening after altitude or temperature changes as well as a lock to discourage potential theft.

To facilitate even greater level of protection on the A 1565 model, the connection leads, including current clamps, for the instrument are integrated into the case itself and extend to the lid mounted bag with enough additional room for current clamps and other miscellaneous accessories. For installation of pylons, the case has two suspension rings on the back, through which lanyards can be threaded.

**Note:** A 1565 case includes voltage test leads and requested current clamps. Other optional equipment (accessories) should be agreed with the sales representative.

## A 1577 - PROFESSIONAL WATERPROOF TRANSPORT CASE WITH TELESCOPIC HANDLE AND WHEELS

A 1577 Professional protective waterproof case is designed for storing and suitable for easy transfer of PQA instrument and all accessories needed on the testing field, like:

- A 1479 wide range power supply
- A 1753 4G/Wi-Fi router
- A 1355 GPS receiver
- Optional flexible or iron current clamps



from high-impact polypropylene. It has an automatic pressure equalization valve to insure easy opening after altitude or temperature changes as well as a lock to discourage potential theft. The inside is covered in soft, pliant foam with cut-out compartments for the PQA instrument and much more available and organized space for additional accessories.

Dimensions: 610 x 430 x 265 mm  
Net weight: 6.8 kg  
Temp. resistant: -30 ... 80 °C



- Additional batteries, test voltage leads, crocodiles, test probes, storage devices, card reader, SD memory card
- All optional accessories including optional current clamps

A 1577 Professional protective waterproof carrying case, rated as an IP67, made

Case is equipped with a telescopic handle and smooth-running wheels for easiest transport and offers excellent mobile protection for all of your equipment. Tough, yet lightweight, and entirely waterproof, this hard protective carrying case offer premium protection of Power Quality instruments.

**Note:** by default, A 1577 case does not include any equipment. The contents of the suitcase should be agreed with the sales representative.

# Other instruments / adapters / accessories

## CS 2890 Power Calibrator / Simulator



The CS 2890 Power Calibrator/Simulator is handheld multifunction four-phase instrument intended for calibrating and adjusting Metrel Power Quality Class A and Class S instruments as well as simulation of typical voltages and current power quality phenomena's and situations on electrical network.

### GENERAL

- Simple and powerful waveform generator with various settings.
- 4 voltage channels with wide simulation range: up to 350 Vrms.
- 4 current channels with current clamps simulation up to 2000 A.
- Simultaneous voltage and current (8 channels) simulation, 16-bit Digital to Analogue conversion for accurate signal generation.
- Saving current system settings on power off.
- 4.3" TFT colour display.
- Calibration of METREL Class A and Class S Power Quality devices.
- Adjustment of METREL Class A and Class S Power Quality devices.
- Training purposes.
- Demonstration of PQA testing equipment by sales personnel.
- Education of power quality phenomena.

### POWER SIMULATOR

- Dip, swell, interrupt, signalling, transient and inrush events simulation.
- Voltage and current harmonics waveform simulation.
- Unbalanced voltage and current waveform simulation.
- Square flicker simulation.
- Various character load/character type (inductive/capacitive) combination simulation.
- Thorough signal parameters settings.
- Programming event occurrence (key, manual, periodically, random).
- Voltage, Current, Frequency;
- Harmonics, Phase angle, Phase sequence, Unbalance (U,I);

### CALIBRATOR

- Calibration of METREL power quality devices Class A (MI 2893, MI 2892) and Class S (MI 2885, MI 2883) - predefined calibration points, related to the tested instruments.

### ADJUSTMENT

- Adjustment of METREL power quality devices Class A (MI 2893, MI 2892) and Class S (MI 2885, MI 2883).

### KEY FEATURES CALIBRATOR/ADJUSTMENT

- Voltage/current stability in the predefined calibration/adjustment points better than  $\pm 0.06\%$  under prescribed environmental conditions.
- Fine adjustment of calibration points with substandard volt-meter control measurements.

### STANDARDS

#### Safety:

- EN 61010-1: 2010

#### Electromagnetic compatibility (EMC):

- EN 61326-2-2: 2013

## TECHNICAL SPECIFICATION - CALBRATOR

Warmup time	Minimum 30 minutes, connection to external power supply is obligatory
Settling time	Less than 10 seconds
Reference temperature	23 °C ± 2 °C
Voltage/current stability	±0.1% referred to U <sub>nom</sub> = 230 V
Calibration currents	0.05 – 0.1 – 0.2 – 1 – 2 V
Calibration voltages	5-11-14-23-50-75-110-150-165-206-230-250-345-400-500 V
Frequency	50 Hz / 60 Hz
Uncertainty / 90 days	± 0.06%
Setup resolution (under Adjustment menu)	0.0001 V

## TECHNICAL SPECIFICATION - SIMULATOR

Fundamental RMS voltage output			
Output voltage AC	Resolution	Accuracy	
50 ... 350 V	10 V	± 0.1 %	
Event RMS voltage output			
Output voltage AC	Resolution	Accuracy	
0 ... 350 V	0.01 V	± 2%	
Fundamental RMS current			
Range	Output voltage	Overall current accuracy	
A 1033 (1 A ... 2000 A)	1 mV ... 1 V	±0.1 %	
Inrush RMS current output			
Inrush current	Accuracy	Crest factor	
Range 1: 2.0 mVRMS ... 200.0 mVRMS	± 0.5 % · URMS	1.5	
Range 2: 20.0 mVRMS ... 2.0000 VRMS	± 0.5 % · URMS	1.5	
Frequency			
Output range	Resolution	Accuracy	
45 Hz ... 70 Hz	1 Hz	± 10 mHz	
Flickers			
Flicker type	Measuring range	Resolution	Accuracy*
Pst	0.5 ... 5.0	0.1	± 1 %
Voltage harmonics			
Measuring range	Resolution	Accuracy	
U <sub>hn</sub> 1 % ... 100 % of fundamental output voltage	1 %	± 5 % of U <sub>hn</sub>	
U <sub>hn</sub> :	generated harmonic voltage		
n:	harmonic component 2nd ... 50th		
Current harmonics and THD			
Measuring range	Resolution	Accuracy	
I <sub>hn</sub> 1 % ... 100 % of fundamental current	1 %	± 5 % of I <sub>hn</sub>	
I <sub>hn</sub> :	measured harmonic current		
n:	harmonic component 2th ... 50th		
Unbalance			
Unbalance range	Resolution	Accuracy	
u-	0.5 % ... 5.0 %	0.1 %	± 0.15 %
u0			
i-	0.0 % ... 20 %	0.1 %	± 1 %
i0			
Overdeviation and Underdeviation			
Measuring range	Resolution	Accuracy	
U <sub>Over</sub>	0 ... 50 % UNom	0.001 %	± 0.15 %
U <sub>Under</sub>	0 ... 90 % UNom	0.001 %	± 0.15 %
Event duration and recorder time-stamp and uncertainty			
Measuring Range	Resolution	Error	
Event Duration	10 ms ... 7 days	1 ms	± 1 cycle
Event Duration (Signaling)	1 s ... 100 s	100 ms	
Record and Event Time stamp	N/A	1 ms	± 1 cycle
General			
Measuring category	CAT I / 300 V		
Dimensions	230 x 140 x 80 mm		
Weight (with batteries)	1,36 kg		
Display	Colour 4.3 TFT liquid crystal display (LCD) with backlight, 480 x 272 dots.		
Batteries	6 x 1.2 V NiMH rechargeable batteries type HR 6 (AA)		
Working temperature range	0 °C ... +40 °C		

### STANDARD SET

#### CS 2890











- Instrument Power Calibrator/Simulator
- Voltage measurement lead, (brown, black, grey, green, blue), 5 pcs
- Special power supply cable for voltage offset measurement
- Current measurement leads, 4pcs
- Labels for colour coding
- Power supply adapter
- 1.2 V NiMH rechargeable battery, 6 pcs

- Soft carrying bag
- USB cable
- Instruction manual
- Calibration certificate













Picture of CS 2890 set









# Selection Guide for PQA Accessories

Photo	Part number	Description	Target application	MI 2893	MI 2892	MI 2885	MI 2883/84
	A 1501	1-phase mini flexible current clamp 3000/300/30 A / 1V	Single phase smart flexible current clamp with three selectable measuring ranges (Sensor length: 25 cm; max. conductor size: 70 mm). Does not require external power supply as it is powered by the measuring instrument.	•	•	•	•
	A 1502	1-phase mini flexible current clamp 3000/300/30 A / 1V	Single phase smart flexible current clamp with three selectable measuring ranges (Sensor length: 48 cm; max. conductor size: 140 mm). Does not require external power supply as it is powered by the measuring instrument.	•	•	•	•
	A 1609	1-phase mini flexible current clamp 3000/300/30 A / 1V	Single phase smart flexible current clamp with three selectable measuring ranges (Sensor length: 175 cm; max. conductor size: 540 mm). Does not require external power supply as it is powered by the measuring instrument.	•	•	•	•
	A 1503	1-phase mini flexible current clamp 6000/600/60 A / 1V	Single phase smart flexible current clamp with three selectable measuring ranges (Sensor length: 90 cm; max. conductor size: 270 mm). Does not require external power supply as it is powered by the measuring instrument.	•	•	•	•
	A 1227	1-phase flexible current clamp 3000/300/30 A / 1V	Single phase smart flexible current clamp with three selectable measuring ranges Sensor length: 48 cm; max. conductor size: 140 mm. Current clamp is automatically recognized by the instrument. Clamp does not require external power supply as it is powered by the measuring instrument.	•	•	•	•
	A 1445	1-phase flexible current clamp 3000/300/30 A / 1V	Single phase smart flexible current clamp with three selectable measuring ranges Sensor length: 61 cm; max. conductor size: 190 mm. Current clamp is automatically recognized by the instrument. Clamp does not require external power supply as it is powered by the measuring instrument.	•	•	•	•
	A 1446	1-phase flexible current clamp 6000/600/60 A / 1V	Single phase smart flexible current clamp with three selectable measuring ranges Sensor length: 90 cm; max. conductor size: 270 mm. Current clamp is automatically recognized by the instrument. Clamp does not require external power supply as it is powered by the measuring instrument.	•	•	•	•
	A 1582	1-phase flexible current clamp 3000/300/30 A / 1V; High temperature	Single phase, high temperature (sensor: -20 to 200 °C, module: -20 to 70 °C) smart flexible current clamp with three selectable measuring ranges. Sensor length: 61 cm; max. conductor size: 190 mm. Current clamp is automatically recognized by the instrument. Clamp does not require external power supply as it is powered by the measuring instrument.	•	•	•	•
	A 1281	Current clamp 0,5/5/100/1000 A / 1V	Four smart ranges current clamp 0,5/5/100/1000 A / 1 V, with jaw opening: 5.2 cm; Max. conductor size < 50 mm for measuring alternating currents in low and medium power installations. Current clamp is automatically recognized by the instrument. Clamp does not require external power supply as it is powered by the instrument.	•	•	•	•
	A 1588	Current clamp 0.5/5/50 A	High smart accuracy current clamp 0.5/5/50 A, Jaw opening: 40 mm; Max. conductor size < 50 mm for precise current and power measurements including leakage current measurement	•	•	•	•

• Option















Photo	Part number	Description	Target application	MI 2893	MI 2892	MI 2885	MI 2883/84
	A 1398 PQA	Current clamp 10A / 1V	Highly accurate iron current clamp for current (including leakage current) and power measurements with smart clamp technology (automatic recognition by the analyser), powered by the connected PQA, and designed for measuring alternating currents in low-power installations (up to 20 A).	•	•	•	•
	A 1391 PQA	Current clamp AC/DC 40/300 A / 1 V	AC current clamp 40/300 A / 1 V with jaw opening: 2.5 cm; Max. conductor size < 50 mm for power measurements. Battery Life, 66 hours typical (Alkaline).	•	•	•	•
	A 1636	Current clamp AC/DC 1500 A	AC/DC current clamp 1500 A, with Jaw opening: 7,3 cm; Max. conductor size < 68 mm for power measurements (photo voltaic) Battery operated (9V)	•	•	•	•
	A 1717	Current clamp AC/DC 100/1000 A / 1 V	AC/DC current clamp 100/1000A / 1V with jaw opening 51mm, max. conductor size 52 mm for power measurements (photo voltaic). Battery operated 9V, battery life with 500 mAh approx. 75 hours, 1200mAh approx. 6 1/2 days. Requires A 1561 connection cable.	•	•	•	•
	A 1037	Current transformer 5 A / 1 V	3-phase transformer for power measurements on distribution panels with 5 A nominal output current.	•	•	•	•
	S 2087	1 x Mini current clamp A 1069, 100 A / 1 V	Set of one A 1069 current clamp for power measurements, including A 1561 connection cable.	•	•	•	•
	A 1940	Marking rings 5 - 6 mm	Marking rings for marking current clamps with cable diameter between 5 - 6 mm	•	•	•	•
	A 1941	Marking rings 4 - 5 mm	Marking rings for marking current clamps with cable diameter between 4 - 5 mm	•	•	•	•
	S 2124	DC current clamp with cable adapter	100A / 1000A DC current clamp with adapter A 1561	•	•	•	•
	A 1561	Connection cable for current clamp	Connection cable for connecting current clamps A 1069 and A 1717, on Metrel power quality analysers.	•	•	•	•
	A 1354	Temperature probe	Temperature probe can be used for monitoring and recording of temperature trend at measuring objects, such as capacitors, motors, transformers, etc.	•	•	•	•

• Option





Photo	Part number	Description	Target application	MI 2893	MI 2892	MI 2885	MI 2883/84
	A 1648	Current clamp extension cable, 5 m	Extension cable for current clamps	•	•	•	•
	A 1479	Wide range power supply	Wide range power supply (Unom: 85V ÷ 650 Vac / 920 Vdc ) provide power supply for PQ device and modem directly from voltage measuring terminals. Applicable when standard electrical sockets are not available on measurement site.	•	•	•	•
	A 1778	Magnetic contact probe	The A 1778 magnetic probe (with a Ø6.6 mm right-angle magnetic adapter and a Ø4 mm socket) is designed for semi-temporary measurement of voltage on steel screw terminal blocks.	•	•	•	•
	A 1355	GPS receiver	GPS Synchronization unit for ensuring exact date & time, which guaranties that the time clock uncertainty of the Metrel power quality analyzers does not exceed ±10 ms for 50 Hz signals, according to IEC 61000-4-30.	•	•	•	
	A 1750	GPS Cable extension	Cable extension for A 1355 GPS receiver, 10 m.	•	•	•	
	A 1753	4G modem	4G modem for remote instrument access.	•	•	•	
	A 1756	Photo-scanning head	Optically sensitive device, which reads the blinking of a LED on electronic electricity meters as well as color marks on the disc of induction electricity meters. It is intended for accuracy measurement (active/reactive energy) of electronic and mechanical electricity meters.		•	•	
	A 1631	EV monitoring cable	A special accessory designed for current, voltage and CP signal, monitoring during Electric Vehicle (EV) charging process.	•	•	•	•
	A 1298	Test probe, brown	Test probe with fi 4 mm connection is suitable for performing measurements both in mains outlets and in situations when no schuko outlet is not present.	•	•	•	•
	A 1014	Test probe, black		•	•	•	•
	A 1453	Test probe, grey		•	•	•	•
	A 1015	Test probe, blue		•	•	•	•
	A 1062	Test probe, green		•	•	•	•
	A 1016	Test probe, red		•	•	•	•

• Option



Photo	Part number	Description	Target application	MI 2893	MI 2892	MI 2885	MI 2883/84
	A 1297	Crocodile clip, brown	Crocodile clip assures secure and permanent contact during the measurement on bus bars, fixing screws, etc.	•	•	•	•
	A 1013	Crocodile clip, black		•	•	•	•
	A 1547	Crocodile clip, grey		•	•	•	•
	A 1310	Crocodile clip, blue		•	•	•	•
	A 1309	Crocodile clip, green		•	•	•	•
	A 1064	Crocodile clip, red		•	•	•	•
	S 2015	Safety flat clamp, 4 pcs	Safety flat clamps assure good contact when connecting the test leads on busbars and other larger flat surfaces.	•	•	•	•
	A 1458	microSD card reader	Move data between your computer and memory card with memory card reader.	•	•	•	•
	A 1673	Micro SD card 32GB	32GB memory card to store large amount of data	•	•	•	•
	S 2072	USB storage device (for backup of data)	USB stick enables you to backup your data to a USB drive. This is a practical backup solution as it allows you to store recorded data files to external device, offering increased portability.	•	•	•	•
	A 1459	Set of measuring leads, 5 x 2m	High quality measuring leads for use up to CAT III / 1000 V.	•	•	•	
	A 1459 5M	Set of measuring leads, 5 x 5m		•	•	•	
	A 1512	Set of measuring leads, 4 x 2m		•			•
	A 1577	Professional protective waterproof case with a telescopic handle and smooth-running wheels	Professional protective waterproof carrying case with telescopic handle and smooth-running wheels, made from high-impact plastic intended for easiest transportation to testing place. Huge volume enables storage of all needed accessories. It also has an automatic pressure equalization valve to insure easy opening after altitude or temperature changes.	•	•	•	•
	A 1685	Professional protective waterproof case	Professional protective waterproof carrying case, made from high-impact plastic. It also has an automatic pressure equalization valve to insure easy opening after altitude or temperature changes. Tough, yet lightweight, and entirely waterproof, this hard protective carrying case offer premium protection of Power Quality instruments.	•	•	•	•
	A 1565	Waterproof case for outdoor application and recordings (pylons, switchyards)	Waterproof, portable case, rated as an IP 65, for outdoor application of PQ instruments. This portable lockable case is intended to be used in combination with PQA instruments. It is designed to be used with wide range power supply A 1479, 3G/WiFi-Router A 1622 and a GPS receiver A 1355. The case includes standard voltage measurement cables for all voltage connections and 4 current clamps, A 1227.	•	•	•	•

• Option

Photo	Part number	Description	Target application	MI 2893	MI 2892	MI 2885	MI 2883/84
	A 1006	Soft carrying bag	Large soft carrying bag for transport and storage of test instrument and belonging accessories.	•	•	•	•
	A 1020	Small soft carrying bag	Small soft carrying bag for transport and storage of test instrument or accessories.	•	•	•	•
	S 2125	1,2 V, 2400 mAh AA rechargeable NiMH batteries type AA, 6 pcs	A set of 6 pieces of rechargeable batteries type AA.	•	•	•	•
	A 1160	Fast charger for 8 AA batteries with a set of 6 NiMH bat., type AA	Fast battery charger for up to 8 pieces of AA rechargeable batteries, and a set of 6 pcs NiMH rechargeable batteries, type AA.	•	•	•	•

- Option

# Content

## Equipment for laboratories and Schools

Electrical Installation Safety	1.1 - 1.72
High Voltage Insulation / Continuity / Earth / Transformer	2.1 - 2.48
Appliance / Machine / Switchboard Safety	3.1 - 3.52
Power Quality Analysis	4.1 - 4.26
<b>EQUIPMENT FOR LABORATORIES AND SCHOOLS</b>	<b>5.1 - 5.16</b>
Multimeters / Clamp meters / Voltage testers / Thermal cameras	6.1 - 6.44
Software	7.1 - 7.19

### **DEMONSTRATION BOARDS**

MI 3399 Electrical Safety and Quality Application Trainer	5.02
MI 3298 P1 Earth/Ground trainer module	5.04
MI 3298 T Transformer/Insulation trainer module	5.06
MI 3088 PV Demonstration Board	5.08
MA 2067 Demonstration Board	5.09
MI 3099 Demonstration Board	5.10
MI 2166 Demonstration Board	5.11
MI 3300 Portable Appliance Simulation Board	5.12
MI 3299 HV demo BOX	5.13
MI 2891 Power Simulator	5.14

# Demonstration boards

## MI 3399 Electrical Safety & Quality Application Trainer



The MI 3399 Electrical Safety & Quality Application Trainer is a 3D simulator of real-life safety and quality situations with many adjustable risks and errors. The model is designed as a stand-alone unit for demonstrations, trainings and educational purposes. The MI 3399 is ideally suited for training and education of larger groups of people as well as for independent practice. Due to various integrated electrical elements the model enables complete testing and troubleshooting of power quality analysis as well as LV electrical installations, lightning systems, earthing systems, PV systems, appliances, equipment, machines or switchboards by using modern methods, testing procedures and instruments.

### KEY FEATURES

- Insulation resistance;
- Continuity of PE conductors;
- Line impedance;
- Loop impedance;
- RCD testing (Contact voltage, trip-out time, trip-out current, Autotest);
- IMD, ELM, RCM leakage and insulation monitors adjustment and test;
- Earth resistance (4-wire, 3-wire, 2-wire, two current clamps);
- Specific earth resistance;
- Lightning protection loops and legs resistance;
- Surge protector test;
- Leakage current;
- Phase rotation;
- Voltage;
- Frequency;
- AUTO SEQUENCE<sup>®</sup> procedure for TN, TT or IT earthing system;
- Power quality.

More than 65 different measurements and testing methods could be demonstrated all in accordance to IEC 61557 and IEC 60364-6. The most significant elements are integrated: RCDs of different types, Fuses, PE equalization bars, 1-phase and 3-phase sockets, various grounding systems (TT,

TN, IT), Surge protector, IMD insulation monitor and more.

### APPLICATION

- Trainings and seminars for gaining theoretical knowledge and for performing practical exercises;
- For conducting exams when upgrading the professional's competence level;
- Educational and practical training of electrical contractors about safety procedures, measuring methods and knowledge;
- Demonstration on how to use different measurement instruments and testers.

### MODULES AND COURSES

- LV Electrical Installation Safety Trainer Module;
- TN / TT / IT Earthing Systems Trainer Module;
- Lightning Protection Trainer, Surge Protection Trainer Module;
- Special Installations and Locations Safety Trainer Module;
- Vehicles and Mobile Units Safety Trainer Module.

### Additionally there are several optional modules available:

- Power and Voltage Quality Trainer Module;
- Appliances and Machines Safety Trainer Module;
- Photovoltaic Systems Trainer Module.

All modules are supported with Handbooks, Posters, Charts, Presentations, Exercises, Catalogue of Knowledge and Catalogue of Exams. Approved certificates may be issued when localizing modules to meet the required country's regulation.

More than 30 different errors can be simulated all of which enable the trainee to practice analysis and troubleshooting procedures.

### STANDARDS

#### Functionality

- IEC 61557

#### Safety

- IEC 60364-6

## MI 3399 APPLICATION TRAINER SET MODULES

### AD1 MI 3399 – EIS ELECTRICAL INSTALLATION SAFETY TRAINER

Module includes the following equipment:

- MI 3155 ST EurotestXD - Multifunctional installation tester
- MI 3110 EurotestIM - Special installation tester
- MI 3242 MicroOhm 2A - Earth bonding 4-wire
- MI 3121H Smartec 2,5 kV - HV Insulation analyser
- MI 3123 Smartec - Earth/Clamp tester
- MD 9272 Leakage clamp TRMS with Power & Harmonics
- A 1018 Current clamp (low range, leakage)
- A 1019 Current clamp
- S 2009 Test lead set, 2 m, 4 pcs
- 25 pcs Electrical Inspector's guide
- 25 pcs Chart: Verification on Low-voltage electrical installations
- Poster: Verification on Low-voltage electrical installations
- Poster: Medical sites
- Poster: Firebrigades

### AD2 MI 3399 – PQA POWER AND VOLTAGE QUALITY TRAINER

Module includes the following equipment:

- MI-2892 Power Master - Power Quality Analyser Includes also:
- Quick guide: Power Quality Analysing and troubleshooting procedures

### AD3 MI 3399 – GT APPLIANCES & MACHINES SAFETY TRAINER

Module includes the following equipment:

- MI 3309 BT DeltaGT
- A 1488 BT Able printer (with battery charger and one role of labels)
- 25 pcs Chart: Machines & switchboards safety & quality testing
- 25 pcs Chart: Portable appliances and electrical equipment testing
- Poster: Portable appliances and electrical equipment testing

### AD4 MI 3399 – PV PHOTOVOLTAIC SYSTEMS TRAINER

Module includes the following equipment:

- MI 3109 PS EurotestPV Pro Set Includes also:
- A 1378 EurotestPV Remote
- A 1391 AC/DC Current clamp
- A 1427 PV Reference cell
- A 1400 PV Temperature probe
- A 1384 PV Safety probe



# Demonstration boards

## MI 3298 P1 Earth/Ground trainer module

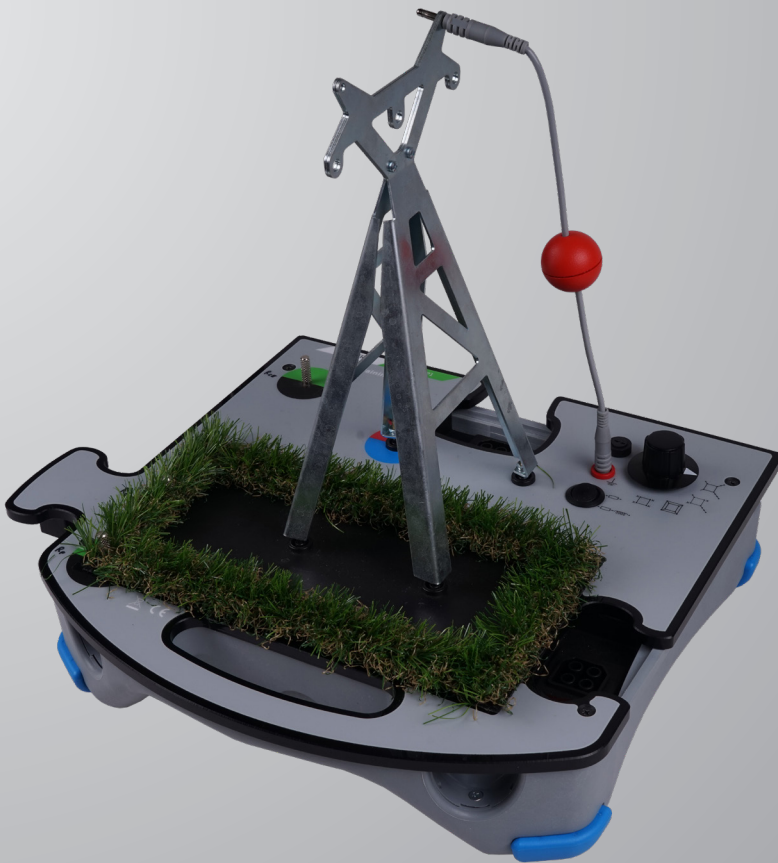

MI 3298 P1 Earth/Ground trainer module is designed as a stand-alone module for training different earth measuring methods. Due to the puzzle concept, other MI 3298 P1 Earth/Ground trainer modules and/or MI 3298 T Transformer/Insulation trainer modules can be joined together to simulate a complete transmission line with a switchyard at the end. The module also offers simulation of different errors and object states through the use of a selectable switch and ground wire.

### KEY FEATURES

- Ground networks impedance;
- Earth surface potentials;
- Fault simulated step & contact voltage;
- Pylon (selective legs);
- HF earth impedance.

Different modules can be evaluated separately as an independent system and / or connected together to demonstrate the interconnectivity problems and influences between them.

This approach could give trained personnel clear information about testing methods, measured values and results on known systems and an overview of situations where systems become more complex when connected together.

### APPLICATION

- Trainings and seminars for gaining theoretical knowledge and demonstrating/performing practical exercises;
- Conducting exams when upgrading the examined professional's competence level;
- Education and practical training of electrical contractors about safety procedures, measuring methods and general knowledge;
- Demonstration on how to use different measurement instruments and testers.

### MODULES AND COURSES

- Earth/ground network impedance analysis;
- Power generator, transformer and coils;
- Insulating material analysis.

All modules are supported with handbooks, posters, charts, presentations, exercises, catalogue of knowledge and catalogue of exams. Approved certificates may be issued when localizing modules to meet the required country's regulation.

Both training modules offer simple error simulation, thus enabling trainees to practice troubleshooting procedures.

#### MI 3298 P1 is compatible with:

- MI 3295 Step Contact Voltage Measuring System
- MI 3205 TeraOhmXA 5kV
- MI 3280 Digital Transformer Analyser
- MI 3250 MicroOhm 10A
- MI 3290 GX 1 Earth Analyser

### STANDARDS

#### Functionality

- IEC 61557-5
- IEEE Std 81-2012

#### Safety

- IEC 61010-1:2010



Different measuring procedures and methods can be demonstrated/trained on the MI 3298 P1 Earth/Ground trainer module:

- 3-pole measuring method;
- 4-pole measuring method;
- S-flex measuring method by using one or more flex clamps;
- HF measuring method;
- Impulse measuring method;
- GPR measurement;
- Step and contact voltage measurement;
- Pylon ground wire (PGW) test.

Different measuring procedures can be demonstrated/trained under various simulated errors and types of objects:

- Simulation of broken connection pylon foot resistance;
- Pylon grounding ring simulation for GPR measurements;
- Simulation of a ground wire connection;
- Simulation of different earthing types.

The MI 3298 Power Network Application Trainer (MI 3298 P1 and MI 3298 T) based on “puzzle” concept for simulation and training of different measurement situations on the high voltage field. It could be used as stand-alone training module or any numbers of training modules connected together. Training modules are designed for demonstrations, trainings and educational purposes.

The “puzzle” concept is ideally suited for training and education of larger groups of people as well as for independent practice. Due to various integrated electrical elements the module enables complete testing, troubleshooting and practice on earth, insulation measurements as well as power transformer measurements.

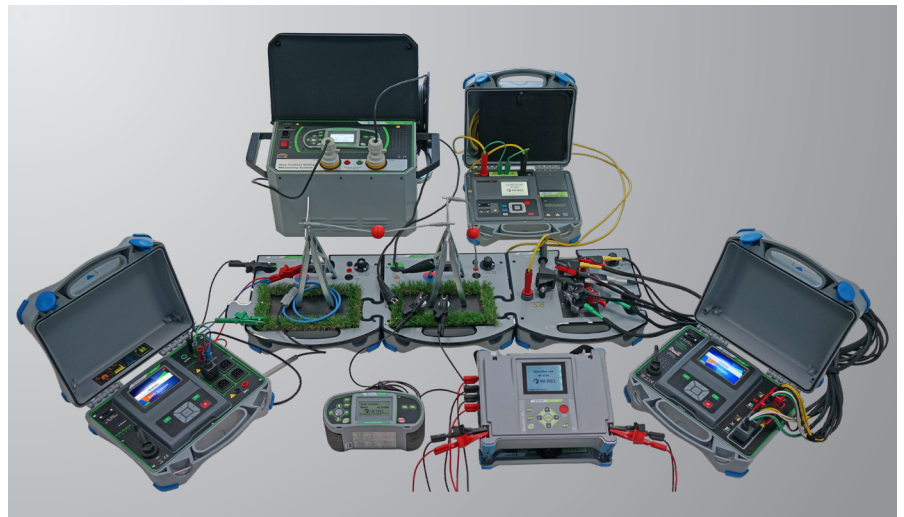

Picture of MI 3298 P1 set



#### STANDARD SET

##### MI 3298 P1

Training module includes:

- MI 3298 P1 Earth/Ground trainer module, code 20 919 237
- Step voltage probe, code 20 052 009, 2 pcs
- Pylon, code 20 052 006
- Ground wire connection, code 20 692 042
- Puzzle interconnection part, code 20 052 010
- Set of measuring cables
- Flex current clamps A 1612 (fi 14 cm), code 20 051 222
- Optional: Flex current clamps A 1612 (fi 14 cm), code 20 051 222, 3 pcs

Picture of AD1 MI 3298 set



##### AD1 MI 3298 – Earth/Transformer/Insulation Resistance Trainer

Module includes the following equipment:

- MI 3298 P1 Earth/Ground trainer module
- MI 3298 T Transformer/Insulation trainer module
- MI 3295 Step Contact Voltage Measuring System
- MI 3205 TeraOhmXA 5kV
- MI 3280 Digital Transformer Analyser
- MI 3290 GX 1 Earth Analyser

Picture of AD2 MI 3298 set

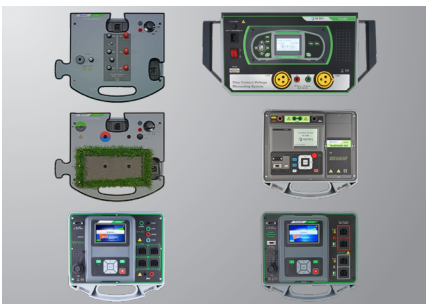

##### AD2 MI 3298 – Earth/Transformer/Insulation Resistance Trainer

Module includes the following equipment:

- MI 3298 P1 Earth/Ground trainer module
- MI 3298 T Transformer/Insulation trainer module
- MI 3295 Step Contact Voltage Measuring System
- MI 3205 TeraOhmXA 5kV
- MI 3280 Digital Transformer Analyser
- MI 3290 GX 1 Earth Analyser

Picture of AD3 MI 3298 set



##### AD3 MI 3298 – Earth Trainer

Module includes the following equipment:

- MI 3298 P1 Earth/Ground trainer module
- MI 3295 Step Contact Voltage Measuring System
- MI 3290 GX 1 Earth Analyser

# Demonstration boards

## MI 3298 T Transformer/Insulation trainer module



The MI 3298 T Transformer/Insulation trainer module is designed as a stand-alone module for training of different insulation measuring methods as well as basic measuring procedures on voltage transformers. Due to the puzzle concept, other MI 3298 P1 Earth/Ground trainer modules and/or MI 3298 T Transformer/Insulation trainer modules can be joined together to simulate a complete transmission line with a switchyard at the end. It is possible to simulate different types of errors on the transformer.

### KEY FEATURES

- Cable impedance, resistance and insulation;
- HV insulation resistance;
- Transformer impedance measurement;
- Winding resistance measurement;
- Transformer turn ration analysis.

Different measuring procedures and methods can be demonstrated/trained on the MI 3298 T Transformer/Insulation trainer module:

Insulation measurements:

- Insulation resistance test (spot test);
- Diagnostic tests (DAR, PI, DD);
- Step voltage test.

Transformer analysis:

- Transformer turn ratio measurement;
- Winding resistance measurement.

Different measuring procedures can be demonstrated/trained under various simulated errors:

- Broken windings;
- Short-circuit faults on windings.

### APPLICATION

- Trainings and seminars for gaining theoretical knowledge and demonstrating/performing practical exercises;
- Conducting exams when upgrading the examined professional's competence level;
- Education and practical training of electrical contractors about safety procedures, measuring methods and general knowledge;
- Demonstration on how to use different measurement instruments and testers.

### MODULES AND COURSES

- Earth/ground network impedance analysis;
- Power generator, transformer and coils;
- Insulating material analysis.

All modules are supported with handbooks, posters, charts, presentations, exercises, catalogue of knowledge and catalogue of exams. Approved certificates may be issued when localizing modules to meet the required country's regulation.

Both training modules offer simple error simulation, thus enabling trainees to practice troubleshooting procedures.

#### MI 3298 P1 is compatible with:

- MI 3295 Step Contact Voltage Measuring System
- MI 3205 TeraOhmXA 5kV
- MI 3280 Digital Transformer Analyser
- MI 3250 MicroOhm 10A
- MI 3290 GX 1 Earth Analyser

### STANDARDS

#### Functionality

- IEC 61557-5
- IEEE Std 81-2012

#### Safety

- IEC 61010-1:2010



The MI 3298 Power Network Application Trainer (MI 3298 P1 and MI 3298 T) based on “puzzle” concept for simulation and training of different measurement situations on the high voltage field. It could be used as stand-alone training module or any numbers of training modules connected together. Training modules are designed for demonstrations, trainings and educational purposes.

The “puzzle” concept is ideally suited for training and education of larger groups of people as well as for independent practice. Due to various integrated electrical elements the module enables complete testing, troubleshooting and practice on earth, insulation measurements as well as power transformer measurements.

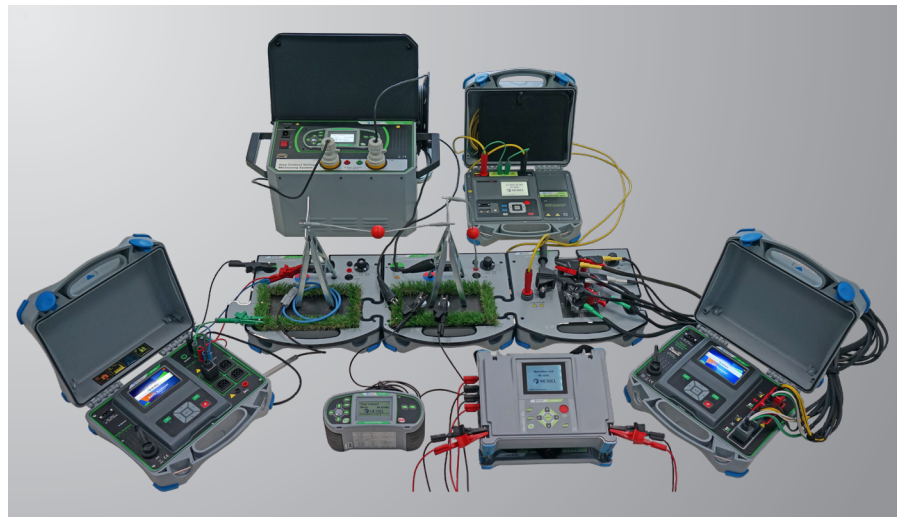

Picture of MI 3298 P1 set



#### STANDARD SET

##### MI 3298 T

Training module includes

- MI 3298 T Transformer/Insulation trainer module, code 20 919 238
- Puzzle interconnection part, code 20 052 010

Picture of AD1 MI 3298 set



#### AD1 MI 3298 – Earth/Transformer/Insulation Resistance Trainer

Module includes the following equipment:

- MI 3298 P1 Earth/Ground trainer module
- MI 3298 T Transformer/Insulation trainer module
- MI 3295 Step Contact Voltage Measuring System
- MI 3205 TeraOhmXA 5kV
- MI 3280 Digital Transformer Analyser
- MI 3290 GX 1 Earth Analyser

Picture of AD2 MI 3298 set

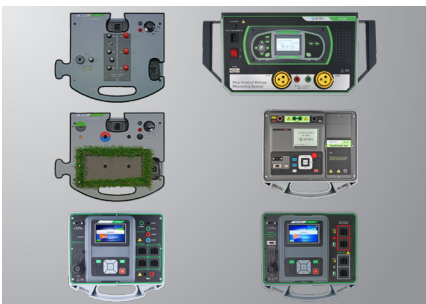

#### AD2 MI 3298 – Earth/Transformer/Insulation Resistance Trainer

Module includes the following equipment:

- MI 3298 P1 Earth/Ground trainer module
- MI 3298 T Transformer/Insulation trainer module
- MI 3295 Step Contact Voltage Measuring System
- MI 3205 TeraOhmXA 5kV
- MI 3280 Digital Transformer Analyser
- MI 3290 GX 1 Earth Analyser

Picture of AD4 MI 3298 set



#### AD4 MI 3298 – Transformer/Insulation Resistance Trainer

Module includes the following equipment:

- MI 3298 T Transformer/Insulation trainer module
- MI 3205 TeraOhmXA5 kV
- MI 3280 Digital Transformer Analyser

# Demonstration boards

## MI 3088 PV Demonstration Board



Demonstration board MI 3088 simulates typical photovoltaic (PV) system with one PV module and DC/AC inverter. It represents a typical installation that consist of PV string, DC switch box, DC/AC inverter and one phase connection to the power grid. It is intended for use preferably by sales personnel for demonstration of the measuring methods and procedures on DC and partially on AC side of a PV system.

### KEY FEATURES

- With this demo board all electrical tests according to EN 625446 can be demonstrated: continuity, isolation, open circuit voltage  $U_{oc}$ , short circuit current  $I_{sc}$  and polarity.
- It simulates an I/V characteristic of a PV module/string.
- Simulated output of the irradiance and temperature sensor.
- Simulation of a DC/AC inverter with one DC input and single phase output.

### APPLICATION

- Presentation of testing of a PV system;
- Demonstration of PV test equipment by sales personnel.

### STANDARDS

#### Functionality

- EN 62446

#### Electromagnetic compatibility

- IEC/EN 61326

#### Safety

- EN 61010 -1

### STANDARD SET

#### MI 3088

- Demonstration board
- Mains cable
- PS2 male / male adapter
- Test lead 1.5 m, black
- Test lead 1.5 m, red
- User manual

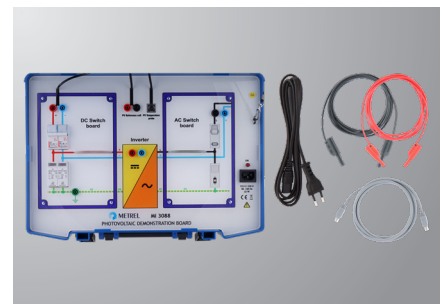

Picture of MI 3088 - set

### TECHNICAL DATA

Power supply	115 V/ 230 V, 50 Hz / 60 Hz
Overvoltage category	CAT II / 300 V
Dimensions	450 × 330 × 110 mm
Weight	4.47 kg

# Demonstration boards

## MA 2067 Demonstration Board

Demonstration Board MA 2067 is an excellent demonstration and educational tool that simulates real conditions in low voltage electrical installations. The Demonstration board consists of all significant elements of electrical installations like RCDs of different types, fuses, PE equalization bars, 1-phase and 3-phase sockets, various consumers of electrical energy and various grounding systems (TT, TN, IT). The MA 2067 Demonstration Board provides simulation of different types of faults in electro installation. Complete testing and troubleshooting of the installation is possible by using suitable instruments.

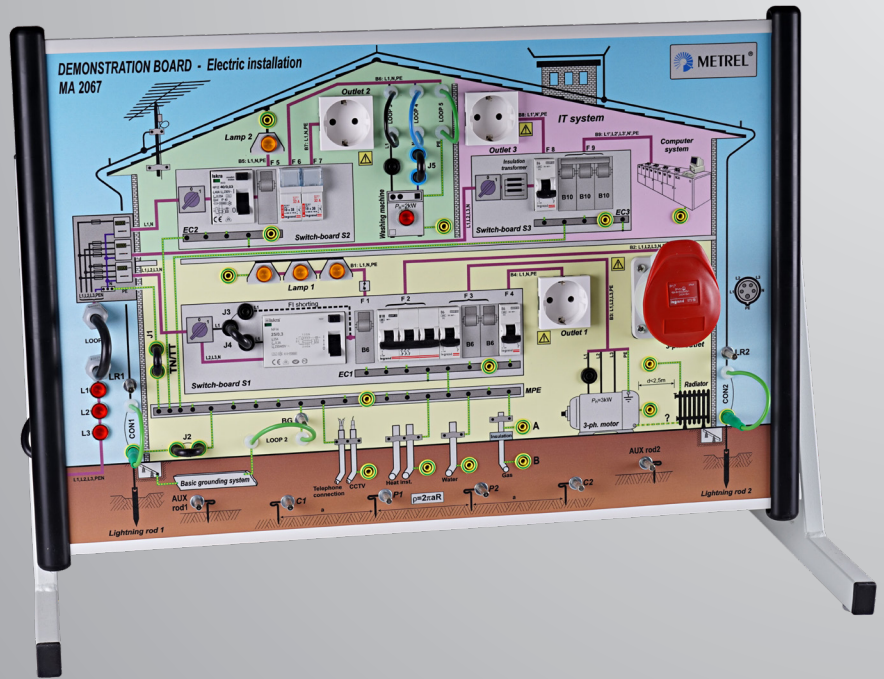

### KEY FEATURES

- 65 different measurements in accordance to EN 61557 are possible (insulation resistance, continuity of PE conductors, earth resistance, specific earth resistance, line and loop impedance, phase rotation, leakage current, RCD testing, voltage and frequency).
- 19 different errors can be selected on a lockable distributor.
- Different types of RCD are integrated for measurement of trip-out time, trip-out current and contact voltage
- Simulation of TT, TN and IT earth systems.
- Possibility of connection to single phase or 3-phase supply system.
- Booklet with theory and exercises for schools and training centres is included in a standard set.

### APPLICATION

- Education of students of electro technical specialities;
- Education and practical training of electrical contractors about measurements on low voltage electro installations;
- Demonstration on how to use different measurement instruments by sales personnel.

### STANDARDS

#### Electromagnetic compatibility

- IEC/EN 61326

#### Safety

- IEC/EN 61010 -1;

### STANDARD SET

#### MA 2067

- Demonstration board
- Jumper, 4 pcs
- Board support for vertical use
- Three phase to one phase adapter
- 1-phase mains cable
- Instruction manual
- Booklet with exercises
- Calibration certificate

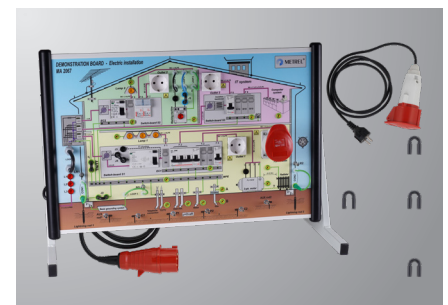

Picture of MA 2067 set

### TECHNICAL DATA

Power supply	230 V / 400 V, 50 Hz
Dimensions	680 x 450 mm (w x h)
Weight	12.5 kg

# Demonstration boards

## MI 3099 Demonstration Board



Demonstration board MI 3099 simulates typical electrical installation usually met in individual houses or apartments with important elements on switchboard and on circuit site. Demonstration board is intended for use preferably by sales personnel when demonstrating operation of electrical installation test equipment, especially the new Metrel's electrical installations safety testers with built-in AUTOSEQUENCE procedure.

### KEY FEATURES

- The board contains real elements of electrical installation like RCD, mains switch, automatic fuses, switches, lamps, 1-phase and 3-phase mains test outlet, N and PE collector.
- All standardised testing methods can be presented.
- TN or TT system with or without RCD can be simulated.
- Possibility of connection to single phase or 3-phase supply system.
- Various Autosequence test procedures are supported for demonstration of testing safety by new EurotestAT and EurotestXA.
- Demonstration board is put in the strong rugged case with a handle for comfortable carrying.

### APPLICATION

- Presentation of complete testing of any electrical installation;
- Demonstration of electrical installation test equipment operation by sales personnel.

### STANDARDS

#### Functionality

- EN 62446

#### Electromagnetic compatibility

- IEC/EN 61326

#### Safety

- EN 61010 -1

### STANDARD SET

#### MI 3099

- Demonstration board
- Jumper
- Special probe, 3 pcs
- Mains cable
- Three phase to one phase adapter
- Instruction manual
- Calibration certificate

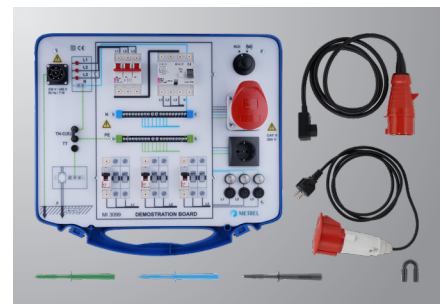

Picture of MI 3099 set

### TECHNICAL DATA

Power supply	230 V / 400 V, 50 Hz
Overvoltage category	CAT II / 300 V
Dimensions	480 × 387 × 136 mm
Weight	5 kg

# Demonstration boards

## MI 2166 Demonstration Board

Demonstration board MI 2166 simulates common electrical installation usually met in individual house or apartment. Demonstration board is to be used preferably by sales personnel when demonstrating operation of electrical installation test equipment. Various test methods supported by different test instruments can be presented. MI 2166 is compatible with all Metrel's Installation Safety Testers.



### KEY FEATURES

- A number of different measurements in accordance to EN 61557 are possible (insulation resistance, continuity of PE conductors, earth resistance (four-lead and two clamp methods), specific earth resistance, line and loop impedance, phase rotation, load current, RCD testing, contact voltage, etc.).
- Real elements of electrical installation are placed on the front panel like RCD, ON/OFF switch with lamp, mains test outlet and connection terminals.
- All standardised testing methods can be presented.
- 5 different errors can be pre-set by »fault« switches.
- TN or TT system can be simulated.
- Demonstration board is put in the strong rugged case with a handle for comfortable carrying.

### APPLICATION

- Presentation of complete testing of any electrical installation;
- Demonstration of electrical installation test equipment operation by sales personnel.

### STANDARDS

#### Electromagnetic compatibility

- IEC/EN 61326

#### Safety

- IEC/EN 61010 -1;

### STANDARD SET

#### MI 2166

- Demonstration board
- Jumper, 2 pcs
- Mains cable
- Instruction manual
- Calibration certificate

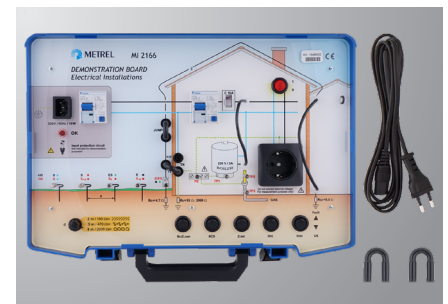

Picture of MI 2166 set

### TECHNICAL DATA

Power supply	230 V, 50 Hz
Dimensions	450 × 330 × 110 mm
Weight	3.56 kg

# Demonstration boards

## MI 3300 Portable Appliance Simulation Board



The MI 3300 GT Demoboard is an excellent instrument for teaching or demonstrating GT testing. The MI 3300 simulates a wide variety of portable equipment in normal operation or in fault conditions with the simple flick of a switch. The strong rugged portable case with detachable lid allows the unit to be easily moved between sites. The ability of the unit to simulate unlimited number of different equipment and the possibility to set fault conditions make the GT Demoboard the ideal unit for teaching or assessing learning in classrooms, training sessions, demonstration sessions, seminars and on GT training courses.

### KEY FEATURES

- Practically unlimited number of different equipment (portable appliances, machines and switchgears) can be simulated by using different tables (eight are included in a standard set).
- On demand the demonstration board can be simply upgraded with new tables.
- Normal and fault situations can be switched on and off, offering fault conditions for the assessment of learning.
- Demoboard simulates the following faults: PE continuity faults, insulation

resistance faults, leakage and touch leakage faults, polarity and functional faults.

- The demonstration board is built into a strong rugged case with a handle and detachable lid for storing leads, adapters and manuals.

### APPLICATION

- Presentation of complete safety testing of any portable appliance, machine or switchgear;
- Demonstration of PAT test equipment operation by sales personnel.

### STANDARDS

#### Safety

- EN 61010-1

#### STANDARD SET

#### MI 3300

- Instrument GT Demoboard
- 8 demonstration tables (iron, receiver, IEC cord, extension drum, coffee machine, washing machine, switchgear)
- Jumper
- IEC cord
- Mains cable
- Class I mains cable
- Class II mains cable
- Test cable for discharge time testing
- Carrying bag for demonstration tables
- Handbook "Electrical Equipment Testing" on storage media
- Instruction manual
- Calibration certificate

### TECHNICAL DATA

Protection class	I
Nominal input voltage	230 V
Optional on request	115 V
Power consumption	15 VA max.
Overvoltage category	CAT II / 300 V
Frequency range	45 Hz ... 66 Hz
Pollution degree	2
Dimensions	345 x 160 x 335 mm
Weight	2.76 kg



Picture of MI 3300 set

# Demonstration boards MI 3299 HV demo BOX

The MI 3299 High voltage Demonstration Box 10 kV has been developed for demonstration purposes at high voltage insulation diagnostics. It simulates typical electrical insulation usually met in the industrial environment. It is equipped with high quality resistors in different ranges, high voltage capacitors and a discharge facility to simulate a breakdown phenomenon in gases. Additionally measurements of polarization index (PI), dielectric discharge (DD) and dielectric absorption ratio (DAR) can be demonstrated. Packed with all these features the demonstration box is also well suited for basic calibration of DC high voltage insulation resistance measuring instruments.



## KEY FEATURES

- 10 kV rated resistors with very low voltage coefficient.
- Resistive decade with 200 k $\Omega$ , 500 M $\Omega$ , 200 G $\Omega$  and 2 T $\Omega$  resistors.
- HV capacitors in 2.5  $\mu$ F and 5 nF range.
- Built-in spark gap and gas discharge tube.
- Demonstration of insulation breakdown in gases is possible.
- Two models of insulation material (good and bad cables) enable the demonstration of real insulation behaviour under high DC voltage.
- Demonstration box is put in the strong rugged case with handle for comfortable carrying.

## APPLICATION

- Demonstration of insulation diagnostics measurement with DC test voltage;
- Demonstration of functionality of HV insulation measuring instruments;
- Training centres, schools, laboratories;
- Basic calibration of DC high voltage insulation testers.

## STANDARDS

### Safety

- EN 61010 -1

## STANDARD SET

### MI 3299

- HV demo BOX 10 kV
- HV test leads, 2 pcs
- Instruction manual
- Handbook on storage media
- Calibration certificate

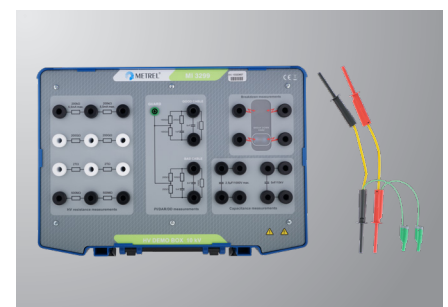

Picture of MI 3299 set

## TECHNICAL DATA

Dimensions	440 × 320 × 110 mm
Weight	4 kg

# Demonstration Boards

## MI 2891 Power Simulator



The MI 2891 Power Simulator is a multi-purpose three phase power simulator for simulating typical situations in low voltage power supply systems. It is an excellent tool for training, demonstration purposes, or as an electrical didactic tool. The simulator has some pre-programmed scenarios, and also the option of a complete manual mode. The user can decide between different load character adjustments, adjustable current and voltage level with a simulation of various different faulty conditions

### SIMULATING FUNCTIONS

- Voltage;
- Current;
- Frequency;
- Harmonics (U,I);
- Phase angle (U,I);
- Flicker;
- Load character;
- Network type (Load/Generator);
- Unbalance (U,I);
- Phase sequence (U,I).

### KEY FEATURES

- Simple and powerful waveform generator with various settings.
- 4 voltage channels with wide simulation range: up to 350 Vrms.
- 4 current channels with current clamps simulation up to 2 kA.
- Simultaneous voltage and current (8 channels) simulation, 16 bit DA conversion for accurate signal generation.
- Dip, swell, interrupt, signalling, transient and inrush events simulation.
- Voltage and current harmonics waveform simulation.
- Unbalanced voltage and current waveform simulation.
- Square flicker simulation.
- Various character load/character type combination simulation.
- Thorough signal parameters settings.
- Saving current system settings on power off.
- 4.3" TFT colour display.

### APPLICATION

- Training purposes;
- Demonstration of PQA testing equipment by sales personnel;
- Education of students of electro technical specialities.

### STANDARDS

**Safety:**

- EN 61010-1: 2010

**Electromagnetic compatibility (EMC):**

- EN 61326-2-2: 2013



## TECHNICAL DATA

<b>Fundamental RMS voltage output</b>			
Output voltage AC 50 ... 300 V	Resolution 10V	Accuracy ± 0.1 %	
<b>Event RMS voltage output</b>			
Output voltage AC 0 ... 350 V	Resolution 10V	Accuracy ± 0.1 %	
<b>Fundamental RMS current</b>			
Range A 1033 (100 A ... 2000 A)	Output voltage 100 mV ... 1 V	Overall current accuracy ±0.1 %	
<b>Inrush RMS current output</b>			
Inrush current Range 1: 2.0 mVRMS ... 200.0 mVRMS Range 2: 20.0 mVRMS ... 2.0000 VRMS	Accuracy ± 0.5 % · URMS ± 0.5 % · URMS	Crest factor 1.5 1.5	
<b>Frequency</b>			
Output range 45 Hz ... 70 Hz	Resolution 1 Hz	Accuracy ± 10 mHz	
<b>Flickers</b>			
Flicker type Pst	Measuring range 0.5 ... 5.0	Resolution 0.1	Accuracy* ± 1 %
<b>Voltage harmonics</b>			
Measuring range UhN 1 % ... 100 % of fundamental output voltage UhN: N:	Resolution 1% generated harmonic voltage harmonic component 2nd ... 50th	Accuracy ± 5 % of UhN	
<b>Current harmonics and THD</b>			
Measuring range IhN 1 % ... 100 % of fundamental current IhN: N:	Resolution 1% measured harmonic current harmonic component 2th ... 50th	Accuracy ± 5 % of IhN	
<b>Unbalance</b>			
u-  u0 i-  i0	Unbalance range 0.5 % ... 5.0 %  0.0 % ... 20 %	Resolution 0.1 %  0.1 %	Accuracy ± 0.15 %  ± 1 %
<b>Overdeviation and Underdeviation</b>			
UOver UUnder	Measuring range 0 ... 50 % UNom 0 ... 90 % UNom	Resolution 0.001 % 0.001 %	Accuracy ± 0.15 % ± 0.15 %
<b>Event duration and recorder time-stamp and uncertainty</b>			
Event Duration Record and Event Time stamp	Measuring Range 10 ms ... 7 days N/A	Resolution 1 ms 1 ms	Error ± 1 cycle ± 1 cycle
<b>General</b>			
Measuring category Dimensions Weight (with batteries) Display Batteries Working temperature range	CAT I / 300 V 230 x 140 x 80 mm 1,34 kg Colour 4.3 TFT liquid crystal display (LCD) with backlight, 480 x 272 dots. 6 x 1.2 V NiMH rechargeable batteries type HR 6 (AA) -20 °C ... +40 °C		

### STANDARD SET

#### MI 2891

- Instrument Power Simulator
- Voltage measurement lead, (brown, black, grey, green, blue), 5 pcs
- Current measurement leads, 4pcs

- Labels for color coding
- Power supply adapter
- 1.2 V NiMH rechargeable battery, 6 pcs
- Soft carrying bag
- USB cable
- Instruction manual



Picture of MI 2891 set



# Content

## Multimeters / Clamp meters / Voltage testers / Thermal cameras

Electrical Installation Safety	1.1 - 1.72
High Voltage Insulation / Continuity / Earth / Transformer	2.1 - 2.48
Appliance / Machine / Switchboard Safety	3.1 - 3.52
Power Quality Analysis	4.1 - 4.26
Equipment for laboratories and Schools	5.1 - 5.16
<b>MULTIMETERS / CLAMP METERS / VOLTAGE TESTERS / THERMAL CAMERAS</b>	<b>6.1 - 6.44</b>
Software	7.1 - 7.19

### GOOD TO KNOW

Multimeters / Clamp meters / Voltage testers / Thermal cameras	6.02
--	------

### DIGITAL MULTIMETERS

Selection Guide for Digital Multimeters	6.04
MD 9070 Insulation/continuity Digital Multimeter	6.06
MD 9060 TRMS, 100 kHz Voltage Bandwidth Heavy Duty Industrial Multimeter	6.08
MD 9055 TRMS Advanced Multimeter <b>NEW</b>	6.10
MD 9050 TRMS Heavy Duty Industrial Digital Multimeter	6.12
MD 9040 TRMS Industrial Digital Multimeter	6.13
MD 9030 TRMS General Purpose Digital Multimeter	6.14
MD 9020 General Purpose Digital Multimeter	6.15
MD 9016 Electrical Field Service Multimeter	6.16
MD 9010 General Purpose Autocheck Digital Multimeter	6.17

### CLAMP METERS

Selection Guide for Clamp Meters	6.18
MD 9273 Bluetooth® TRMS Leakage Clamp with Power Functions <b>NEW</b>	6.20
MD 9272 Leakage Clamp TRMS Meter with Power Functions	6.21
MD 9260 TRMS Photovoltaic Clamp Meter CAT III 1500 VDC <b>NEW</b>	6.22
MD 9250 Industrial TRMS AC/DC CAT IV /1000 V	6.23
MD 9240 TRMS Power Clamp Meter	6.24
MD 9235 TRMS Power Clamp Meter, 3-Phase, Unbalanced-Load	6.25
MD 9231 Industrial TRMS AC/DC Current Clamp Meter	6.26
MD 9226 TRMS AC/DC Current Clamp Meter	6.27
MD 9210 Mini Clamp Meter	6.28

### VOLTAGE AND CONTINUITY TESTERS

Selection Guide for Voltage and Continuity Testers	6.30
MD 1160 LED Voltage / Continuity Tester	6.31
MD 1060 LCD Voltage / Continuity Tester	6.32

### NON CONTACT VOLTAGE DETECTORS

Selection Guide for Non Contact Voltage Detector	6.33
MD 126 Non-contact voltage and phase rotation detector	6.35
MD 116 Non Contact Voltage Detector	6.36
MD 106 Non Contact Voltage Detector	6.37

### THERMAL CAMERAS

Selection Guide for Thermal cameras	6.38
MD 9930 Thermal camera	6.39
MD 9910 Thermal camera	6.40
MD 9880 TRMS thermal multimeter	6.41

### SELECTION GUIDE FOR DMM ACCESSORIES

6.43
------

# Good to know

## Multimeters / Clamp meters / Voltage testers / Thermal cameras

### Find out more about DMMs, clamp meters and thermal cameras.

Handheld digital multimeters (DMM) are among the most widely used instruments for equipment testing when it comes to servicing, repairing, and installing applications.

A DMM is a digital meter that is capable of making various types of measurement. It may have any number of special features, but mainly a DMM measures volts, ohms, and amperes. DMMs are used to troubleshoot electrical problems in a wide array of industrial and household devices such as batteries, motor controls, appliances, power supplies, and wiring systems.

Metrel DMMs are appropriate for testing under tough conditions and can be tossed into tool cases.

When choosing a clamp meter not only look at specifications, but also pay attention to features, functions, and the overall value represented by a meter's design:

- Choose a clamp meter that gives accurate and repeatable results.
- For precise measurements choose a clamp meter which reports TRMS reading. Otherwise noise from everything from a variable frequency drive to compact fluorescent bulbs can result in a less accurate reading.
- Make sure that the clamp meter is specified to work in the environment you do and that are rugged enough to continue to give reliable results even in case they drop from ladders or bouncing in your tool case.
- Be sure the clamp meter display has large, easy to read characters.

### RMS (Root Mean Square) value

When an AC supply is placed onto a circuit, it produces heat. The RMS value is the equivalent DC supply that would produce the same amount of thermal heat as the actual AC supply.

### TRMS (True RMS) value

TRMS is a specific method of measuring the RMS value of a signal. With inductive and capacitive systems distorting the sinusoidal wave of the mains supply, this method provides the most accurate RMS value regardless of the shape of the waveform.

### Resolution

Resolution is the smallest possible change in a signal that would produce a change in the value on the screen of the test instrument. For example, if the DMM has a resolution of 1 mV on the 4 V range, it is possible to see a change of 1 mV (1/1000 of a volt) while reading 1 V.

### Accuracy

Accuracy is a value to show how accurately an instrument can read a specific value. This is usually written as a percentage (e.g.  $5\text{ V} \pm 5\%$ ). An accuracy of one percent of reading means that for a displayed reading of 100 volts, the actual value of the voltage could be anywhere between 99 volts and 101 volts.

### Number of Counts

The number of divisions into which a given measuring range is divided. This can be used to evaluate the resolution of an instrument.

### The basics of measurements

#### DC and AC voltage

One of the most basic tasks of a DMM is measuring voltage. A typical DC voltage source are the batteries while AC voltage is usually created by a generator. The wall outlets are common sources of AC voltage.

Testing for proper supply voltage is usually the first step when troubleshooting a circuit. If there is no voltage present, or if it is too high or too low, the voltage problem should be corrected before investigating further. A DMM's ability to measure AC voltage can be limited by the frequency of the signal. Most DMMs can accurately measure AC voltages with frequencies from 50 Hz to 500 Hz, but a DMMs AC measurement bandwidth may be hundreds of kilohertz wide. Such a meter may read a higher value because it is capable to see more of a complex ac signal. DMM accuracy specifications for AC voltage and AC current should state the frequency range along with the range's accuracy.

Frequency is measured in hertz (Hz) the number of times per second a waveform repeats. Maintaining the right frequency is crucial for devices that rely on AC voltage and current.

### Crest factor

The crest factor describes the ratio of the peak value to the RMS value of an electrical variable (AC voltage and AC current). High crest factors cause distortion of the reactive power and harmonics in the supply network, and so are undesirable.

### Resistance

Resistance values can vary greatly, from a few milliohms ( $\text{m}\Omega$ ) for contact resistance to billions of ohms for insulators. Most DMMs measure from  $0.1\ \Omega$ , up to  $300\ \text{M}\Omega$ . At Metrel DMM display is infinite resistance (open circuit) read as "OL" and means that the resistance is greater than the meter can measure. Resistance measurements must be made with the circuit power off – otherwise, the meter or circuit could be damaged.

### Continuity

Continuity is a quick "go/no-go" resistance test that distinguishes between an open and a closed circuit. A DMM with a continuity beeper allows you to complete many continuity tests easily and quickly. The DMM will beep if there is good continuity, or a good path that allows current to flow. If there is no continuity, the DMM won't beep.

### Diode test

This mode measures and displays the actual voltage drop across a junction. A silicon junction should have a voltage drop less than 0.7 V when applied in the forward direction and an open circuit when applied in the reverse direction. When the red (+) lead is connected to the anode and the black (-) to the cathode, the diode should conduct and the meter will display a value (usually the voltage across the diode in mV,  $1000\text{mV} = 1\text{V}$ ). After reversing the connections the diode should not conduct this way so the meter will display "OL".

### Capacitance

To test capacitance, set the dial on the DMM to the capacitance function and plug in your leads. After ensuring that the capacitor has been discharged, connect the test leads to the capacitor terminals and take a reading. If the measurement is similar to the rating listed on the capacitor, the capacitor is good. A significant variation from the rating indicates the capacitor should be replaced.

### DC and AC current

Current measurements are different from other DMM measurements. Current measurements taken with the DMM alone require placing the meter in series with the circuit being measured. This means opening the circuit and using the DMM test leads to complete the circuit. This way all the circuit current flows through the DMMs circuitry.

### Current with Clamp Meter

Today's clamp meters are capable of measuring both AC and DC current. Typical current measurements are taken on various branch circuits of an electrical distribution system. By taking current measurements along the run of a branch circuit, it can be easily determined how much each load along the branch circuit is drawing from the distribution system. Many problems in buildings are invisible to the eye at first and only show up when damage is bad in irreversible, like leaks in buildings or bearing damage in engines. Cameras visualise the cool and hot spots that indicate such problems. They translate the temperature of the scene to a range of false colours.

### Temperature

The most obvious measuring capability of a thermal camera is temperature measurement. Apart from the sensors that form the image, cameras possess a laser thermometer that usually indicates the temperature in the central point of the image. It also uses the thermometer to self-calibrate, adjusting the image so that the hottest point in it corresponds to one edge of the false colour spectrum and the coldest to the lowest. This makes for greatest temperature resolution in a single scene. To compare virtually similar scenes or the same scene at different times, the range must be locked.

### Reflected temperature

The camera measures the amount of radiation coming off the measured item. This amount can be a combination of different sources. The most obvious source of heat apart from the item is usually the ambient temperature. The camera can measure it when pointed into a distance, away from anything it could focus on. The measured ambient temperature can be set as a global parameter to correct the image and the measurements.

### Reflective index

Another factor that influences amount of radiation emitting from an item is its emissivity or reflectivity. It can mostly radiate from inside, or it can mostly reflect heat from other sources. Emissivity as a factor for a material can be found in tables. MD 9930 has them built in to make accurate measurements easier. One has to keep in mind that once set, the emissivity will hold for the whole image, not just the item of interest.



### Camera features







Optical and other features of a thermal camera are the same as for a visible light one. Resolution of the sensor speaks about a number of points where temperature was measured. Focal length is a measure of magnification of the scene and of angle of view. Shorter lengths mean lower magnification and wider angle of view. Spatial resolution is the real dimension that is represented by a pixel on an image. It is expressed as a spatial angle, as it depends on distance from the lens. The smaller the angle, the higher the resolution. Minimum focus distance is the minimum distance the camera can focus the lens to. Cheaper models have fixed focus, which means all the items further than that are focused. Manual focus means different distances can be focused by hand. Combined with zoom, it can bring details from the distance.



# Digital multimeters

## Selection Guide for Multimeters

FEATURES	Description	MD 9070 Digital multimeter	MD 9060 Digital multimeter	MD 9055 Digital multimeter <b>NEW</b>
				
<b>MEASUREMENTS</b>	True RMS	•	•	•
	Count	6000	50,000 (fast mode), 500,000 (stable DCV), 99,999 (Hz)	60000
	Update rate (/s)	5	fast mode 5, stable mode 1.25	5
	DC voltage ranges (V)	6 V ... 1000 V	500 mV ... 1000 V	600 mV ... 1000 V
	Best accuracy (%)	0,2	0,02	0,03
	Maximum resolution (µV)	1000	10	10
	AC voltage ranges (V)	6 V ... 1000 V	500 mV ... 1000 V	600 mV ... 1000 V
	Best accuracy (%)	1	0,3	0,5
	Maximum resolution (µV)	1000	10	10
	DC current ranges (A)		500 µA ... 10 A	600 µA ... 10 A
	Best accuracy (%)		0,15	0,075
	Maximum resolution (µA)		0,1	0,01
	AC current ranges (A)		500 µA ... 10 A	600 µA ... 10 A
	Best accuracy (%)		0,5	0,9
	Maximum resolution (µA)		0,1	0,01
	Resistance measurement ranges	600 Ω ... 60 MΩ	500 Ω ... 50 MΩ	600 Ω ... 60 MΩ
	Best accuracy (%)	0,9	0,07	0,085
	Maximum resolution (mΩ)	100	100	10
	Acoustic continuity test	•	•	•
	Diode test	•	•	•
	Capacitance ranges		50 nF ... 25 mF	10 nF ... 10 mF
	Best accuracy (%)		0,8	1,0
	Frequency measurement	10 Hz ... 20 kHz	10 Hz ... 200 kHz	10 Hz ~ 50 kHz
	Best accuracy (%)	0.02	0.02	0.05
	Temperature measurement (Type K sensor)		-50.0°C ... 1000.0°C with comparison	-200.0°C ~ 1090.0°C with comparison
	Best accuracy (%)		0.3	1
<b>SPECIAL FEATURES</b>	Earth continuity test	•		
	Insulation resistance	•		
	Compare to threshold	•		
	PI / DAR	•		
	Conductance (nS)		•	•
	Duty cycle (%)		•	•
	Logic frequency		•	•
	dBm measurement		•	•
	100 kHz Voltage Bandwidth		•	
	Variable frequency drive	•	•	•
	Non-contact electrical field detection (EF)			•
	4-20 mA DC current loop (%)		•	•
	Analogue bar-graph	61 segment	41 segment	30 segment
	Bar-graph update rate (/s)	40	60	50
	Automatic and manual range selection	•	•	•
	Compensation for test leads			
	Incorrect lead connection alert	•	•	•
	Autocheck® with Lo-Z			•
	Hold fast data/crest capture		5 ms	0.25 ms
	Data hold	•	•	•
	Recording (MAX / MIN / AVG)	MAX / MIN	MAX / MIN / AVG	MAX / MIN / AVG
	Relative value		•	•
	Dual data display	•	•	•
	Backlight	•	•	•
	Flashlight			
	Optical interface		•	•
	Automatic switch off	•	•	•
<b>GENERAL</b>	Overvoltage category	CAT IV / 600 V CAT III / 1000 V	CAT IV / 1000 V	CAT IV / 600 V CAT III / 1000 V
	Dimensions with holster (mm)	208 x 103 x 64,5	208 x 103 x 64,5	193 x 89 x 51
	Weight with holster (g)	635	635	420
	IP	IP 40	IP 54	IP 40
	CE mark	•	•	•

MD 9050 Digital multimeter	MD 9040 Digital multimeter	MD 9016 Digital multimeter	MD 9030 Digital multimeter	MD 9020 Digital multimeter	MD 9010 Digital multimeter
					
•	•	•	•	•	•
9999 (AC/DCV, Hz, nS), 6000 (mV, $\mu$ m/A, W, F)	9999 (AC/DCV, Hz, nS), 6000 (mV, $\mu$ m/A, W, F)	6000	4000	4000	6000
5	5	3	3	3	5
60 mV ... 1000 V	60 mV ... 1000 V	60 mV ... 1000 V	400mV ... 1000 V	400mV ... 1000 V	6 V ... 600 V
0,06	0,06	0,2	0,3	0,3	0,5
10	10	10	100	100	1000
60 mV ... 1000 V	60 mV ... 1000 V	60 mV ... 1000 V	400mV ... 1000 V	400mV ... 1000 V	6 V ... 600 V
0,5	0,5	1	1,5	1,5	1,5
10	10	10	100	100	1000
600 $\mu$ A ... 10 A	600 $\mu$ A ... 10 A	600 $\mu$ A ... 10 A	400 $\mu$ A ... 10 A	400 $\mu$ A ... 10 A	400 $\mu$ A, 2000 $\mu$ A
0,2	0,2	0,5	1,2	1,2	1,2
0,1	0,1	0,1	0,1	0,1	0,1
600 $\mu$ A ... 10 A	600 $\mu$ A ... 10 A	600 $\mu$ A ... 10 A	400 $\mu$ A ... 10 A	400 $\mu$ A ... 10 A	400 $\mu$ A, 2000 $\mu$ A
0,6	0,6	1	1,5	1,5	1,5
0,1	0,1	0,1	0,1	0,1	0,1
600 $\Omega$ ... 60 M $\Omega$	600 $\Omega$ ... 60 M $\Omega$	600 $\Omega$ ... 60 M $\Omega$	400 $\Omega$ ... 40 M $\Omega$	400 $\Omega$ ... 40 M $\Omega$	600 $\Omega$ ... 6 M $\Omega$
0,1	0,1	0,5	0,6	0,6	1
100	100	100	100	100	100
•	•	•	•	•	•
•	•	•	•	•	•
60 nF ... 25 mF	60 nF ... 25 mF	60 nF ... 3000 $\mu$ F	500 nF ... 3000 $\mu$ F	500 nF ... 3000 $\mu$ F	100 nF ... 2000 $\mu$ F
0,8	0,8	1,5	3,5	3,5	3,5
15 Hz ... 50 kHz	15 Hz ... 50 kHz	10 Hz ... 50 kHz	50 Hz ... 1 MHz	50 Hz ... 1 MHz	10 Hz ... 1 kHz
0,04	0,04	0,03	0,5	0,5	0,5
-50,0°C ... 1000,0°C with comparison		-50,0°C ... 1000,0°C	-20,0°C ... 300,0°C	-20,0°C ... 300,0°C	
0,3	0,3	0,3	2	2	
•	•	•	•	•	•
•	•	•	•	•	•
•	•	•	•	•	•
•	•	•	•	•	•
41 segment	41 segment	24 segment			
60	61	40			
•	•	•	•	•	Auto
•	•	•	•	•	
•	•	•	•	•	
•	•	•	•	•	
ACV/DCV/ $\Omega$					ACV/DCV/ $\Omega$
1ms					
•	•	•	•	•	
MAX / MIN / AVG		MAX	MAX	MAX	
•	•	•	•	•	
•	•	•	•	•	
•	•	•	•	•	
•	•	•	•	•	
CAT IV / 1000 V	CAT IV / 1000 V	CAT IV / 300 V CAT III / 600 V CAT II / 1000 V	CAT IV / 300 V CAT III / 600 V CAT II / 1000 V	CAT IV / 300 V CAT III / 600 V CAT II / 1000 V	CAT III / 300 V CAT II / 600 V
208 x 103 x 64,5	208 x 103 x 64,5	161 x 80 x 50	198 x 97 x 55	198 x 97 x 55	113 x 53 x 10,2
635	635	340	396	396	78
IP 54	IP 54	IP 40	IP 40	IP 40	IP 40
•	•	•	•	•	•

# Digital multimeter

## MD 9070 TRMS Insulation / Continuity Digital Multimeter



The MD 9070 is a high accuracy insulation and continuity multimeter which may be used in a CAT IV / 600 V environment. It's dual digital display provides all needed data to the operator while it's size ensures that it can be operated single handedly. The instrument is equipped with a built-in VFD feature that makes the instrument capable of measuring true RMS values in accordance with frequency, performing PI/DAR measurements and diode test. The MD 9070 has a wide range of extra features, including data hold, memory, min / max, differential, auto power off, auto-ranging, frequency filter, lock feature, reset, relative function and more.

### MEASURING FUNCTIONS

- TRMS measurement;
- Insulation resistance measurement;
- Earth continuity measurement;
- Resistance measurement;
- Diode test;
- Mains supply frequency measurement;
- Frequency of digital signals measurement.

### KEY FEATURES

- **TRMS:** accurate readings on sinusoidal and non-sinusoidal signals.
- **VFD:** feature makes the instrument capable of measuring the true values in accordance with frequency.
- **Auto-ranging:** user can switch between auto and manual ranging.

- **Relative zero mode:** relative function for comparing the difference between signals or removing background noise.
- **MAX/MIN:** recording of maximum, minimum and average values.
- **Data Hold:** data hold feature freezes the display for later view.
- **PI/DAR:** feature.
- **Safety:** CAT IV / 600 V and CAT III / 1000 V overvoltage protection.
- **Backlight:** working in dark conditions.

### APPLICATION

- Insulation and earth continuity tester for preventive maintenance;
- High level industrial testing;
- High level electronic fault finding;
- Field servicing;
- Heavy duty electrical testing.

### STANDARDS

- CAN/CSA-C22.2 No. 61010-1-12 Ed. 3.0
- EN61326-1:2006
- EN55022
- EN61000-3-2
- EN61000-3-3
- EN61000-4-2
- EN61000-4-3
- EN61000-4-4
- EN61000-4-5
- EN61000-4-6
- EN61000-4-8
- EN61000-4-11
- IEC/UL/EN61010-1 Ed. 3.0
- IEC/EN61010-2-030 Ed. 1.0
- IEC/EN61010-2-033 Ed. 1.0
- IEC/UL/EN61010-031 Ed. 1.1
- IEC/EN61557-1
- IEC/EN61557-2

### Directives

- 2004/108/EC EMC
- 2006/95/EC LVD



## TECHNICAL DATA

FUNCTION	Range	Accuracy
TRMS AC Voltage (50 Hz ... 5 kHz)	6.000 V ... 1000 V	From $\pm(1.0\%$ of reading + 3 digits) to $\pm(4.0\%$ of reading + 5 digits)
VFD AC Voltage (10 Hz ... 440 Hz)	600.0 V	From $\pm(4.0\%$ of reading + 5 digits) to $\pm(7.0\%$ of reading + 5 digits)
DC Voltage	6.000 V ... 1000 V	From $\pm(0.2\%$ of reading + 3 digits) to $\pm(0.3\%$ of reading + 3 digits)
DC Current	60 mA ... 600 mA	From $\pm(0,5\%$ of reading + 3 digits)
AC Current (50 Hz ... 1 kHz)	60 mA ... 600 mA	to $\pm(1,5\%$ of reading + 3 digits)
Ohms	600.0 $\Omega$ ... 60.00 M $\Omega$	From $\pm(0.9\%$ of reading + 2 digits) to $\pm(3.0\%$ of reading + 6 digits)
Audible Continuity Tester	between 20 $\Omega$ and 200 $\Omega$	Response time < 30 ms
Diode Tester	2.000 V	$\pm(1.5\%$ of reading + 4 digits)
Earth Continuity Test	0.015 $\Omega$ ... 2.199 $\Omega$ at $I_{test} > 200$ mA 0.15 $\Omega$ ... 21.99 $\Omega$ at $I_{test} > 90$ mA	$\pm(1.5\%$ of reading + 3 digits) $\pm(1.5\%$ of reading + 3 digits)
Hz Line Level Frequency	10 Hz ... 440 Hz; range VFD 600 V 10 Hz ... 20 kHz; range 6 V ... 1000 V	$\pm(0.02\%$ of reading + 4 digits) $\pm(0.02\%$ of reading + 4 digits)
Insulation Resistance	3.000 M $\Omega$ ... 55.0 M $\Omega$ at 50 V 3.000 M $\Omega$ ... 110.0 M $\Omega$ at 100 V 3.000 M $\Omega$ ... 275.0 M $\Omega$ at 250 V 3.000 M $\Omega$ ... 550.0 M $\Omega$ at 500 V 3.000 M $\Omega$ ... 300.0 M $\Omega$ at 1000 V 3000 M $\Omega$ at 1000 V 25.0 G $\Omega$ at 1000 V	$\pm(1.5\%$ of reading + 5 digits) $\pm(1.5\%$ of reading + 5 digits) $\pm(1.5\%$ of reading + 5 digits) $\pm(1.5\%$ of reading + 5 digits) $\pm(1.5\%$ of reading + 5 digits) $\pm(2.0\%$ of reading + 5 digits) $\pm(10.0\%$ of reading + 5 digits)
Sensing	AC, True RMS.	
Overload Protections	Insulation Resistance: 0.4 A / 1 KV, IR 30 kA or better Earth Continuity Test: 0,25 A /1 KV, IR 30 kA or better. V: 1100 Vrms. mV, $\Omega$ & Others: 1000 Vrms.	
Power Supply	Four Alkaline AA batteries (IEC LR6).	
Power Consumption	4.5mA typical	
Dimension (L x W x H)	208 x 103 x 64,5 mm with holster.	
Weight	635 g with holster.	

### STANDARD SET

#### MD 9070

- Multimeter MD 9070 with rubber holster
- Test lead with probe, 2 pcs
- Insulated crocodile clip, 2 pcs

- Insulation/Continuity test lead with probe, 1 pcs
- 1,5 V AA battery (IEC LR6), 4 pcs
- Instruction manual
- Warranty



Picture of MD 9070 set

# Digital multimeters

## MD 9060 TRMS, 100 kHz Voltage Bandwidth Heavy Duty Industrial Multimeter



The MD 9060 ranks among the most accurate multimeters with a large bandwidth and very high resolution. Metrel MD 9060 is equipped with a built-in VFD feature that makes the instrument capable of measuring the true values in accordance with frequency, large 2-line 500.000 counts LCD display, fast data acquisition and transfer (via optical interface), CAT IV / 1000 V, TRMS current and voltage measurement, conductance measurement and fast one-handed operation. MD 9060 has a wide range of extra features, including data hold, memory, min / max, average, differential, peak, peak / peak with extra fast 1ms response time, auto power off, frequency filter, reset and relative function. The MD 9060 is the ideal choice for demanding measurement tasks in industry, in the laboratories and in everyday repair and maintenance practice.

### MEASURING FUNCTIONS

- TRMS AC, DC voltage measurement;
- TRMS AC, DC current measurement;
- Capacitance measurement;
- Resistance measurement;
- Diode test;
- Duty Cycle;
- Mains supply frequency measurement;
- Frequency of digital signals measurement;
- Continuity test (acoustic signalling);
- Conductance measurement;
- Temperature measurement.

### KEY FEATURES

- **TRMS:** accurate readings on sinusoidal and non-sinusoidal signals.
- **VFD:** feature makes the instrument capable of measuring the true values in accordance with frequency.
- **Duty cycle:** measure digital logic level duty cycle.
- **Auto-ranging:** user can switch between auto and manual ranging.
- **Temperature measurement:** measures T1, T2 and T1 + T2 temperature in Celsius and in Fahrenheit.
- **Lead alert:** incorrect lead connection alert.
- **Relative zero mode:** relative function for comparing the difference between signals or removing background noise.
- **MAX/MIN/AVG:** recording of maximum, minimum and average values.
- **Data Hold:** data hold feature freezes the display for later view.
- **Peak Hold:** Crest (instantaneous peak) capture mode.
- **PC Link:** test results can be downloaded to the computer via the optional PC software.
- **Safety:** CAT IV / 1000 V overvoltage protection.
- **Backlight:** large bright 500.000 counts dual LCD display with backlight for working in dark conditions.

### APPLICATION

- High level industrial testing;
- High level electronic fault finding;
- Field servicing;
- Heavy duty electrical testing.

## TECHNICAL DATA

FUNCTION	Range	Accuracy
TRMS AC and AC+DC voltage (20 Hz ... 40kHz)	500.00 mV ... 1000.0 V	from $\pm(0.45\%$ of reading + 40 digits) to $\pm(4.0\%$ of reading + 40 digits)
DC Voltage	500.00 mV ... 1000.0 V	from $\pm(0.02\%$ of reading + 2 digits) to $\pm(0.15\%$ of reading + 2 digits)
AC Voltage (20 Hz ... 100 kHz)	500.00 mV ... 1000.0 V	from $\pm(0.3\%$ of reading + 20 digits) to $\pm(4.0\%$ of reading + 40 digits)
DC Current	500.00 $\mu$ A ... 10.000 A	from $\pm(0.15\%$ of reading + 20 digits) to $\pm(0.5\%$ of reading + 20 digits)
TRMS AC and AC+DC Current (40 Hz ... 100 kHz)	600.0 $\mu$ A ... 10.00 A	from $\pm(0.5\%$ of reading + 50 digits) to $\pm(5.0\%$ of reading + 50 digits)
Diode Test	2.0000 V Open-circuit voltage < 3.5 V DC, Test current 0.4 mA	$\pm(1.0\%$ of reading + 1 digit)
Resistance	500.00 $\Omega$ ... 50.000 M $\Omega$	from $\pm(0.07\%$ of reading + 10 digits) to $\pm(2.0\%$ of reading + 6 digits)
Conductance	99.99 nS	$\pm(2.0\%$ of reading + 10 digits)
Capacitance	50.00 nF ... 25.00 mF	from $\pm(0.8\%$ of reading + 3 digits) to $\pm(6.5\%$ of reading + 5 digits)
Temperature	-50.0 $^{\circ}$ C ... 1000.0 $^{\circ}$ C -58.0 $^{\circ}$ F ... 1832.0 $^{\circ}$ F	$\pm(0.3\%$ of reading + 1.5 $^{\circ}$ C) $\pm(0.3\%$ of reading + 3.0 $^{\circ}$ F)
Variable Frequency Drive AC	5 Hz ... 440 Hz	from $\pm(2.0\%$ of reading + 50 digits) to $\pm(6.0\%$ of reading + 80 digits)
Frequency of digital equipment	5.000 Hz ... 1.0000 MHz	$\pm(0.002\%$ of reading + 4 digits)
Mains frequency	10 Hz ... 200 kHz	$\pm(0.02\%$ of reading + 4 digits)
Power supply	9V battery (NEDA1604G, JIS006P, or IEC6F22)	
Overvoltage category	CAT IV / 1000 V	
Dimensions	208 x 103 x 64.5 mm	
Weight	635 g	

### STANDARD SET

#### MD 9060

- Multimeter MD 9060 with rubber holster
- Test lead with probe, 2 pcs
- Thermocouple probe, type K

- 9 V battery,
- Instruction manual
- Warranty



Picture of MD 9060 set

# Digital multimeters

## MD 9055 TRMS Advanced Multimeter

NEW

Digital multimeters



The MD 9055 is another name for versatility in a small package. It supports a large number of measurements that make it a staple in both industrial and research environments. It has a 60000 counts display and supports a very wide array of measurements, including auto-hold of the measurement for working in confined spaces.

### MEASUREMENT FUNCTIONS

- TRMS AC, DC voltage measurement;
- TRMS AC, DC current measurement;
- Capacitance measurement;
- Resistance measurement;
- Diode test;
- Mains supply frequency measurement;
- Frequency measurement of digital signals;
- Continuity test (acoustic signalling);
- Conductance measurement;
- Temperature measurement;
- 4-20 mA regulation loop test;
- Non-contact electrical field detection.

### KEY FUNCTIONS

- **TRMS:** accurate readings on sinusoidal and non-sinusoidal signals.
- **Auto-ranging:** user can switch between auto and manual ranging.
- **Temperature measurement:** measures T1, T2 and T1 + T2 temperature in Celsius and in Fahrenheit.
- **Lead alert:** incorrect lead connection alert.
- **dBm measurement** results with settable reference value.
- **Auto-hold** to freeze the measurement result for comfortable viewing.
- **Relative zero mode:** relative function for comparing the difference between signals or removing background noise.
- **VFD:** feature makes the instrument capable of measuring the true values in accordance with frequency.
- **MAX/MIN/AVG:** recording of maximum, minimum and average values.
- **Crest** (instantaneous peak) capture mode catches 5 ms long peaks.
- **Safety:** CAT III / 1000 V and CAT IV / 600 V overvoltage protection.
- **Backlight:** large bright 4 digits 60.000 counts dual LCD display with backlight for working in dark conditions.

### APPLICATIONS

- High level industrial testing.
- High level electronic fault finding.
- Field servicing.
- Heavy duty electrical testing.

## TECHNICAL DATA

FUNCTION	Range	Accuracy
DC Voltage	0 ... 1000 V	0.03 % of reading + 2 digits
AC Voltage	0 ... 1000 V, 50 Hz ... 100 kHz	0.5 % of reading + 30 digits
AC+DC Voltage	0 ... 1000 V, 50 Hz ... 20 kHz	0.7 % of reading + 40 digits
VFD AC Voltage	0 ... 1000 V	4 % of reading + 50 digits
LoZ Auto-DCV	0 ... 1000 V	0.5 % of reading + 30 digits
LoZ Auto-ACV	0 ... 1000 V	1.0 % of reading + 40 digits
dBm	Subject to ACmV, ACV and reference impedance selected	
Ohms	600 Ω ... 60 MΩ	0.085 % of reading + 10 digits
BeepLit™ Continuity Tester	Threshold 100 Ω ... 420 Ω, response < 100 μs	
BeepLit™ Diode Tester	3.0000 V	1 % of reading + 20 digits
Capacitance	10 nF ... 10.00 mF	1.0 % of reading + 10 digits
DC Current	600 μA ... 10 A	0.075 % of reading + 20 digits
AC Current	600 μA ... 10 A	0.9 % of reading + 20 digits
AC+DC Current	600 μA ... 10 A	1.0 % of reading + 30 digits
DC Loop Current %4~20mA	4 mA = 0%; 20 mA = 100 %	±25 digits
Temperature	-200.0 °C ... 1090 °C	1.0 % of reading + 1.0 °C
Hz Logic Level Frequency	5.000 Hz ... 1.0000 MHz	0.002 % of reading + 4 digits
%Duty Cycle	0.10 % ... 99.99 %	3 d/kHz + 2 digits
~ Hz Line Level Frequency	10 Hz ... 50 kHz	0.05 % of reading + 5 digits
Non-Contact EF-Detection (NCV)	18 V ... 500 V	
MAX MIN AVG	Specified	Specified + 30 digits
CREST	Specified	Specified + 100 digits
AutoHold Real-Read™	Specified	Specified + 50 digits
Power supply	3 x 1.5 V batteries, type AAA	
Overvoltage category	CAT IV / 600 V, CAT III 1000 V	
Dimensions	193 x 89 x 51 mm	
Weight	420 g	

### STANDARD SET

#### MD 9055

- MD 9055 High performance TRMS multimeter
- AMD 9026 Test lead with probe, 2 pcs
- AMD 9023 Thermocouple probe type K

- 3 AA 1.5V batteries
- User manual
- Warranty



Picture of MD 9055 set

# Digital multimeters

## MD 9050 TRMS Heavy Duty Industrial Digital Multimeter



The MD 9050 ranks among the best multimeters on the market. High resolution and accuracy, 2-line LCD display, fast data acquisition and transfer (via optical interface), CAT IV / 1000 V, TRMS current and voltage measurement, non-contact voltage detection, conductance measurement, auto check function and fast one-handed operation are highlights of the multimeter. The MD 9050 is the ideal choice for demanding measurement tasks in industry, in the laboratories and in everyday repair and maintenance practice.

### MEASURING FUNCTIONS

- TRMS AC, DC voltage measurement;
- TRMS AC, DC current measurement;
- Capacitance measurement;
- Resistance measurement;
- Diode test;
- Mains supply frequency measurement;
- Frequency of digital signals measurement;
- Continuity test (acoustic signalling);
- Conductance measurement;
- Electric field detection;
- Temperature measurement.

### KEY FEATURES

- **TRMS:** accurate readings on sinusoidal and non-sinusoidal signals.
- **Autocheck function:** automatic detection of AC voltage, DC voltage or resistance.
- **Auto-ranging:** user can switch between auto and manual ranging.
- **Temperature measurement:** measures T1, T2 and T1 + T2 temperature in Celsius and in Fahrenheit.
- **EF detection:** non-contact and probe-contact electric field detection.
- **Lead alert:** incorrect lead connection alert.
- **Relative zero mode:** relative function for comparing the difference between signals or removing background noise.
- **MAX/MIN/AVG:** recording of maximum, minimum and average values.
- **Data Hold:** data hold feature freezes the display for later view.
- **Peak Hold:** Crest (instantaneous peak) capture mode.
- **PC Link:** test results can be downloaded to the computer via the optional PC software.
- **Safety:** CAT IV / 1000 V overvoltage protection.

- **Backlight:** large bright 4 digits 9999 counts dual LCD display with backlight for working in dark conditions.

### APPLICATION

- High level industrial testing;
- High level electronic fault finding;
- Field servicing;
- Heavy duty electrical testing.

### TECHNICAL DATA

FUNCTION	Range	Accuracy
TRMS AC and AC+DC voltage (40 Hz ... 20 kHz)	60.00 mV ... 999.9 V	from $\pm(0.5\%$ of reading + 3 digits) to $\pm(3.0\%$ of reading + 4 digits)
Autocheck (ACV)	9.999 V ... 999.9 V	$\pm(1.0\%$ of reading + 4 digits)
DC voltage	60.00 mV ... 999.9 V	from $\pm(0.06\%$ of reading + 2 digits) to $\pm(0.12\%$ of reading + 2 digits)
Autocheck (DCV)	9.999 V ... 999.9 V	$\pm(0.5\%$ of reading + 3 digits)
DC current	600.0 $\mu$ A ... 10.00 A	$\pm(0.2\%$ of reading + 4 digits)
TRMS AC and AC+DC current (40 Hz ... 1 kHz)	600.0 $\mu$ A ... 10.00 A	from $\pm(0.6\%$ of reading + 3 digits) to $\pm(1.0\%$ of reading + 4 digits)
Diode test	2.000 V	$\pm(1.0\%$ of reading + 1 digit)
Resistance	Open-circuit voltage <3.5 VDC, test current 0.4 mA	
	600.0 $\Omega$ ... 60.00 M $\Omega$	from $\pm(0.1\%$ of reading + 3 digits) to $\pm(1.5\%$ of reading + 5 digits)
Conductance	99.99 nS	$\pm(0.8\%$ of reading + 10 digits)
Autocheck (resistance)	600.0 $\Omega$ ... 60.00 M $\Omega$	from $\pm(0.5\%$ of reading + 4 digits) to $\pm(2\%$ of reading + 5 digits)
Mains frequency	15.00 Hz ... 50.00 kHz	$\pm(0.04\%$ of reading + 4 digits)
Frequency of digital equipment	5.00 Hz ... 1.000 MHz	$\pm(0.004\%$ of reading + 4 digits)
Capacitance	60.00 nF ... 25.00 mF	from $\pm(0.8\%$ of reading + 3 digits) to $\pm(6.5\%$ of reading + 5 digits)
Temperature	-50 °C ... +1000 °C	$\pm(0.3\%$ of reading + 2 °C)
Power supply	9 V battery (NEDA1604G, JIS006P, or IEC6F22)	
Overvoltage category	CAT IV / 1000 V	
Dimensions	208 x 103 x 64.5 mm	
Weight	635 g	

### STANDARD SET

- **MD 9050**
- Multimeter MD 9050 with rubber holster
- Test lead with probe, 2 pcs
- Thermocouple probe, type K
- 9 V battery
- Instruction manual
- Warranty

# Digital multimeters

## MD 9040 TRMS Industrial Digital Multimeter

CAT IV / 1000 V overvoltage category and TRMS measurement of AC current and voltage are key features of the MD 9040. That's why it is particularly suitable for performing measurements on power supply sources in the most demanding applications in the industrial sector. Its high accuracy, 2-line LCD display, diverse measurement functions, fast one-handed operation and outstanding value for money open up a wide range of possible uses.



### MEASURING FUNCTIONS

- TRMS AC, DC voltage measurement;
- TRMS AC, DC current measurement;
- Capacitance measurement;
- Resistance measurement;
- Diode test;
- Mains supply frequency measurement;
- Frequency of digital signals measurement;
- Continuity test (acoustic signalling).

### KEY FEATURES

- **TRMS:** accurate readings on sinusoidal and non-sinusoidal signals.
- **Lead alert:** incorrect lead connection alert.
- **Auto-ranging:** user can switch between auto and manual ranging.
- **Relative zero mode:** relative function for comparing the difference between signals or removing background noise.
- **Data Hold:** data hold feature freezes the display for later view.
- **PC Link:** test results can be downloaded to the computer via the optional PC software.
- **Frequency measurement:** up to 1 MHz.
- **Safety:** CAT IV / 1000 V overvoltage protection.
- **Easy to read:** large bright 4 digits 9999 counts dual LCD display.

### APPLICATION

- High level industrial testing;
- High level electronic fault finding;
- Field servicing;
- Heavy duty electrical testing.

### STANDARD SET

- **MD 9040**
- Multimeter MD 9040 with rubber holster
- Test lead with probe, 2 pcs
- 9 V battery
- Instruction manual
- Warranty

### TECHNICAL DATA

FUNCTION	Range	Accuracy
TRMS AC voltage (40 Hz ... 20 kHz)	60.00 mV ... 999.9 V	from $\pm(0.5\%$ of reading + 3 digits) to $\pm(3.0\%$ of reading + 4 digits)
DC voltage	60.00 mV ... 999.9 V	from $\pm(0.06\%$ of reading + 2 digits) to $\pm(0.12\%$ of reading + 2 digits)
DC current	600.0 $\mu$ A ... 10.00 A	$\pm(0.2\%$ of reading + 4 digits)
TRMS AC current (40 Hz ... 1 kHz)	600.0 $\mu$ A ... 10.00 A	from $\pm(0.6\%$ of reading + 3 digits) to $\pm(1.0\%$ of reading + 4 digits)
Diode test	2.000 V	$\pm(1.0\%$ of reading + 1 digit)
	Open-circuit voltage <3.5 VDC, Test current 0.4 mA	
Resistance	600.0 $\Omega$ ... 60.00 M $\Omega$	from $\pm(0.1\%$ of reading + 3 digits) to $\pm(1.5\%$ of reading + 5 digits)
Mains frequency	15.00 Hz ... 50.00 kHz	$\pm(0.04\%$ of reading + 4 digits)
Frequency of digital equipment	5.00 Hz ... 1.000 MHz	$\pm(0.004\%$ of reading + 4 digits)
Capacitance	60.00 nF ... 25.00 mF	from $\pm(0.8\%$ of reading + 3 digits) to $\pm(6.5\%$ of reading + 5 digits)
Power supply	9 V battery (NEDA1604G, JIS006P, or IEC6F22)	
Overvoltage category	CAT IV / 1000 V	
Dimensions	208 x 103 x 64.5 mm	
Weight	635 g	

# Digital multimeters

## MD 9030 TRMS General Purpose Digital Multimeter



The MD 9030 TRMS digital multimeter has been designed for use both in the laboratories and in the harsh industrial maintenance and repair sector. TRMS functionality makes the multimeter suitable for a multitude of situations, while the large bright screen with backlight and incorrect lead connection alert make it ideal for working in dark areas.

### MEASURING FUNCTIONS

- TRMS AC, DC voltage measurement;
- TRMS AC, DC current measurement;
- Capacitance measurement;
- Resistance measurement;
- Diode test;
- Frequency measurement;
- Continuity test (acoustic signalling);
- Temperature measurement.

### KEY FEATURES

- **TRMS:** accurate readings on sinusoidal and non-sinusoidal signals.
- **Temperature measurement:** measures temperature in Celsius up to 300 °C and in Fahrenheit up to 572 °F.
- **Frequency measurement:** up to 1 MHz.
- **Lead alert:** incorrect lead connection alert.
- **Auto-ranging:** user can switch between auto and manual ranging.
- **Relative zero mode:** relative function for comparing the difference between signals or removing background noise.
- **Data Hold:** data hold feature freezes the display for later view.
- **MAX Hold:** MAX hold feature freezes the maximum measured value.
- **Safe:** CAT IV / 300 V, CAT III / 600 V and CAT II / 1000 V overvoltage protection.
- **Backlight:** large bright 3-3/4 digits, 4000 counts LCD display with backlight for working in dark conditions.

### APPLICATION

- Mid level electrical testing;
- Mid level electronic fault finding;
- Field servicing;
- General purpose.

### TECHNICAL DATA

FUNCTION	Range	Accuracy
DC voltage	400.0 mV ... 1000 V	from ±(0.3 % of reading + 4 digits) to ±(1.0 % of reading + 4 digits)
TRMS AC voltage (50 ... 500 Hz)	400.0 mV ... 1000 V	from ±(1.5 % of reading + 5 digits) to ±(4.0 % of reading + 5 digits)
DC current	400.0 μA ... 10.00 A	from ±(1.2 % of reading + 3 digits) to ±(2.0 % of reading + 5 digits)
TRMS AC current	400.0 μA ... 10.00 A	from ±(1.5 % of reading + 4 digits) to ±(2.0 % of reading + 6 digits)
Diode test	Open-circuit voltage <1.6 VDC, Test current 0.25 mA	
Resistance	400.0 Ω ... 40.00 MΩ	from ±(0.6 % of reading + 4 digits) to ±(2.0 % of reading + 4 digits)
Temperature	-20 °C ... 300 °C	±(2.0 % of reading + 3 °C)
Frequency	50.00 Hz ... 1.000 MHz	±(0.5 % of reading + 4 digits)
Capacitance	500.0 nF ... 3000 μF	±(3.5 % of reading + 6 digits)
Power supply	2 x 1.5 V batteries, type AAA	
Overvoltage category	CAT IV / 300 V; CAT III / 600 V; CAT II / 1000 V	
Dimensions	198 x 97 x 55 mm	
Weight	396 g	

### STANDARD SET

- MD 9030**
- Multimeter MD 9030 with rubber holster
  - Test lead with probe, 2 pcs
  - 1.5 V battery, type AAA, 2 pcs
  - Instruction manual
  - Warranty



# Digital multimeters

## MD 9020 General Purpose Digital Multimeter

The MD 9020 is a high-quality digital multimeter, designed for everyday use in the laboratory and for maintenance and repair work in the field and in the industrial sector as well.



### MEASURING FUNCTIONS

- AC, DC voltage measurement;
- AC, DC current measurement;
- Capacitance measurement;
- Resistance measurement;
- Diod test;
- Frequency measurement;
- Continuity test (acoustic signalling);
- Temperature measurement.

### KEY FEATURES

- **Temperature measurement:** measures temperature in Celsius up to 300 °C and in Fahrenheit up to 572 °F.
- **Frequency measurement:** up to 1 MHz.
- **Lead alert:** incorrect lead connection alert.
- **Auto-ranging:** user can switch between auto and manual ranging.
- **Relative zero mode:** relative function for comparing the difference between signals or removing background noise.
- **Data Hold:** data hold feature freezes the display for later view.
- **MAX Hold:** MAX hold feature freezes the maximum measured value.
- **Safe:** CAT IV / 300 V, CAT III / 600 V and CAT II / 1000 V overvoltage protection.

### APPLICATION

- Mid level electrical testing;
- Mid level electronic fault finding;
- Field servicing;
- General purpose.

### TECHNICAL DATA

FUNCTION	Range	Accuracy
DC voltage	400.0 mV ... 1000 V	from $\pm(0.3\%$ of reading + 4 digits) to $\pm(1.0\%$ of reading + 4 digits)
AC voltage (50 ... 500 Hz)	400.0 mV ... 1000 V	from $\pm(1.5\%$ of reading + 5 digits) to $\pm(4.0\%$ of reading + 5 digits)
DC current	400.0 $\mu$ A ... 10.00 A	from $\pm(1.2\%$ of reading + 3 digits) to $\pm(2.0\%$ of reading + 5 digits)
AC current	400.0 $\mu$ A ... 10.00 A	from $\pm(1.5\%$ of reading + 4 digits) to $\pm(2.0\%$ of reading + 6 digits)
Diode test	Open-circuit voltage <1.6 VDC, Test current 0.25 mA	
Resistance	400.0 $\Omega$ ... 40.00 M $\Omega$	from $\pm(0.6\%$ of reading + 4 digits) to $\pm(2.0\%$ of reading + 4 digits)
Temperature	-20 °C ... 300 °C	$\pm(2.0\%$ of reading + 3 °C)
Frequency	50.00 Hz ... 1.000 MHz	$\pm(0.5\%$ of reading + 4 digits)
Capacitance	500.0 nF ... 3000 $\mu$ F	$\pm(3.5\%$ of reading + 6 digits)
Power supply	2 x 1.5 V batteries, type AAA	
Overvoltage category	CAT IV / 300 V; CAT III / 600 V; CAT II / 1000 V	
Dimensions	198 x 97 x 55 mm	
Weight	396 g	

### STANDARD SET

#### MD 9020

- Multimeter MD 9020 with rubber holster
- Test lead with probe, 2 pcs
- 1.5 V battery, type AAA, 2 pcs
- Instruction manual
- Warranty

# Digital multimeters

## MD 9016 Electrical Field Service Multimeter



The digital multimeter MD 9016 is a perfect combination of size, innovative functions and built-in PC communication. It is capable to detect and diagnose most electrical and electro technical problems. Display with large easy-to-read figures and one-handed operation make MD 9016 an extremely easy-to-use. This compact instrument combines a high level of functionality and small size and portability.

### MEASURING FUNCTIONS

- AC, DC voltage measurement;
- AC, DC current measurement;
- Capacitance measurement;
- Resistance measurement;
- Diode test;
- Frequency measurement;
- Continuity test (acoustic signalling);
- Electric field detection;
- Temperature measurement.

### KEY FEATURES

- **Auto-ranging:** user can switch between auto and manual ranging.
- **EF detection:** non-contact and probe contact electric field detection.
- **Relative zero mode:** relative function for comparing the difference between signals or removing background noise.
- **Hold:** data hold function freezes the display for later view.
- **PC Link:** test results can be downloaded to the computer via the optional PC software.
- **Safe:** CAT II / 1000 V, CAT III / 600 V and CAT IV / 300 V overvoltage protection.

### APPLICATION

- HVAC (heating, ventilation and air conditioning) troubleshooting;
- Low level electrical testing;
- Low level electronic fault finding;
- Basic field servicing;
- Hobby work.

### TECHNICAL DATA

FUNCTION	Range	Accuracy
DC Voltage	60.00 mV ... 1000 V	from ±(0.4% of reading + 5 digits) to ±(0.2% of reading + 3 digits)
AC Voltage (50 Hz ... 500 Hz)	60.00 mV ... 1000 V	±(1.0% of reading + 5 digits)
DC Current	600.0 μA ... 10.00 A	from ±(0.5% of reading + 5 digits) to ±(1.8% of reading + 6 digits)
AC Current (50 Hz ... 400 Hz)	600.0 μA ... 10.00 A	from ±(1.0% of reading + 3 digits) to ±(1.8% of reading + 6 digits)
Diode Test	1.000 V	±(1.0% of reading + 3 digits)
Resistance	Open-circuit voltage < 1.8 V DC, Test current 0.56 mA 600.0 Ω ... 60.00 MΩ	from ±(0.5% of reading + 4 digits) to ±(1.2% of reading + 4 digits)
Capacitance	60.00 nF ... 3000 μF	from ±(1.5% of reading + 5 digits) to ±(2.0% of reading + 5 digits)
Temperature	-50 °C ... 1000 °C -58 °F ... 1832 °F	±(0.3% of reading + 3 digits) ±(0.3% of reading + 6 digits)
Frequency of digital equipment	5.00 Hz ... 1.000 MHz	±(0.003% of reading + 2 digits)
Mains frequency	10 Hz ... 50 kHz	±(0.003% of reading + 3 digits)
Power supply	2 x 1.5 V batteries, type AAA	
Overvoltage category	CAT IV / 300 V; CAT III / 600 V; CAT II / 1000 V	
Dimensions	161 x 80 x 50 mm	
Weight	340 g	

### STANDARD SET

- **MD 9016**
- Multimeter MD 9016 with rubber holster
- Test lead with probe, 2 pcs
- Thermocouple probe, type K
- 1.5 V battery, type AAA, 2 pcs
- Instruction manual
- Warranty

# Digital multimeters

## MD 9010 General Purpose Autocheck Digital Multimeter

The MD 9010 is one of the smallest and lightest of our digital multimeters. The MD 9010 unit can be used for a wide variety of applications. The high accuracy, LCD display and features including non-contact voltage detection and an autocheck function make the multimeter extremely versatile and great value for money.



### MEASURING FUNCTIONS

- AC, DC voltage measurement;
- AC, DC current measurement;
- Capacitance measurement;
- Resistance measurement;
- Diode test;
- Frequency measurement;
- Continuity test;
- Electric field detection.

### KEY FEATURES

- **Autocheck function:** automatic detection of AC voltage, DC voltage or resistance.
- **Auto-ranging:** no need of manual ranging.
- **Pocket-sized:** small, thin, ergonomic design.
- **Lightweight:** 78 g only.
- **Acoustic signalling** on continuity test.
- **EF detection:** non-contact and probe-contact electric field detection.
- **Safe:** protected against wrong connection and overvoltage (CAT III / 300 V and CAT II / 600 V).
- **Easy to read:** LCD display, 3-5/6 digits, 6000 counts.

### APPLICATION

- Low level electrical testing;
- Low level electronic fault finding;
- Basic field servicing;
- Hobby work.

### TECHNICAL DATA

FUNCTION	Range	Accuracy
DC voltage	6.000 V ... 600.0 V	from $\pm(0.5\%$ of reading + 3 digits) to $\pm(2.0\%$ of reading + 5 digits)
AC voltage (50 ... 60 Hz)	6.000 V ... 600.0 V	$\pm(1.5\%$ of reading + 5 digits)
DC current	400.0 $\mu$ A 2000 $\mu$ A	$\pm(1.5\%$ of reading + 3 digits) $\pm(1.2\%$ of reading + 3 digits)
AC current	400.0 $\mu$ A 2000 $\mu$ A	$\pm(2.0\%$ of reading + 3 digits) $\pm(1.5\%$ of reading + 3 digits)
Diode test	Open-circuit voltage <1.6 VDC	
Resistance	600.0 $\Omega$ ... 6.000 M $\Omega$	from $\pm(1.0\%$ of reading + 4 digits) to $\pm(2.0\%$ of reading + 6 digits)
Frequency	10.00 Hz ... 30.00 kHz	$\pm(0.5\%$ of reading + 4 digits)
Capacitance	100.0 nF ... 2000 $\mu$ F	$\pm(3.5\%$ of reading + 6 digits)
Power supply	3 V button battery (IEC-CR2032)	
Overvoltage category	CAT III / 300 V; CAT II / 600 V	
Dimensions	113 x 53 x 10.2 mm	
Weight	78 g	



### STANDARD SET



#### MD 9010

- Multimeter MD 9010 with rubber holster
- Test lead with probe, 2 pcs
- Battery
- Instruction manual
- Warranty

# Clamp Meters

## Selection Guide for Clamp Meters

FEATURES	Description	MD 9273 Current Meter <b>NEW</b>	MD 9272 Current Meter	MD 9260 Current Meter <b>NEW</b>
				
<b>MEASUREMENTS</b>	Clamp type	AC	AC	AC/DC
	True RMS	•	•	•
	Counts	3000	3000	6000
	Best update rate (/s)	2	2	5
	AC current ranges (A)	40mA ... 100 A	40mA ... 100 A	200 A ... 2000 A
	Best accuracy (%)	0,8	0,8	2
	DC current range (A)			200 A ... 2000 A
	Best accuracy (%)			2
	Low range AmpTip clamp AC/DC			
	Best accuracy (%)			
	AC voltage ranges (V)	40V ... 600 V	40V ... 600 V	6 V ... 1000 V
	Best accuracy (%)	0.5	0.5	1.2
	DC voltage ranges (V)			6 V ... 1500 V
	Best accuracy (%)			0.5
	Resistance ranges ( $\Omega$ )			40.00 M $\Omega$
	Best accuracy (%)			0.5
	Capacitance ranges			60 nF ... 2000 $\mu$ F
	Best accuracy (%)			2
	Frequency max range	45.00 Hz ... 100 Hz	45.00 Hz ... 100 Hz	40.00 Hz ... 1999.9 Hz
	Best accuracy (%)	0.05	0.05	0.1
	Acoustic continuity test			•
	Range selection	Auto	Auto	Auto/manual
	Diode test			•
	Temperature measurement (Type K probe)			-50°C ... 1000°C
<b>SPECIAL FEATURES</b>	Bluetooth®	•		
	Inrush current	•		
	Power and power factor measurement (W, VA, VAR)	•	•	
	Energy kWh recording			
	3-phase power measurement			
	Autocheck®			
	Lo-Z (low input impedance)			
	Filter for frequency measurement		Variable frequency drive	Variable frequency drive
	3-phase rotation detection			
	Non-contact electrical field detection			•
	Harmonic analysis	•	•	
	Notch filter at 128 Hz	•		
	Backlight	•	•	•
	Flashlight			
	COM port (data transfer)			•
	MAX/MIN/AVG hold	MAX/MIN	MAX/MIN	MAX
	Fast data hold - Peak hold	25 $\mu$ s	25 $\mu$ s	5 ms
	Data hold	•	•	•
	Relative value			•
	Automatic switch off	•	•	•
<b>GENERAL</b>	Jaw opening	28 mm	28 mm	55 mm
	Overvoltage category	CAT IV / 300 V CAT III / 600 V	CAT IV / 300 V CAT III / 600 V	CAT III / 1500 V CAT IV / 1000 V
	Dimensions (mm)	190 x 60 x 13	190 x 60 x 13	264 x 97 x 43
	Weight (g)	255	255	608
	IP	IP 40	IP 40	IP 40
	CE mark	•	•	•

MD 9250 Current Meter	MD 9240 Current Meter	MD 9235 Current Meter	MD 9231 Current Meter	MD 9226 Current Meter	MD 9210 Current Meter
					
AC/DC	AC	AC	AC/DC	AC/DC	AC
•	•	•	•	•	•
6000	4000, 6000, 9999	6000	6000	6000	4000
5	4	2	5	5	3
200 A ... 2000 A	40 A ... 1000 A	40 A ... 600 A	60 A ... 1000 A	60 A ... 600 A	600 A
2	1	1	1.8	1.8	1.5
200 A ... 2000 A			60A ... 1000A	60 A ... 600 A	
2			1.5	2.0	
			20 A/60 A	60 A/60 A	
			1.5	1.5	
6 V ... 1000 V	600 V	600 V	600 V, 1000 V	600V	600 V
1.2	0.5	0.5	0.8	1.0	1.5
6 V ... 1000 V	600 V	600 V	600 V, 1000 V	600V	600 V
0,5	0,5	0,5	0.8	1.2	0.3
40.00 MΩ	999.9 Ω	999.9 Ω	600 Ω ... 60 kΩ	600 Ω ... 60 kΩ	400 Ω ... 40 MΩ
0,5	1	1	1	1	0,6
60 nF ... 2000 μF			200 μF, 2500 μF	200 μF, 2500 μF	
2			2.0	2.0	
40.00 Hz ... 1999.9 Hz	5.00 Hz ... 500 Hz	5.00 Hz ... 500 Hz	5.00 Hz ... 999.9 Hz	5.00 Hz ... 999.9 Hz	10 ... 100 kHz
0.1	0.5	0.5	1	1	0.5
•	•	•	•	•	•
Auto/manual	Auto	Auto	Auto	Auto	Auto
•			•	•	•
-50°C ... 1000°C	-50°C ... 300°C				
	•	•			
		•			
		•			
V-Ω	V-A	V-A	V-Ω		
•			•		
Variable frequency drive			Variable frequency drive	Variable frequency drive	
•			•	•	
•	•	•	•	•	
			•		
•	•	•			
MAX	MAX	MAX	MAX/MIN/AVG	MAX/MIN/AVG	MAX
5 ms	65 ms	65 ms	5 ms	80 ms	30ms
•	•	•	•	•	•
•			•	•	•
•	•	•	•	•	•
55 mm	45 mm	26 mm	51mm	35mm	26 mm
CAT IV / 1000 V	CAT IV / 300 V CAT III / 600 V	CAT IV / 300 V CAT III / 600 V	CAT IV / 600 V CAT III / 1000 V	CAT IV / 300 V CAT III / 600 V	CAT IV / 300 V CAT III / 600 V
264 x 97 x 43	224 x 78 x 40	189 x 78 x 40	258 x 94 x 44	223 x 76 x 37	190 x 63 x 32
608	224	192	392	234	139
IP 40	IP 40	IP 40	IP40	IP40	IP 40
•	•	•	•	•	•

# Clamp Meters

## MD 9273 Bluetooth® TRMS Leakage Clamp with Power Functions

NEW

Clamp Meters



The MD 9273 is the new Bluetooth-enabled expansion to the Metrel multifunctional testers MI 3155, MI 3152 and MI 3325. When used together, they form a team for measuring data from a safe distance. The multifunctional instruments can record inrush current from MD 9273 measurement and display data in table or graph form, or they can be used to generate a 128 Hz signal that MD 9273 can filter and follow for cable tracing. When acting as a remote probe, it can send data on current, voltage, power, and harmonics. On the other hand, it is an independent instrument with improved accuracy, construction, and new functions like VFD filter. It can accurately read the TRMS AC leakage current of a system, detect losses in the system, suggest possible reasons for the loss, sense the harmonics in the signal, and perform basic power quality tests.

### MEASURING FUNCTIONS

- TRMS AC and DC voltage measurement;
- TRMS AC current measurement;
- Frequency measurement;
- VFD frequency and voltage measurement;
- Harmonics measurement;
- Power parameters measurement.

### KEY FEATURES

- **Bluetooth** connection to MI 3155, MI 3152 and MI 3325.
- **Inrush current** recording with MI 3155, MI 3152 and MI 3325.
- **Online measurements** of current, voltage, power, current harmonics, and voltage harmonics.
- **128 Hz notch** filter for cable tracing.
- **TRMS**: accurate measurements on sinusoidal and non-sinusoidal signals.
- **Jaw size**: 28 mm.
- **Shielded jaw**: shielded jaw allows the clamp meter to be used in the noisiest environments.
- **Accurate**: readings of AC current with an accuracy of 0.8 % and a base resolution of 0.01 mA and voltage with an accuracy of 0.5 % and a base resolution of 0.01 V.
- **Power**: measures various power parameters (active, reactive, apparent power, PF, phase displacement).
- **Intelligent loss analysis**: complex algorithms detect loss and allow determining possible reasons for current loss.
- **Harmonics**: measures current or voltage harmonic components and a percentage value of a harmonic up to the 19th.
- **THD and PF**: dual display allows readings

to be displayed along with Total Harmonic Distortion (THD) or Power Factor (PF).

- **Peak value**: the peak value of the waveform or crest factor can be displayed.
- **MAX/MIN/HOLD mode**: displays maximum, minimum or last measured value.

### APPLICATION

- Basic power quality analysis.
- Troubleshooting in installations.
- Troubleshooting of devices and machines.
- Electric vehicles troubleshooting.

### TECHNICAL DATA

FUNCTION	Ranges	Resolution	Accuracy
Current AC	40 mA ... 100 A	0.01 mA	± 0.8 % of reading ± 3 digits
Voltage AC, DC	40 V ... 600 V	0.01 V	± 0.5 % of reading ± 4 digits
THD	0 ... 999 %	0.1 %	± 2 % of reading ± 3 digits
Frequency	10 ... 100 Hz	0.1 Hz	± 0.1 % ± 2 digits
Current Harmonics	0 ... 100% Irange	N/A	± 0.15 % × Irange ± 3 digits
Voltage harmonics	0 ... 100% Urange	N/A	± 0.1 % × Urange ± 2 digits
Crest factor voltage/current	1.00 ... 9.99	0.01	± 2 % of reading ± 2 digits
Peak value voltage	40 V ... 600 V	0.01 V	± 5 % of reading ± 5 digits
Peak value current	40 mA ... 100 A	0.01 mA	± 5 % of reading ± 5 digits
VFD	40 V ... 600 V	0.01 V	± 2 % of reading ± 2 digits
Power	0.000 W ... 60 kW	0.001 W	± 1 % of reading ± 50 digits
PF	0.00 ... 1.00	0.01	± 5 digits
Phase	-180.0 ... 180.0	0.1	± 30 digits
Power Supply	2 × 1.5 V AAA alkaline battery		
Overvoltage category	CAT IV / 300 V, CAT III / 600 V		
Dimensions	185 mm x 62 mm x 42 mm		
Weight	210 g		

- General purpose.
- Cable tracing.

### STANDARD SET

#### MD 9273

- MD 9273 Bluetooth® TRMS Leakage Clamp with Power Functions
- Test lead with probe, 2 pcs
- Alligator clip, 2 pcs
- 1.5 V battery, type AA, 2 pcs
- Pouch
- Instruction manual
- Calibration certificate

# Clamp meters

## MD 9272 Leakage Clamp TRMS Meter with Power Functions

The MD 9272 is a unique earth leakage clamp meter. It not just has the ability to accurately read the TRMS AC leakage current of a system, it can also detect losses in the system and suggest possible reasons for the loss. The voltage, power, harmonic, power factor (PF), total harmonic distortion (THD) and crest factor measurements make this instrument suitable for any electrician and engineer.



### MEASURING FUNCTIONS

- TRMS AC and DC voltage measurement;
- TRMS AC current measurement;
- Frequency measurement;
- Power parameters measurement.

### KEY FEATURES

- **TRMS:** accurate measurements on sinusoidal and non-sinusoidal signals.
- **Jaw size:** 28 mm.
- **Shielded jaw:** shielded jaw allows the clamp meter to be used in the noisiest environments.
- **Accurate:** readings of AC current with an accuracy of 0.8 % and a base resolution of 0.01 mA and voltage with an accuracy of 0.5 % and a base resolution of 0.01 V.
- **Power:** measures various power parameters (active, reactive, apparent power, THD, PF, phase displacement).
- **Intelligent loss analysis:** complex algorithms detect loss and allow determining possible reasons for current loss.
- **Harmonics:** measures current or voltage harmonic components and a percentage value of a harmonic up to the 19<sup>th</sup>.
- **THD and PF:** dual display allows readings to be displayed along with Total Harmonic Distortion (THD) or Power Factor (PF).
- **Peak value:** the peak value of the waveform or crest factor can be displayed.
- **MAX/MIN/HOLD mode:** displays maximum, minimum or last measured value.

### APPLICATION

- Load and leakage current measurement;
- System maintenance;
- Power system checking;
- RCD fault finding;
- Process engineering.

### STANDARD SET

- MD 9272**
- Current clamp MD 9272
  - Test lead with probe, 2 pcs
  - 1.5 V battery, type AAA, 2 pcs
  - Pouch
  - Instruction manual
  - Warranty

### TECHNICAL DATA

FUNCTION	Ranges	Resolution	Accuracy
Current AC	40 mA ... 100 A	0.01 mA	± 0.8 % of reading ± 3 digits
Voltage AC, DC	40 V ... 600 V	0.01 V	± 0.5 % of reading ± 4 digits
THD	0 ... 999 %	0.1 %	± 2 % of reading ± 3 digits
Frequency	10 ... 100 Hz	0.1 Hz	± 0.1 % ± 2digit
Current Harmonics	0 ... 100 % Irange	N/A	± 0.15 % × Irange ± 3 digits
Voltage harmonics	0 ... 100 % Urange	N/A	± 0.1 % × Urange ± 2 digits
Crest factor voltage/current	1.00 ... 9.99	0.01	± 2 % of reading ± 2 digits
Peak value voltage	40 V ... 600 V	0.01 V	± 5 % of reading ± 5 digits
Peak value current	40 mA ... 100 A	0.01 mA	± 5 % of reading ± 5 digits
Power	0.000 W ... 60 kW	0.001 W	± 1 % of reading ± 50 digits
PF	0.00 ... 1.00	0.01	± 5 digits
Phase	-180.0 ... 180.0	0.1	± 30 digits
Power Supply	2 x 1,5 V AAA alkaline battery		
Overvoltage category	CAT IV / 300 V, CAT III / 600 V		
Dimensions	185 mm x 62 mm x 42 mm		
Weight	210 g		

# Clamp Meters

## MD 9260 TRMS Photovoltaic Clamp Meter CAT III 1500 VDC

NEW

Clamp Meters



The MD 9260 is the first Metrel instrument to support measurements up to 1500 V with CAT III safety. Its voltage range and safety make it useful in highly demanding environments like solar power plants, wind power plants, or other high power environment using DC current. It has 2000 A AC/DC current range and can additionally measure resistance, capacitance, frequency and temperature – in short a well-rounded multimeter-style tool for use in power applications.

### MEASUREMENT FUNCTIONS

- TRMS AC and DC voltage measurement;
- TRMS AC and DC current measurement;
- Capacitance measurement;
- Resistance measurement;
- Frequency measurement with VFD;
- Diode test;
- Temperature measurement;
- Acoustic continuity;
- Non-contact electrical field detection.

### KEY FUNCTIONS

- **1500 V DC range** with CAT III safety.
- **TRMS** for accurate measurement of sine and non-sine signals.
- **VFD**: low-pass filter for accurate frequency measurements of noisy signals.
- High current range of **2000 A**.
- **CAT III 1500 VDC** and **CAT IV 1000 V** safety
- Protection against **12 kV transients**.
- **Auto and manual** ranging.
- **Relative zero**: easily compare consecutive measurements.
- **Crest** function catches peaks as short as 5 ms.
- **Temperature** measurements up to 1000 °C.
- **PC connection** (optional): logging directly to a PC.

### APPLICATIONS

- Testing solar power systems up to 1500 V.
- Testing wind power systems.
- High level industrial testing.
- Testing of UPS and other large battery systems.

### TECHNICAL DATA

FUNCTION	Range	Accuracy
DC Voltage	6.000 V ... 1500 V	±(0.5 % of reading + 5 digits)
AC Voltage (50 Hz ... 400 Hz)	6.000 V ... 1000 V	±(1.2 % of reading + 5 digits)
AC+DC Voltage (DC, 50Hz ... 400 Hz)	6.000 V ... 1000 V	±(1.4 % of reading + 7 digits)
Variable Frequency Drive AC	10 Hz ... 400 Hz	±(2.0 % of reading + 60 digits)
DC Current	200.0 A ... 2000 A	±(2.0 % of reading + 5 digits)
AC Current (50 Hz ... 400 Hz)	200.0 A ... 2000 A	±(2.0 % of reading + 5 digits)
Resistance	600.0 Ω ... 40.00 MΩ	±(0.5 % of reading + 5 digits)
Capacitance	60.00 nF ... 2000 μF	±(2.0 % of reading + 5 digits)
Temperature	-50 °C ... 1000 °C	±(0.3 % of reading + 4 digits)
	-58 °F ... 1832 °F	±(0.3 % of reading + 6 digits)
Mains frequency	10 Hz ... 1999 Hz	±(0.1 % of reading + 4 digits)
Diode Test	1.000 V	±(1.0 % of reading + 3 digit)
Power supply	2 x 1.5 V batteries, type AA	
Overvoltage category	CAT IV / 1000 V, CAT III 1500 V	
Dimensions	264 x 97 x 43 mm	
Weight	608 g	

### STANDARD SET

#### MD 9260

- MD 9260 Photovoltaic current clamp 1500 VDC
- AMD 9026 Test lead with probe, 2 pcs
- AMD 9023 Thermocouple probe type K
- 1.5V AAA battery, 2 pcs
- User manual



# Clamp meters

## MD 9250 Industrial TRMS AC/DC CAT IV /1000 V

The MD 9250 is the first Clamp Meter that meets overvoltage category CAT IV 1000 V. MD 9250 is a high quality clamp meter specially designed for single-hand operation, built-in measuring functions; TRMS AC/DC (current, voltage), capacitance, temperature and full range resistance makes this instrument an ideal tool for the most demanding applications in the industrial sector. The large jaws capacity of (max. 55 mm) in diameter allows AC/DC - current measurements up to 2000 A. High resolution and accuracy, 2-line LCD display fast data acquisition and transfer (via optical interface), non-contact voltage detection, and auto-check function are highlights of the instrument.



### MEASURING FUNCTIONS

- TRMS AC, DC voltage measurement;
- TRMS AC, DC current measurement;
- Capacitance measurement;
- Resistance measurement;
- Diode test;
- Frequency measurement;
- Electric field detection;
- Continuity test (acoustic signalling);
- Temperature measurement.

### KEY FEATURES

- **Large jaws:** for measuring on 55mm size conductors.
- **TRMS:** accurate measurements on sinusoidal and non-sinusoidal signals.
- **VFD:** feature makes the instrument capable of measuring the true values in accordance with frequency.
- **High current:** 2000 A DC & AC clamp on measurement.
- **Lo-Z:** AutoCheck® mode provides low (ramp-up) input impedance to drain ghost voltages.
- **Auto-check function:** automatic detection of AC voltage, DC voltage or resistance.
- **Auto-ranging:** user can switch between auto and manual ranging.
- **Transient protection:** it protects user in case of lightning strike or switching surge up to 12 kV.
- **Relative zero mode:** relative function for comparing the difference between signals or removing background noise.
- **PC Link:** test results can be downloaded to the computer via the optional PC software.
- **In-rush:** fast 5ms Crest-MAX mode to capture in-rush currents.
- **Temperature:** measures temperature in Celsius up to 1000 °C and in Fahrenheit up to 1832 °F.
- **Hold:** data hold function freezes the display for later view.
- **Backlight:** large bright 3-5/6 digits 6,000 counts + 1,999 counts dual LCD display with backlight for working in dark conditions.
- **Safe:** CAT IV / 1000 V overvoltage protection.

### APPLICATION

- Solar and wind power system testing;
- UPS system testing;
- Utility scale battery system testing;
- High level industrial testing;
- High level electrical testing.

### TECHNICAL DATA

FUNCTION	Range	Accuracy
DC Voltage	6.000 V ... 1000 V	±(0.5% of reading + 5 digits)
Autocheck (DCV)	6.000 V ... 1000 V	±(1.3% of reading + 5 digits)
AC Voltage (50 Hz ... 400 Hz)	6.000 V ... 1000 V	±(1.2% of reading + 5 digits)
AC+DC Voltage (DC, 50Hz ... 400 Hz)	6.000 V ... 1000 V	±(1.4% of reading + 7 digits)
Autocheck (ACV)	6.000 V ... 1000 V	±(1.5% of reading + 5 digits)
Variable Frequency Drive AC	10 Hz ... 400 Hz	from ±(4.0% of reading + 80 digits) to ±(7.0% of reading + 80 digits)
DC Current	200.0 A ... 2000 A	from ±(2.0% of reading + 5 digits) to ±(2.5% of reading + 5 digits)
AC Current (50 Hz ... 400 Hz)	200.0 A ... 2000 A	from ±(2.0% of reading + 5 digits) to ±(3.5% of reading + 5 digits)
Diode Test	1.000 V Open-circuit voltage < 1.8 V DC, Test current 0.56 mA	±(1.0% of reading + 3 digit)
Resistance & Autocheck	600.0 Ω ... 40.00 MΩ	from ±(0.5% of reading + 5 digits) to ±(2.3% of reading + 5 digits)
Capacitance	60.00 nF ... 2000 μF	from ±(2.0% of reading + 5 digits) to ±(4.0% of reading + 5 digits)
Temperature	-50 °C ... 1000 °C -58 °F ... 1832 °F	±(0.3% of reading + 4 digits) ±(0.3% of reading + 6 digits)
Mains frequency	10 Hz ... 1999 Hz	±(0.1% of reading + 4 digits)
Power supply	2 x 1.5 V batteries, type AA	
Overvoltage category	CAT IV / 1000 V	
Dimensions	264 x 97 x 43 mm	
Weight	608 g	

### STANDARD SET

#### MD 9250

- Current clamp MD 9250
- Test lead with probe, 2 pcs
- Thermocouple probe, type K
- Pouch
- 1.5 V battery, type AAA, 2 pcs
- Instruction manual
- Warranty

# Clamp Meters

## MD 9240 TRMS Power Clamp Meter



The MD 9240 is a high-quality and extremely easy to handle power clamp meter. The MD 9240 enables TRMS AC current measurement up to 1000 A, AC and DC voltage measurement, single-phase power analysis, temperature measurement and more. As a result the current clamp meter is suitable for maintenance and checking of distribution systems, switchboards and motors or systems where the supply network is heavily contaminated with harmonics.

### MEASURING FUNCTIONS

- TRMS AC, DC voltage measurement;
- TRMS AC current measurement;
- Frequency measurement;
- Resistance measurement;
- Continuity test;
- Temperature measurement;
- Power parameters measurement.

### KEY FEATURES

- **TRMS:** accurate measurements on sinusoidal and non-sinusoidal signals.
- **Jaw size:** 45 mm.
- **High current:** measures up to 1000 A AC.
- **Autocheck function:** automatic detection of AC voltage, DC voltage or AC current.
- **Power:** measures various power parameters (active, reactive, apparent power, PF).
- **Temperature:** measures temperature in Celsius up to 300 °C and in Fahrenheit up to 572 °F.
- **PC Link:** test results can be downloaded to the computer via the optional PC software.
- **Data Hold:** data hold feature freezes the display for later view.
- **Peak Hold:** peak hold feature displays maximum RMS value of surge voltage or current.

### APPLICATION

- System maintenance;
- Power system checking;
- High level Industrial testing;
- High level electrical testing.

### STANDARD SET

#### MD 9240

- Current clamp MD 9240
- Test lead with probe, 2 pcs
- Thermocouple probe, type K
- 1.5 V battery, type AAA, 2 pcs
- Pouch
- Instruction manual
- Warranty

### TECHNICAL DATA

FUNCTION	Range	Accuracy
DC voltage	600.0 V	±(0.5 % of reading + 5 digits)
AC voltage (50 ... 60 Hz; 45 ... 500 Hz; 500 Hz ... 3.1 kHz)	600.0 V	from ±(0.5 % of reading + 5 digits), to ±(2.5 % of reading + 5 digits)
AC current (50 ... 60 Hz)	40.00 A, 400.0 A, 1000 A	±(1.0 % of reading + 5 digits)
AC current (45 ... 500 Hz)	40.00 A, 400.0 A, 1000 A	±(2.0 % of reading + 5 digits) ±(2.5 % of reading + 5 digits)
AC current (500 Hz ... 3.1 kHz)	40.00 A, 400.0 A, 1000 A	±(2.5 % of reading + 5 digits) ±(3.0 % of reading + 5 digits)
Temperature	-50 °C ... 300 °C	±(2.0 % of reading + 3 °C)
Resistance	999.9 Ω	±(1.0 % of reading + 6 digits)
Continuity test	10 ... 300 Ω	
Frequency	5.00 Hz ... 500.0 Hz	±(0.5 % of reading + 4 digits)
Power factor (PF)	0.10 ... 0.99	±(3 digits), H from 1. to 21. ±(5 digits), H from 22. to 51.
Apparent power	0 ... 600.0 kVA	±(2.0 % of reading + 6 digits), H 1./10. ±(3.5 % of reading + 6 digits), H 11./46. ±(5.5 % of reading + 6 digits), H 47./51.
Active power, reactive power	0 ... 600.0 kW, kVar	from ±(2.0 % of reading + 6 digits)
Power supply	2 x 1.5 V batteries, type AAA	
Overvoltage category	CAT IV / 300 V; CAT III / 600 V	
Dimensions	224 x 78 x 40 mm	
Weight	224 g	

# Clamp meters

## MD 9235 TRMS Power Clamp Meter, 3-Phase, Unbalanced-Load

The MD 9235 is a Slim-Jaw current clamp meter with ability to measure 3-Phase Unbalanced-Load + kWhr recording. The MD 9235 enables TRMS AC current measurement up to 600 A, single and 3-phase power analysis, total power factor and resistance measurement. Display with large easy-to-read figures and one-handed operation make MD 9235 an extremely easy-to-use. This compact instrument combines a high level of functionality, small size and portability. All built-in features make MD 9235 a perfect tool for advanced Power applications.



### MEASURING FUNCTIONS

- TRMS AC, DC voltage measurement;
- TRMS AC current measurement;
- Resistance measurement;
- Frequency measurement;
- Continuity test (acoustic signalling);
- Power parameters measurement.

### KEY FEATURES

- **Slim-Jaws:** ultra-slim jaws to access tight places.
- **TRMS:** accurate measurements on sinusoidal and non-sinusoidal signals.
- **kWhr:** Kilo-Watt-Hour recording function (with memory recall).
- **Peak Hold:** peak hold feature displays maximum RMS value of surge voltage or current.
- **Jaw size:** 26 mm.
- **Transient protection:** it protects user in case of lightning strike or switching surge up to 6.5 kV.
- **Hold:** data hold function freezes the display for later view.
- **Safe:** CAT IV / 300 V, CAT III / 600 V overvoltage protection.

### APPLICATION

- Power system checking;
- High level industrial testing;
- High level electrical testing.

### STANDARD SET

- MD 9235**
- Current clamp MD 9235
  - Test lead with probe, 2 pcs

- Pouch
- 1.5 V battery, type AAA, 2 pcs
- Instruction manual
- Warranty

### TECHNICAL DATA

FUNCTION	Range	Accuracy
DC Voltage	600.0 V	±(0.5% of reading + 5 digits)
AC Voltage (50 Hz ... 3.1 kHz)	600.0 V	from ±(0.5% of reading + 5 digits) to ±(2.5% of reading + 5 digits)
AC Current (40 Hz ... 3.1 kHz)	40.00 A ... 600 A	from ±(1.0% of reading + 5 digits) to ±(3.0% of reading + 5 digits)
Resistance	999.9 Ω	±(1.0% of reading + 6 digits)
Apparent power	0 kVA ... 600.0 kVA	±(2.0% of reading + 6 digits), H 1./10. ±(3.5% of reading + 6 digits), H 11./46. ±(5.5% of reading + 6 digits), H 46./51.
Active power, reactive power	0 kVA ... 600.0 kW, kVar	from ±(2.0% of reading + 6 digits) to ±(10.0% of reading + 6 digits), H 1./10. from ±(3.5% of reading + 6 digits) to ±(10.0% of reading + 6 digits), H 11./25. from ±(4.5% of reading + 6 digits) to ±(15.0% of reading + 6 digits), H 26./45. from ±(10.0% of reading + 6 digits) to ±(15.0% of reading + 6 digits), H 46./51.
Power factor (PF)	0.10 ... 0.99	±(3 digits), H 1./21. ±(5 digits), H 22./51.
Mains frequency	5 Hz ... 500 Hz	±(0.5% of reading + 4 digits)
Power supply	2 x 1.5 V batteries, type AAA	
Overvoltage category	CAT IV / 300 V, CAT III / 600 V	
Dimensions	189 x 78 x 40 mm	
Weight	192 g	

# Clamp Meters

## MD 9231 Industrial TRMS AC/DC Current Clamp Meter



The MD 9231 is an industrial TRMS AC and DC current clamp meter with a wide jaw opening and is capable of measuring currents up to 1000 A. It has the ability to measure capacitance and frequency and is equipped with a built-in VFD feature that makes the instrument capable of measuring the true values in accordance with frequency. The MD 9231 has a wide range of extra features, including peak value, data and MAX hold functions, auto power off, auto-ranging and a relative zero function. It uses state-of-the-art measurement technology and is housed in a sturdy industrial-grade case. It also has a flashlight for work in dark conditions.

### MEASURING FUNCTIONS

- DC and TRMS AC voltage measurement up to 1000 V;
- DC and TRMS AC current measurement up to 1000 A;
- Resistance measurement;
- Acoustic continuity test;
- Diode test;
- Frequency measurement;
- Capacitance measurement.

### KEY FEATURES

- **Auto-ranging.**
- LCD display with **backlight**, 3-5/6 digit, 6000 count.
- **Flashlight.**
- **AmpTip™ Low current & Hz:** clamp tip for measuring AC and DC current up to 60 A.
- Automatic, **non-contact detection** of electromagnetic fields to locate and trace live conductors.
- **Data hold** function.
- **MIN/MAX/AVG** function.
- **Relative zero.**
- **51 mm** jaw opening.
- **CAT IV / 600 V**, CAT III / 1000 V overvoltage categories.

### APPLICATION

- System maintenance;
- Power system checking;
- High level industrial testing;
- High level electrical testing.

### STANDARD SET

- MD 9231**
- Current clamp MD 9231
  - Test lead, 2 pcs

- Battery, 2 pcs
- Pouch
- Instruction manual
- Warranty

### TECHNICAL DATA

FUNCTION	Range	Accuracy
DC Voltage	600.0 V ... 1000.0 V	±(0.8% of reading + 5 digits)
AC Voltage	600.0 V ... 1000.0 V	from ±(0.8% of reading + 5 digits) to ±(1.0% of reading + 5 digits)
(50 Hz ... 400 Hz)		
DC+AC Voltage	600.0 V ... 1000.0 V	from ±(1.0% of reading + 7 digits) to ±(1.2% of reading + 7 digits)
(DC, 50 Hz ... 400 Hz)		
PEAK-rms (ACV & ACA)	Response: 80 ms to > 90%.	
CREST (Peak-Hold)	Accuracy: Add 250 digits to specified accuracy for changes > 5ms	
Audible Continuity Tester	Audible Threshold: At between 10 Ω and 250 Ω. Response time: 32 ms approx.	
Ohm	600.0 Ω, 6.000 kΩ, 60.00 kΩ	±(1.0% of reading + 5 digits)
Capacitance	200.0 μF, 2500 μF	±(2.0% of reading + 4 digits)
Diode Tester	2.000 V	±(1.5% of reading + 5 digits)
AmpTip™ clamp-on DCA	00.00 A ... 60.00 A	from ±(1.5% of reading + 5 digits) to ±(3.0% of reading + 5 digits)
AmpTip™ clamp-on ACA	00.00 A ... 60.00 A	from ±(1.5% of reading + 5 digits) to ±(3.0% of reading + 5 digits)
(40 Hz ... 400 Hz)		
AmpTip™ clamp-on DC+ACA	00.00 A ... 60.00 A	from ±(2.0% of reading + 7 digits) to ±(3.0% of reading + 7 digits)
(DC, 40 Hz ... 400 Hz)		
Regular Clamp-on DCA	60.00 A ... 1000 A	±(1.8% of reading + 5 digits)
Regular Clamp-on ACA	60.00 A ... 1000 A	from ±(1.8% of reading + 5 digits) to ±(2.2% of reading + 5 digits)
(40 Hz ... 400 Hz)		
Regular Clamp-on DC+ACA	60.00 A ... 1000 A	from ±(2.2% of reading + 7 digits) to ±(2.5% of reading + 7 digits)
(DC, 40 Hz ... 400 Hz)		
Hz Line Level Frequency	5.00 Hz ... 999.9 Hz	±(1.0% of reading + 5 digits)
Non-Contact EF-Detection	20 V ... 440 V	Tolerance: 10 V ... 1000 V
Detection Frequency	50/60Hz	
Transient Protection	8.0 kV (1.2/50 μs surge)	
Overload Protections	Current & Hz functions via jaws: 1000 ADC/AAC rms at < 400 Hz Other functions via terminals: 1000 VDC/VAC rms	
Power Supply	2 x 1.5 V batteries, type AAA	
Power Consumption	Typical 13 mA for Current functions	
Dimension (L x W x H)	258 x 94 x 44 mm	
Weight	392 g	
Jaw opening & Conductor diameter	51 mm max	

# Clamp meters

## MD 9226 TRMS AC/DC Current Clamp Meter

The MD 9226 is a professional DC and TRMS AC current clamp meter capable of measuring capacitance and frequency. It is equipped with a built-in VFD feature that makes the instrument capable of measuring the true values in accordance with frequency. The MD 9226 has a wide range of extra features, including peak value, data and MAX hold functions, auto power off, auto-ranging and a relative zero function. It uses state-of-the-art measurement technology and is housed in a sturdy industrial-grade case.



### MEASURING FUNCTIONS

- DC and TRMS AC voltage up to 600 V;
- TRMS AC current measurement up to 600 A;
- Resistance measurement;
- Acoustic continuity test;
- Diode test;
- Frequency measurement;
- Capacitance measurement;
- Temperature measurement.

### KEY FEATURES

- **Auto-ranging.**
- LCD display with **backlight**, 3-5/6 digit, 6000 count.
- **AmpTip™ Low current & Hz:** clamp tip for measuring AC and DC current up to 60 A.
- Automatic, **non-contact detection** of electromagnetic fields to locate and trace live conductors.
- **Data hold** function.
- **MIN/MAX/AVG** function.
- **Peak value.**
- **Relative zero.**
- **35 mm** jaw opening.
- **CAT IV / 300 V**, CAT III / 600 V overvoltage categories.

### APPLICATION

- System maintenance;
- Power system checking;
- High level industrial testing;
- High level electrical testing.

### STANDARD SET

- MD 9226**
- Current clamp MD 9226
  - Test lead, 2 pcs

- Battery, 2 pcs
- Pouch
- Instruction manual
- Warranty

### TECHNICAL DATA

FUNCTION	Range	Accuracy
DC Voltage	600.0 V	±(1.0% of reading + 5 digits)
AC Voltage (50 Hz ... 60 Hz)	600.0 V	±(1.0% of reading + 5 digits)
DC+AC Voltage (DC, 50 Hz ... 60 Hz)	600.0 V	±(1.2% of reading + 7 digits)
PEAK-rms (ACV & ACA)	Response: 80 ms to > 90%	
Audible Continuity Tester	Audible Threshold: At between 10 Ω and 250 Ω. Response time: 32ms approx.	
Ohm	600.0 Ω, 6.000 kΩ, 60.00 kΩ	±(1.0% of reading + 5 digits)
Capacitance	200.0 μF, 2500 μF	±(2.0% of reading + 4 digits)
Diode Tester	2.000 V	±(1.5% of reading + 5 digits)
AmpTip™ clamp-on ACA (50 Hz ... 60 Hz)	60.00 A	±(1.5% of reading + 5 digits)
AmpTip™ clamp-on DCA	60.00 A	±(2.0% of reading + 5 digits)
AmpTip™ clamp-on DC+ACA (DC, 50 Hz ... 60 Hz)	60.00 A	±(2.0% of reading + 7 digits)
Regular Clamp-on ACA (50 Hz ... 400 Hz)	60.00 A ... 600.0 A	from ±(1.8% of reading + 5 digits) to ±(2.0% of reading + 5 digits)
Regular Clamp-on DCA	60.00 A ... 600.0 A	±(2.0% of reading + 5 digits)
Regular Clamp-on DC+ACA (DC, 50 Hz ... 400 Hz)	60.00 A ... 600.0 A	from ±(2.2% of reading + 7 digits) to ±(2.7% of reading + 7 digits)
Hz Line Level Frequency	5.00 Hz ... 999.9 Hz	±(1.0% of reading + 5 digits)
Non-Contact EF-Detection	20 V ... 440 V	Tolerance: 10 V ... 600 V
Detection Frequency	50/60 Hz	
Transient Protection	6.0 kV (1.2/50 μs surge)	
Overload Protections	Current & Hz functions via jaws: 600 A DC / A AC rms at < 400 Hz Other functions via terminals: 600 V DC / V AC rms	
Power Supply	2 x 1.5 V batteries, type AAA	
Power Consumption	13 mA	
Dimension (L x W x H)	223 x 76 x 37 mm	
Weight	234 g	
Jaw opening & Conductor diameter	35 mm	

# Clamp meters

## MD 9210 Mini Clamp Meter



Versatility, sturdy case, high accuracy and lots of measurement functions are key features of the current clamp MD 9210. This universal current clamp offers good value for money.

### MEASURING FUNCTIONS

- AC, DC voltage measurement;
- AC current measurement;
- Frequency measurement;
- Resistance measurement;
- Continuity testing;
- Capacitance measurement;
- Diode test.

### KEY FEATURES

- **Jaw size:** 26 mm.
- **Lightweight:** 139 g only.
- **High specification:** readings up to 600 A with excellent accuracy.
- **Auto-ranging:** no need of manual ranging.
- **Relative zero mode:** relative function for comparing the difference between signals or removing background noise.
- **Data Hold:** data hold feature freezes the display for later view.
- **MAX Hold:** MAX hold feature freezes the maximum measured value.
- **Easy to read:** large bright 3-3/4 digits 4000 counts LCD display.

### APPLICATION

- Working in small enclosures;
- General purpose;
- 3-phase machinery testing.

### TECHNICAL DATA

FUNCTION	Range	Accuracy
DC voltage	400.0 mV	±(0.3 % of reading + 4 digits)
	4.000 V, 40.00 V, 400.0 V	±(0.5 % of reading + 3 digits)
	600 V	±(1.0 % of reading + 4 digits)
AC voltage (50 Hz ... 500 Hz)	4.000 V, 40.00 V, 400.0 V	±(1.5 % of reading + 5 digits)
	600 V	±(2.0 % of reading + 5 digits)
AC current (50 / 60 Hz)	40.00 A, 400.0 A, 600 A	±(1.5 % of reading + 8 digits)
Resistance	400.0 Ω	±(0.8 % of reading + 8 digits)
	4.000 kΩ, 40.00 kΩ, 400.0 kΩ	±(0.6 % of reading + 4 digits)
	4.000 MΩ	±(1.0 % of reading + 4 digits)
	40.00 MΩ	±(2.0 % of reading + 4 digits)
Diode test	Open-circuit voltage <1.6 VDC, test current 0.25 mA	
Frequency	10 Hz ... 100 kHz	±(0.5 % of reading + 4 digits)
Capacitance	500.0 nF ... 3000 μF	±(3.5 % of reading + 6 digits)
Power supply	3 V battery (IEC-CR2032)	
Overvoltage category	CAT IV / 300 V; CAT III / 600 V	
Dimensions	190 x 63 x 32 mm	
Weight	139 g	



### STANDARD SET

- **MD 9210**
- Current clamp MD 9210
- Test lead with probe, 2 pcs
- 3 V battery
- Pouch
- Instruction manual
- Warranty



# Voltage and continuity testers

## Selection Guide for Voltage and Continuity Testers

FEATURES	Description	MD 1160 LCD Voltage / Continuity Tester	MD 1060 LED Voltage / Continuity Tester
			
<b>AC VOLTAGE</b>	Test Range	12 V ... 690 V	12 V ... 690 V
	Response Time	<1s	<1s
	Frequency Range	16 ... 400 Hz	16 ... 400 Hz
<b>DC VOLTAGE</b>	Test Range	12 V ... 690 V	12 V ... 690 V
	Response Time	<1s	<1s
<b>RESISTANCE &amp; CONTINUITY TEST</b>	Indication	Acoustical and LED indication	Acoustical and LED indication
	Continuity test (Acoustic)	0 ... 500 kΩ +50%	0 ... 500 kΩ +50%
	Test current	3.5 mA	3.5 mA
<b>PHASE TESTING</b>	Phase Testing	Single-Pole Phase testing	Single-Pole Phase testing
	Phase Sequence	Two-Pole Phase Sequence testing	Two-Pole Phase Sequence testing
	Phase indication	>100 V AC	>100 V AC
<b>DISPLAY</b>	Type	LC display	LED display
	Tolerance	0 V ... 690 V ± (3% ± 5dgt)	12 V, 24 V, 50 V, 120 V, 230 V, 400 V, 690 V
	Torch lamp	LED	LED
<b>GENERAL</b>	Overload Category	CAT IV 600 V	CAT IV 600 V
	Compliant to standards	IEC/EN 61243-3:2014, DIN VDE 0411, IEC 61010, GS38	IEC/EN 61243-3:2014, DIN VDE 0411, IEC 61010, GS38
	Protection degree	IP64 For outdoor use: Water jet and dust tight protection	IP64 For outdoor use: Water jet and dust tight protection
	Temperature range	-15 ... 55 °C	-15 ... 55 °C
	Battery type	2 x 1,5 V Type AAA Micro	2 x 1,5 V Type AAA Micro
	Dimensions	240 x 60 x 20 mm	240 x 60 x 20 mm
	Weight	200 g	200 g



# Voltage and continuity testers

## MD 1160 LCD Voltage / Continuity Tester

A two-pole voltage detector is a basic tool kit for electricians. High quality rubber construction make this the professional's choice. Both models support Voltage measurement, Continuity measurement, Single pole test, Phase rotating field test and a torch function via a white LED for working in dark areas. The products are built in accordance to the latest voltage tester standard IEC/EN 61243-3:2014 and are GS approved by TÜV test lab.



### MEASURING FUNCTIONS

- AC, DC voltage testing;
- Phase testing;
- Rotary field testing;
- Continuity testing.

### KEY FEATURES

- Voltage testing up to 690 V;
- Automatic AC/DC recognition;
- Continuity buzzer and led to indicate resistances below 500 k $\Omega$ ;
- Phase & Rotating Field Test;
- Auto Power Off;
- LCD display (MD 1160);
- Optical and Acoustic indication of Protective Extra Low Voltage.

### APPLICATION

- Mid-level electrical testing;
- Mid-level electronic fault finding;
- Field servicing;
- General purpose.

### STANDARD SET

#### MD 1160

- Voltage tester MD 1160
- 1.5 V battery, type AAA, 2 pcs
- Plastic probe guard (in accordance with GS38)
- Instruction manual
- Warranty

### TECHNICAL DATA

FUNCTION	Range
Nominal voltage range	12 V ... 690 V AC TRMS (automatic range selection)
Nominal voltage range	12 V ... 690 V DC (automatic range selection)
Frequency range	16 ... 400 Hz
Continuity test (Acoustic)	0 ... 500 k $\Omega$
RCD test current	3.5 mA
Phase indication	>100 VAC
Phase rotation determination	2-pole
Reaction time	< 0.1 s
Display	LC display
Power supply	2 x 1.5 V batteries, type AAA
Overvoltage category	CAT IV / 600 V
Dimensions	240 x 60 x 20 mm
Weight	200 g

# Voltage and continuity testers

## MD 1060 LED Voltage / Continuity Tester



A two-pole voltage detector is a basic tool kit for electricians. High quality rubber construction make this the professional's choice. Both models support Voltage measurement, Continuity measurement, Single pole test, Phase rotating field test and a torch function via a white LED for working in dark areas. The products are built in accordance to the latest voltage tester standard IEC/EN 61243-3:2014 and are GS approved by TÜV test lab.

### MEASURING FUNCTIONS

- AC, DC voltage testing;
- Phase testing;
- Rotary field testing;
- Continuity testing.

### KEY FEATURES

- Voltage testing up to 690 V;
- Automatic AC/DC recognition;
- Continuity buzzer and led to indicate resistances below 500 kΩ;
- Phase & Rotating Field Test;
- Auto Power Off;
- LED display (MD 1060);
- Optical and Acoustic indication of Protective Extra Low Voltage.

### APPLICATION

- Mid-level electrical testing;
- Mid-level electronic fault finding;
- Field servicing;
- General purpose.

### STANDARD SET

#### MD 1060



- Voltage tester MD 1060
- 1.5 V battery, type AAA, 2 pcs
- Plastic probe guard (in accordance with GS38)
- Instruction manual
- Warranty

### TECHNICAL DATA

FUNCTION	Range
Nominal voltage range	12 V ... 690 V AC TRMS (automatic range selection)
Nominal voltage range	12 V ... 690 V DC (automatic range selection)
Frequency range	16 ... 400 Hz
Continuity test (Acoustic)	0 ... 500 kΩ
RCD test current	3.5 mA
Phase indication	>100 VAC
Phase rotation determination	2-pole
Reaction time	< 0.1 s
Display	LED bargraph
Power supply	2 x 1.5 V batteries, type AAA
Overvoltage category	CAT IV / 600 V
Dimensions	240 x 60 x 20 mm
Weight	200 g

# Non contact voltage detectors

## Selection Guide for Non Contact Voltage Detector

FEATURES	Description	MD 126 Non-contact voltage and phase rotation detector	MD 116 Non Contact Voltage Detector	MD 106 Non Contact Voltage Detector
				
<b>MEASUREMENTS</b>	Measurement range	100 ... 1000 V AC	12 ... 1000 V AC	90 ... 1000 V AC
	Frequency Range	45 ... 60 Hz	40 ... 400 Hz	50 ... 60 Hz
	Phase sequence	•		
<b>DISPLAY</b>	Optical	•	•	•
	Acoustical	•	•	•
	Vibrating		•	
<b>GENERAL</b>	Overvoltage category	CAT IV / 1000 V	CAT IV / 1000 V	CAT IV / 1000 V
	Degree of protection	IP67	IP65	IP65
	Battery type	2 x 1,5 V LR03 batteries (type AAA)	2 x 1,5 V LR03 batteries (type AAA)	2 x 1,5 V LR03 batteries (type AAA)
	Dimensions	162 x 24 x 29 mm	155 x 25 x 23 mm	155 x 25 x 23 mm
	Weight	69 g	58 g	58 g



# Non contact voltage detectors

## MD 126 Non-contact voltage and phase rotation detector

Voltage detection is the most basic safety test. The MD 126 offers a non-contact detection using coloured LED lights as indication. In a three phase system, the coloured lights indicate the phase sequence. A practical flashlight completes the functionality. The housing is small and light with the IP67 protection against water and dust, and 3 m drop test for robustness.



NEW

Non contact voltage detectors

### MEASURING FUNCTIONS

- Voltage detection;
- Phase sequence detection.

### KEY FEATURES

- Measures both voltage presence and phase sequence;
- Wide measuring range 100 V ... 1000 V;
- Robust housing with IP67 and 3 m drop test;
- Flashlight;
- Sound and coloured light indication.

### APPLICATION

- Basic electrical safety;
- Low-level electrical testing.

### STANDARD SET

#### MD 126

- MD 126 Non-contact voltage and phase rotation detector
- 2 AAA 1.5V batteries
- Instruction manual
- Warranty

### TECHNICAL DATA

FUNCTION	Range
Detection voltage range	100 V ... 1000 V
Phase sequence range	200 V ... 1000 V
Frequency range	50/60 Hz
Batteries	2 AAA, 1.5 V
Operating temperature	0 ... 50 °C
Operating humidity	80 % max
Storage temperature	-10 °C ... 60 °C
Altitude limit	2000 m
Pollution degree	2
Safety	CAT IV / 1000 V
Dimensions	162 x 24 x 29 mm
Weight	Approx. 69 g

# Non contact voltage detectors

## MD 116 Non Contact Voltage Detector



The MD 116 is a non-contact voltage tester that features an optical, acoustical and a vibrating indicator. It comes complete with a pocket clip. It is easy to operate and is an essential tool for both home handymen and professionals. The MD 116 can detect live-voltage wires in splices, cable plugs, cable drums, sockets, switches and junction boxes. The operation of the MD 116 is self-tested automatically after power up. No extra button required. It supports switching between low and high sensitivity (12 / 90 V AC) and has an integrated LED flashlight for working in dark conditions. The Metrel MD 116 uses a capacitive measuring process. In contrast to inductive measurements, no flow of current is required.

### MEASURING FUNCTIONS

- Non-contact voltage detection from 12 V AC;
- High performance LED flashlight;
- Optical, acoustical and vibrating indication in case of power.

### KEY FEATURES

- 12 V ... 1000 V AC measurement range.
- Optical, acoustical and vibrating indication.
- CAT IV / 1000 V overvoltage protection.

### APPLICATION

- General purpose.
- Low level electrical testing.
- Hobby work.

### STANDARD SET

#### MD 116

- Non-contact voltage detector MD 116
- 1.5 V battery test, type AAA, 2 pcs
- Instruction manual
- Warranty

### TECHNICAL DATA

FUNCTION	Range
Display	Optical, acoustical, vibrating
Overvoltage category	CAT IV / 1000 V
Measurement range	12 ... 1000 V AC
Frequency range	40 ... 400 Hz
Temperature range	0 ... 40°C, < 80% relative humidity
Current consumption	80 mA
Duty cycle	Continuous
Power supply	2 x 1,5 V LR03 batteries (type AAA)
Degree of protection	IP 65
Dimensions	155 x 25 x 23 mm
Weight	Approx. 58 g

# Non contact voltage detectors

## MD 106 Non Contact Voltage Detector

The MD 106 is a basic non-contact voltage tester that features an optical and acoustical indicator. It comes complete with a pocket clip. It is easy to operate and is an essential tool for both home handymen and professionals. The MD 106 can detect live-voltage wires in splices, cable plugs, cable drums, sockets, switches and junction boxes. The operation of the MD 106 can be verified with the self-test button. The Metrel MD 106 uses a capacitive measuring process. In contrast to inductive measurements, no flow of current is required.



### MEASURING FUNCTIONS

- Non-contact voltage detection from 90 V AC.
- Optical and acoustical indication in case of power.

### KEY FEATURES

- 90 V ... 1000 V AC measurement range.
- Optical and acoustical indication.
- CAT IV / 1000 V overvoltage protection.

### APPLICATION

- General purpose.
- Low level electrical testing.
- Hobby work.

### STANDARD SET

#### MD 106



- Non-contact voltage detector MD 106
- 1.5 V battery test, type AAA, 2 pcs
- Instruction manual
- Warranty

### TECHNICAL DATA

FUNCTION	Range
Display	Optical, acoustical
Overvoltage category	CAT IV / 1000 V
Measurement range	90 ... 1000 V AC
Frequency range	50 ... 60 Hz
Temperature range	-10°C ... +50°C, < 75% relative humidity
Current consumption	80 mA
Duty cycle	Continuous
Power supply	2 x 1,5 V LR03 batteries (type AAA)
Degree of protection	IP 65
Dimensions	155 x 25 x 23 mm
Weight	Approx. 56 g

# Thermal cameras

## Selection Guide for Thermal cameras

FEATURES	Description	MD 9930 Thermal camera	MD 9910 Thermal camera	MD 9880 TRMS thermal multimeter
				
<b>FEATURES</b>	IR sensor resolution	160 x 120 pxl	80 x 80 pxl	80 x 81 pxl
	Temperature range	-20 ... 350°C	-20 ... 380 °C	-20 ... 260°C
	Thermal sensitivity/NETD	0.1°C @ 30°C / 100 mK	0.1°C @ 30°C / 100 mK	0.1°C @ 30°C / 100 mK
	Thermal accuracy	±2°C or ±2 %	±2°C or ±2 %	±3°C or ±3.0 %
	Field of vision	25° x 19°	21° x 21°	21° x 21°
	Spectral range	8 ... 14 μm	8 ... 14 μm	8 ... 14 μm
	Emmissivity range	0.01 ... 1.0	0.01 ... 1.0	0.01 ... 1.0
	Frame rate	50 Hz	50 Hz	50 HZ
	Focal length	9 mm	7.5 mm	7.5 mm
	Spatial resolution	2.78 mrad	4.53 mrad	4.53 mrad
	Level and span	Auto and manual	Auto	Auto
	Min focused distance	0.5m	0.5m	0.5m
	Focus	Manual	Fixed	Fixed
	Visible light camera	•		
	Fusion view	•		
	Display resolution	240 x 320 pxl	240 x 320 pxl	240 x 320 pxl
	Thermal video	•		
<b>GENERAL</b>	Data storage	Internal 100 MB + SD card up to 32 GB	Internal 20 images	
	Battery	Li-Ion, up to 4h	Li-Ion, up to 6h	Li-Ion, up to 6h
	Multimeter			•



# Thermal cameras

## MD 9930 Thermal camera

MD 9930 is the go-to imager for most applications. Extremely versatile, with a great thermal resolution, it can view and check nearly any thermally stressed object. From electrical distribution boards, motors, bearings and friction, to hidden fault finding in the water supply or electrical systems in buildings. It can shoot both thermal, visible light and combined images that help with orientating and locating the fault from the image. Thermal focus is can be set manually and there is 32x digital zoom available. Cursors and central thermometer make images easy to read while thermal videos with high frame rate can follow quick changes in temperature. Audio comments can be added to the videos.



### MEASURING FUNCTIONS

- Temperature;
- Temperature difference.

### KEY FEATURES

- Very fast frame rate 50 hz;
- Automatic markers on screen;
- 4 different palletes;
- Lock and compare feature;
- Temperature in °C, °F or K;
- Laser pointer;
- LED flashlight;
- Thermal and visible light videos;
- Simultaneous storage of visible light and IR images for video;
- Live transmission of video over HDMI or USB;
- Included 8 GB micro SD card;
- Included card reader for PC;
- PC software for image editing and report building included;
- Li-Ion batteries with long life;
- Internal memory and optional SD card;
- Hold image feature.

### APPLICATION

- Troubleshooting electrical installations and equipment;
- Solar farm inspection;
- Building and facility maintenance;
- Field service;
- Energy loss analysis;
- Troubleshooting other installations.

### STANDARD SET

#### MD 9930

- MD 9930 Thermal camera
- USB cable
- USB OTG cable
- MicroSD card

- Li-ion battery
- AC adapter
- Non-slip strap
- Carrying case
- Instruction manual
- Download link for PC software

### TECHNICAL DATA

FUNCTION	
IR sensor resolution	160 x 120 pxl
Temperature range	-20 ... 350°C
Thermal sensitivity/NETD	0,1°C @ 30°C / 100 mK
Thermal accuracy	Higher value ±2°C or ±2 %
Field of vision	25° x 19°
Spectral range	8 ... 14 µm
Emmissivity	0.01 ... 1.0
Frame rate	50 Hz
Focal length	9 mm
Spatial resolution	2,78 mrad
Min focused distance	0.5 m
Focus	Manual
Visible light camera resolution	5 Mpxl
Visible light lens FOV	59°
Fusion view	yes
Color palletes	4
Display resolution	240 x 320 pxl
Video format	MPEG-4, 1280 x 960 @ 30fps
Image format	JPEG, measurement data included
Data storage	100 MB internal + SD card
Data communication	USB, HDMI
IP protection	IP 40
Operation temperature range	-15°C ... 50°C
Storage temperature range	-40°C ... 70°C
Humidity (operation and storage)	10% ... 90%
Drop test	2 m
Weight	500 g
Dimensions	224 x 77 x 96 mm

# Thermal cameras

## MD 9910 Thermal camera



MD 9910 is a small thermal imager with large ambitions. Frame rate is extremely fast at 50 Hz. 80x80 pixel thermal resolution can show damage on contacts in electrical switchboards or distribution boards, stressed overcurrent or overvoltage protection, or unnecessary friction on motor axle. PCB troubleshooting is made easier by discovering hot spots at close range. At the same time, short focal length allows to go through large areas quickly. Center shot temperature, hot and cold markers give a better sense to the image and its span. Shot images can be immediately transferred to Android device using the app and Bluetooth connection. Span can be set manually to be able to take advantage of its great thermal resolution. Large Li-ion battery allows for 4 to 5h work. It was drop-tested to 2m.

### MEASURING FUNCTIONS

- Temperature;
- Temperature difference.

### KEY FEATURES

- Very fast frame rate 50 hz;
- Three markers on screen (hottest, coldest, central);
- 5 different palletes;
- Lock and compare feature;
- Temperature in °C, °F or K;
- LED flashlight;
- Android apps for Bluetooth connection;
- Instant share of image over Bluetooth;
- Shooting images from Android app;
- Rechargeable Li-Ion batteries with long life;
- Internal memory;
- Hold image feature.

### APPLICATION

- Troubleshooting electrical installations (switchboards, contacts, busbars, etc.);
- Troubleshooting electrical equipment (motors, transformers, etc.);

- Building and facility maintenance;
- Field service;
- Energy loss analysis;
- Troubleshooting in other applications (pipes, carpentry, windows, etc).

### STANDARD SET

- MD 9910**
- MD 9910 Thermal camera
  - USB cable
  - Non-slip strap
  - Carrying case
  - Instruction manual

### TECHNICAL DATA

FUNCTION	
IR sensor resolution	80 x 80 pixel
Temperature range	-20 ... 380°C
Thermal sensitivity/NETD	0,1°C @ 30°C / 100 mK
Thermal accuracy	Higher value ±2°C or ±2 %
Field of vision	21 x 21°
Spectral range	8 ... 14 µm
Emmissivity	0.01 ... 1.0
Frame rate	50 Hz
Focal length	7,5 mm
Spatial resolution	4,53 mrad
Min focus distance	0.5 m
Focus	Fixed
Display resolution	240 x 320 pxl
Color palettes	5
Data storage	100 images
Data communication	Bluetooth
Storage image format	Bmp with temperature and emissivity
IP protection	IP 54
Operating temperature	-10°C - 45°C
Storage temperature	-30°C - 55°C
Humidity (storage and operation)	< 80%
Weight	260 g
Dimensions	180 x 60 x 75 mm

# Thermal cameras

## MD 9880 TRMS thermal multimeter

MD 9880 is the ultimate troubleshooting tool. Combining essential multimeter functions with thermal viewer, it allows a service provider to quickly locate a wide array of possible faults. Hot spots can be then simply tested with electrical measurement. Thermal view also expands the usefulness of the instrument to other applications in the facility or vehicle, locating leaks, frictions stress and thermal losses.



### MEASURING FUNCTIONS

- Temperature with cursor on camera;
- TRMS DC and AC voltage;
- TRMS DC and AC current;
- Resistance;
- Frequency;
- Capacitance;
- Duty cycle;
- Diode test.

### KEY FEATURES

- Thermal view;
- Automatic and manual range;
- Hold and auto-hold modes;
- MIN/MAX values capture;
- Relative mode;
- Peak capture mode;
- Temperature in °C, °F or K.

### APPLICATION

- Troubleshooting electrical installations (switchboards, contacts, busbars, etc.);
- Troubleshooting electrical equipment;
- Troubleshooting electrical vehicles;
- Mid-level electrical testing;
- Field service;
- Building and facility maintenance;
- Energy loss analysis;
- Troubleshooting other installations (pipes, carpentry, windows, etc);
- Hobby work.

### STANDARD SET

- **MD 9880**
- MD 9880 TRMS thermal multimeter
- USB cable

- Carrying case
- Measuring probes
- Instruction manual

### TECHNICAL DATA - THERMAL VIEWER













FUNCTION	
IR sensor resolution	80x80 pxl
Temperature range	-20 – 260°C
Thermal sensitivity/NETD	0,1°C @ 30°C / 100 mK
Thermal accuracy	Higher value ±3°C or ±3 %
Field of vision	21° x 21°
Spectral range	8 – 14 µm
Frame rate	50 Hz
Focal length	7.5 mm
Spatial resolution	4.53 mrad
Emissivity	0.01 – 0.99
Min focus distance	0.5m
Focus	Fixed
Colour palettes	4
IP protection	40

### TECHNICAL DATA - THERMAL VIEWER - MULTIMETER





FUNCTION	Ranges	Accuracy
DC voltage	400.0 mV ... 600.0 V	From ±(0.5 % + 5d) to ±(0.8 % + 8d)
AC TRMS voltage	4.000 V ... 600.0 V	From ±(1.0 % + 5d) to ±(2.5 % + 5d)
AC + DC TRMS voltage	4.000 V ... 600.0 V	±(2.5 % + 5d)
DC current	400.0 µA ... 10.00 A	From ±(1.5 % + 5d) to ±(2.0 % + 8d)
AC TRMS current	400.0 µA ... 10.00 A	From ±(2.0 % + 5d) to ±(2.5 % + 8d)
Resistance/continuity	400.0 Ω ... 40.00 MΩ	From ±(1.0 % + 5d) to ±(2.5 % + 10d)
Frequency	40.00 Hz ... 10.00 MHz	From ±(0.2 % + 5d) to ±(0.5 % + 0d)
Capacitance	40.00 nF ... 4000 µF	From ±(3.0 % + 8d) to ±(3.5 % + 20d)
Duty cycle	10.0 % ... 90.0 %	±(1.2 % + 2d)
Diode test	Test current <1.5 mA. max open circuit voltage 3.3 V	



# Selection Guide for DMM Accessories

Photo	Part number	Description	Target application	MD 9070	MD 9060	MD 9050	MD 9040	MD 9030	MD 9020	MD 9016	MD 9273	MD 9272	MD 9260	MD 9250	MD 9240	MD 9235	MD 9231	MD 9226	MD 9225	MD 9210	MD 1060	MD 1160	MD 9930
	AMD 9027	Remote probe	Probe with switch for starting insulation or continuity test.	•																			
	AMD 9028	Alligator clip	Insulated test lead accessory for gripping the measured item.	•	•	•	•	•	•	•	•	•	•	•	•	•	•	•	•	•	•	•	•
	AMD 9026	Test lead with probe, 2 pcs	Test lead with probe, 2 pcs.	•	•	•	•	•	•	•	•	•	•	•	•	•	•	•	•	•	•	•	•
	S 2025	Test lead, 1.5 m, 2 pcs (black, red)	Connection leads for different measurements.								•												
	A 1013	Crocodile clip, black	Crocodile clip assures secure and permanent contact during the measurement on bus bars, fixing screws, etc.								•												
	A 1064	Crocodile clip, red	Crocodile clip assures secure and permanent contact during the measurement on bus bars, fixing screws, etc.								•												
	A 1778	Magnetic contact probe	The A 1778 magnetic probe (with a Ø6.6 mm right-angle magnetic adapter and a Ø4 mm socket) is designed for semi-temporary measurement of voltage on steel screw terminal blocks.								•												
	AMD 1190	Probe caps and metal pins	Probe caps and metal pins.																		•	•	
	AMD 9023	Thermocouple probe, type K	Probe for contact temperature measurement.	•	•			•	•	•			•	•	•					•			
	AMD 9024	Adapter for thermocouple probe AMD 9023	Adapter is intended to connect the thermocouple probe with a multimeter.	•	•			•	•	•			•	•	•					•			
	AMD 9025	PC Software for MD 9016 with RS232 cable	Basic downloading software supplied on CD and RS232 communication cable.								•												
	AMD 9050	USB interface set	Communication set contains USB adapter, USB and RS232 drivers and PC software on CD.	•	•	•																	

• Option

Photo	Part number	Description	Target application	MD 9070	MD 9060	MD 9050	MD 9040	MD 9030	MD 9020	MD 9016	MD 9273	MD 9272	MD 9260	MD 9250	MD 9240	MD 9235	MD 9231	MD 9226	MD 9225	MD 9210	MD 1060	MD 1160	MD 9930
	AMD 9240	PC interface set for MD 9240	PC interface set enables data transferring to the PC. Set contains optical adapter, cable and PC software on CD.												•								
	AMD 9250	PC interface set for MD 9250													•								
	AMD 9022	Magnetic Hanging Strap	The universal hanger allows you to hang your meter on metal surfaces.	•	•		•			•													
	AMD 9030	Spare Li-ion Battery	Spare Li-ion Battery for MD 9930																				•
	AMD 9100	Soft carrying pouch	Soft carrying pouch for digital multimeter storage. Dimensions: 220 x 125 x 70 mm.	•	•	•	•																

• Option

# Content

## Software

Electrical Installation Safety	1.1 - 1.72
High Voltage Insulation / Continuity / Earth / Transformer	2.1 - 2.48
Appliance / Machine / Switchboard Safety	3.1 - 3.52
Power Quality Analysis	4.1 - 4.26
Equipment for laboratories and Schools	5.1 - 5.16
Multimeters / Clamp meters / Voltage testers / Thermal cameras	6.1 - 6.44
<b>SOFTWARE</b>	<b>7.1 - 7.19</b>

### **SOFTWARE**

Selection Guide for Software	7.02
------------------------------	------

### **PC SOFTWARE**









SW 1201 Metrel Electrical Safety Manager (MESM)	7.04
SW 1402 Metrel Medical Electrical Safety Manager (MMESM) <b>NEW</b>	7.05
SW 1203 Metrel SDK	7.06
SW 1403 Black Box protocol	7.08
SW 0802 PowerView3	7.10
SW 0201 PATLink PRO	7.12
SW 0101 EuroLink PRO	7.13
SW 0113 HVLink PRO	7.14

### **ANDROID**

SW 1304 aMESM Android	7.15
SW 1303 aPAT Android	7.16
SW 1306 EuroLinkPV Android	7.17
SW 1308 PATLink Android	7.18
SW 1307 EuroLink Android	7.19

# Software

## Selection Guide for Software

GROUP	Instrument/Software	SW 1201 MESM	SW 1203 Metrel SDK**	SW 1402 MMESM NEW	SW 0802 Power View3	SW 0201 PATLink PRO	SW 0101 EuroLink PRO	SW 0113 HVLINK PRO
								
LICENCE		P 1101 (Licence)	P 1104 (Licence)			A 1203 (Licence)	A 1292 (Licence)	A 1275 (Licence)
ELECTRICAL INSTALLATION SAFETY	MI 3155 EurotestXD	•	•					
	MI 3152 EurotestXC	•	•					
	MI 3152H EurotestXC 2,5 kV	•	•					
	MI 3102 BT EurotestXE	•	•***				•	
	MI 3102H BT EurotestXE 2,5 kV	•	•***				•	
	MI 3102H SE EurotestXE 2,5 kV	•	•***					
	MI 3100 SE EurotestEASI	•	•***				•	
	MI 3125 BT EurotestCOMBO	•	•***				•	
	MI 3108 EurotestPV	•					•	
	MI 3109 EurotestPV Lite	•					•	
	MI 3144 Euro Z 800 V	•	•					
	MI 3143 Euro Z 440 V	•	•					
	MI 3121 Insulation / Continuity						•	
	MI 3121H Insulation / Continuity						•	
MI 3122 Z Line-Loop / RCD						•		
MI 3123 Earth / Clamp						•		
APPLIANCE / MACHINE / SWITCHBOARD SAFETY	MI 3325 MultiServicerXD	•	•					
	MI 3394 CE MultiTesterXA	•	•					
	MI 3394 CE MultiTesterXS	•	•					
	MI 3360 OmegaPAT XA	•	•					
	MI 3309 BT DeltaGT	•	•***			•		
	MI 3311 GammaGT					•		
	MI 6601 MediTest <b>NEW</b>		•	•				
POWER QUALITY ANALYSIS	MI 2893 Power Master XT				•			
	MI 2892 Power Master				•			
	MI 2885 Master Q4				•			
	MI 2884 Energy Master XA				•			
	MI 2883 Energy Master				•			
HIGH VOLTAGE INSULATION / CONTINUITY / EARTH / TRANSFORMER	MI 3252 MicroOhm 100A							•
	MI 3210 TeraOhmXA 10 kV							•
	MI 3209 TeraOhmLT 10 kV							•
	MI 3201 TeraOhm 5 kV Plus							•
	MI 3290 Earth Analyser	•	•					
	MI 3288 Earth Insulation Tester	•	•					
	MI 3280 DT Analyser	•	•					
	MI 3281 WR Analyser <b>NEW</b>	•	•					
	MI 3295 Step Contact Voltage Measuring System	•	•***					•
DIGITAL MULTIMETERS / CLAMP METERS	MD 9060 Digital multimeter							
	MD 9050 Digital multimeter							
	MD 9040 Digital multimeter							
	MD 9016 Digital multimeter							
	MD 9250 Current clamp							
	MD 9240 Current clamp							
	MD 9930 Thermal camera							
	MD 9910 Thermal camera							





# Software

## SW 1201 Metrel Electrical Safety Manager (MESM)

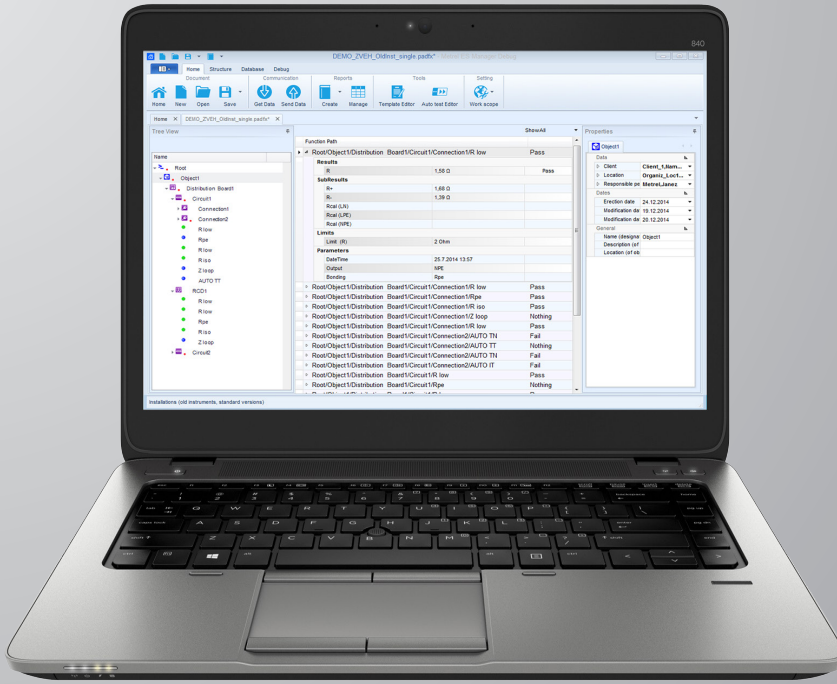

The Metrel Electrical Safety Manager is a common application for management of wide palette of Metrel's electrical safety testers, portable appliance testers, machine testers and industrial safety testers. This application has a unified user interface with the new generation of Metrel's instruments - same view same meaning. It enables the pre-treatment for the measurements, viewing and editing of the measurement results and generation of professional reports. Depending on the instrument model or type, the user can create AUTOSEQUENCES, custom tests or single tests. They can be integrated into the custom created test structures and then uploaded onto the measurement instrument.

The downloaded measurement results can be viewed, analysed, edited and finally a professional report can be created and printed. These professional reports are predefined templates according to national standards and regulatory organisations where the user enters all the needed protocol data while the measurement results are automatically inserted into the predefined forms. This application is fully compatible with the new generation of Metrel's multifunction testers, starting with CE MultitesterXA and EurotestXC. With limited functionality some of the predecessor models like EurotestXE or EurotestCombo are also supported.

### KEY FEATURES

- **Common platform for a wide range of Metrel's instruments:** a Windows based application for most of the future Metrel's instruments.
- **Multilevel test structure editor:** the installation structure can be created in advance on the PC and then simply uploaded to your tester.
- **Measurement editor:** enables definition of tests within the test structure with

all parameters and sub parameters. After the structure is uploaded to the instrument, such predefined tests can be selected and started without additional settings.

- **AUTO SEQUENCES editor:** application for easy and efficient preparation of AUTO SEQUENCES or custom tests.
- **Report creator:** enables automatic generation of professional test reports which include visual inspections of tested objects and test results in tabular form.
- **Multilingual reports according to local regulations:** different languages for the application and reporting are supported.
- **Export of test results:** test results in text (.csv) or .xml format can be exported to other programs.

### The BASIC Licence allows the user to:

- Upload structures with empty or already performed measurements to the measuring device.
- Upload and download Auto Sequences (not supported by MI 3152).
- Download structures prepared with the measuring device (e.g. MI 3152) to MESM.

- Download measured data to MESM.
- Print results and create a basic report.
- Upgrade FW on the device.
- Synchronize Licences between the measuring device and the PC.

### The PRO Licence allows the user to:

- Perform all operations as described above for BASIC Licence.
- Print professional reports.
- PRO export to Excel.

\* Fully featured export to Excel  
\* Integrated SDK and Black-box protocol.

### COMPATIBILITY

- Consult the Selection Guide for Software on page 7.2 for detailed information about compatibility with selected test and measurement instruments.

# Software

## SW 1402 Metrel Medical Electrical Safety Manager (MMESM)

Metrel Medical Electrical Safety Manager is an application for the management of testing results and report creation for medical devices. It is supported by Metrel MI 6601 Meditest. Metrel Medical Electrical Safety Manager is an intuitive application that keeps the tested devices in a transparent tree structure. Their testing results can be viewed, searched for, and filtered in the middle of the screen, while additional data and properties are kept in the table on the right. Remote tests on MI 6601 can be started from the tree structure or from the ribbon.

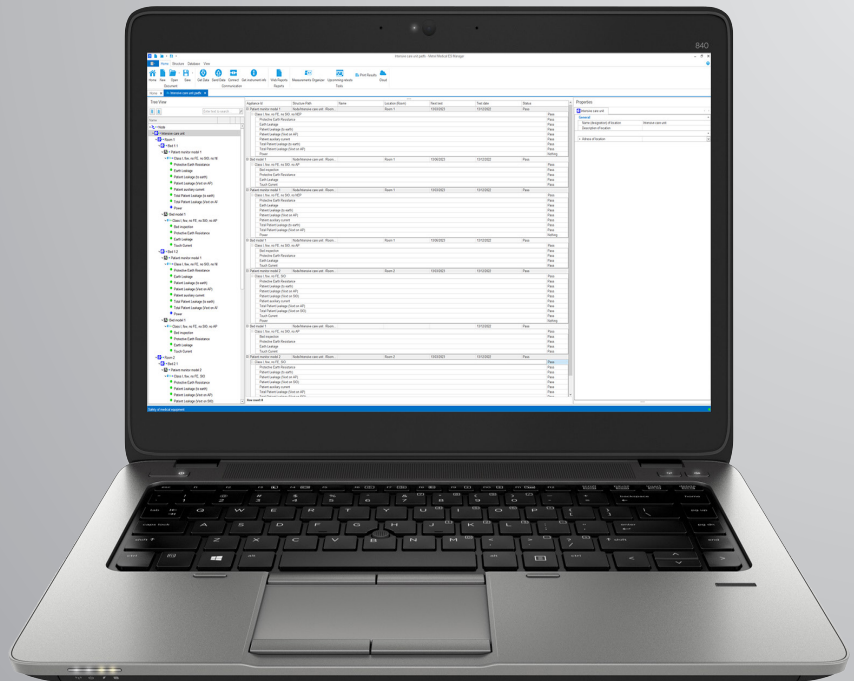

A new component, Measurement Organiser, enables programming the connections between the DUT and the test instrument and also serves for preparing and saving Auto Sequences. A powerful test scheduler keeps track of future tests. Professional reports are created online using the Metrel Cloud Reports service.

### KEY FEATURES

- **Multilevel test structure editor:** the installation structure can be created in advance on the PC.
- **Measurement editor:** add measurements with all parameters to the test structure. Remote start the testing from the test structure.

- **Measurements organiser:** advanced application for easy and efficient preparation of AUTO SEQUENCES and custom tests together with programming the connections to the DUT.
- **Integrated with Metrel Cloud** for access to files from any location.
- **Simple report creator:** generates the basic printout of tested devices with test statuses.
- **Professional reports creation:** highly customizable professional reports based on Word templates.  
**Export of test results:** test results in text (.csv) or .xml format can be exported to other programs.

### COMPATIBILITY

- Consult the Selection Guide for Software on page 7.2 for detailed information about compatibility with selected test and measurement instruments.

# Software

## SW 1203 Metrel SDK



Metrel SDK is a Software Development Kit prepared for clients who want to exchange and manipulate data measured with Metrel instrument in non MESM (Metrel ES Manager) environment, where clients use their own applications or/and services.

Client can obtain MESM functionalities in his own applications or/and services by implementing Metrel SDK.

The Metrel SDK itself is a set of subroutine definitions, protocols, and tools for building application software. It is intended for those who want to develop software using .NET platform and need to interface with Metrel instruments. The Metrel SDK bundles client libraries for accessing Metrel instruments and provides a unified programming interface using C# programming language.

Metrel SDK includes a set of API calls which makes communication with Metrel instruments simple for the user. It provides a way to manipulate data from instruments using a generic data model and makes available a set of rules for extracting and viewing data.

Metrel SDK is a .NET based SDK. Needed prerequisites for Metrel SDK implementation would be as follows:

- .NET or .NET Core development environment (Visual Studio, Visual Studio Code, JetBrains Rider...),
- Good knowledge of C# programming language.

### METREL INSTRUMENTS

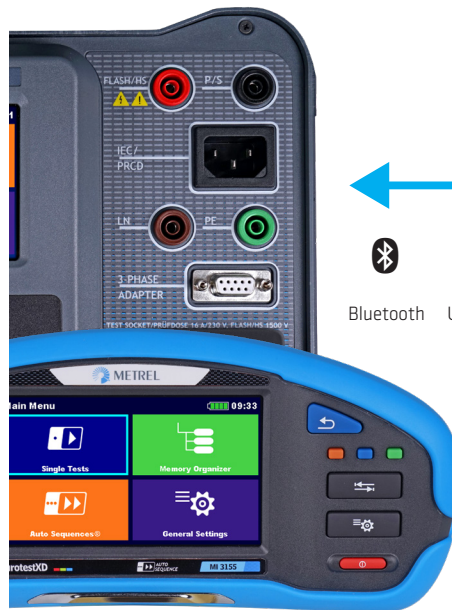

Metrel SDK in interaction with Metrel instruments.

### SOFTWARE WITH IMPLEMENTED METREL SDK

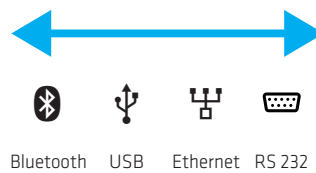
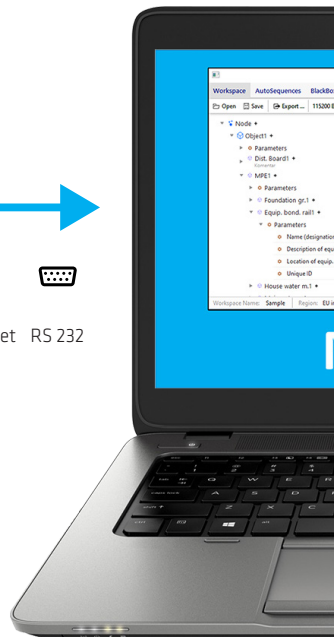

## SUPPORTED FUNCTIONALITIES OF METREL SDK

- Displays instrument information.
- Performs instrument Firmware update check.
- Lists workspaces in file or instrument.
- Creates empty measurements.
- Creates structure objects.
- Downloads Workspace or Auto Sequence® from instrument.
- Downloads measurements from instrument.
- Uploads Workspace or Auto Sequence® to instrument.
- Uploads measurements to instrument.
- Uploads license key to instrument.
- Exports Workspace data to selected target.
- Exports XML schemas from XML validation.
- Supports CLI (Command Line Interface):
  - Exports to XML and JSON format (Flat and tree structure).
- Supports Black-Box protocol for remote / online communication.
- Supports all available communication with Metrel instruments: Ethernet, RS232, USB and Bluetooth.

## METREL SDK PACKAGE

Metrel SDK is included in Metrel SDK zip package which is available from Metrel free of charge. Metrel SDK alone is a set of libraries located in »libs« folder. Content of Metrel SDK zip package is described in table below.

Metrel SDK zip package	
Folder name	Folder content
apps	cli folder Contents command line interface application. Run "ion.exe" in Command Prompt to start application.
demo	ddVisualizer folder Contents DataDisplay Framework Visualizer, which graphically describes basic entities and relations between them. Needed when programming Metrel SDK application. Run "DataDisplayFrameWorkVisualizer.exe" to start application.
docs	Example of Metrel SDK application. Run "Ion.Sdk.DemoApp.exe" to start application.
drivers	Documents with presentations and guides for Metrel SDK package.
libs	USB drivers for Metrel instruments.
source	Metrel SDK Contents libraries needed to be included in Visual studio project when programming application with Metrel SDK. File "cp_win.dll" (x86 or x64) should be added to final .exe file.
	Programming examples.

## ADDITIONAL INFO

Additional info regarding Metrel SDK can be also found on Metrel Knowledge Base internet site.

## LICENSES FOR METREL SDK

Metrel SDK is included in Metrel SDK zip package which is available from Metrel free of charge. However, SDK license is required for new generation of Metrel testers (listed below) for Upload and Download functionalities of Metrel SDK: MI 3152, MI 3152H, MI 3154, MI 3155, MI 3280, MI 3281, MI 3288, MI 3290, MI 3295, MI 3325, MI 3360, MI 3394, MI 6601.

The SDK is licensed in the same way as Metrel MESM PC SW and Metrel aMESM Android App. The SDK license is bound to a standard Metrel profile and serial number in the same way as any other Metrel licenses are.

## SUPPORTED INSTRUMENTS

Instrument	Support	Structure		Measurements		AutoSequence	
		Upload	Download	Upload	Download	Upload	Download
MI 3100 SE	Limited	•	•		•		
MI 3102 BT	Limited	•	•		•		
MI 3102H BT	Limited	•	•		•		
MI 3102H SE	Limited	•	•		•		
MI 3125 BT	Limited	•	•		•		
MI 3152	Full	•	•	•	•		•
MI 3152H	Full	•	•	•	•		•
MI 3154	Full	•	•	•	•		•
MI 3155	Full	•	•	•	•	•	•
MI 3280	Full	•	•	•	•	•	•
MI 3281	Full	•	•	•	•	•	•
MI 3288	Full	•	•	•	•	•	•
MI 3290	Full	•	•	•	•	•	•
MI 3295	Limited	•	•		•		
MI 3309 BT	Limited		•		•	•	
MI 3325	Full	•	•	•	•	•	•
MI 3360	Full	•	•	•	•	•	•
MI 3394	Full	•	•	•	•	•	•
MI 6601	Full	•	•	•	•	•	•

# Software

## SW 1403 Black Box protocol



The Black Box protocol is a system of rules that allows a PC (Personal Computer) as a master to start communication by sending the request command to the instrument, which answers according to the protocol.

Black Box protocol enables a two-way communication intended for controlling an instrument as a Black Box. This enables hands free operation as the control over the instrument is delegated to an automated system. Black Box protocol solution is primarily suitable for automatized production line testing, but has found its use in other applications such as portable appliance testing and in some cases also in electrical installation safety testing.

Black Box protocol can be used with terminal application such as Kitty (which is freely available from internet) and alike.

The Black Box protocol is also designed to be used with other PC software engineering tools such as Visual Basic and LabView, which, with some effort, can be used to perform remote communications between PC and test instrument.

Black Box protocol is supported in new generation of Metrel test instruments and is **free of charge**; no additional licenses are needed for using it.

Black Box protocol is also included in Metrel SDK; see Metrel SDK chapter for additional info.

### METREL INSTRUMENTS



### SOFTWARE USING BLACK BOX PROTOCOL

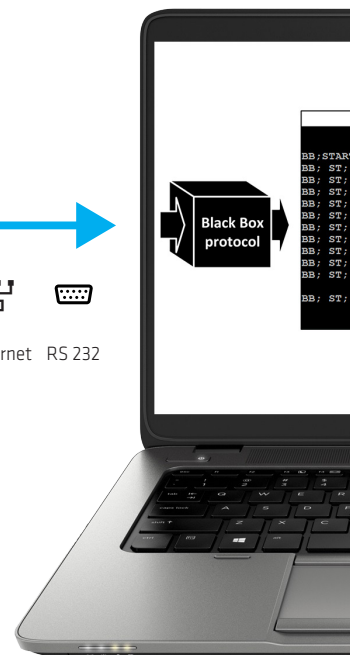

Black Box protocol in interaction with Metrel instruments

## SUPPORTED FUNCTIONALITIES OF BLACK BOX PROTOCOL

The Black Box protocol supports all measurement functionalities provided by the individual Metrel instrument; both Single Test and Auto Sequence measurements.

Black Box protocol supports all available communication with Metrel instruments: Ethernet, RS232, USB and Bluetooth.

The figure on the right shows example of comparison of measurement of Riso (Insulation resistance) via the Black Box protocol and directly on the instrument:

- to start measurement on instrument via the Black Box protocol, following command is entered, which also includes desired measurement parameters: "BB;START\_SINGLETEST 118; P4 = 500 V; P161 = Riso-S; P69 = 2 s",
- same measurement can be started directly on instrument by selecting corresponding measurement inside ISO measurements group of Single Tests menu.

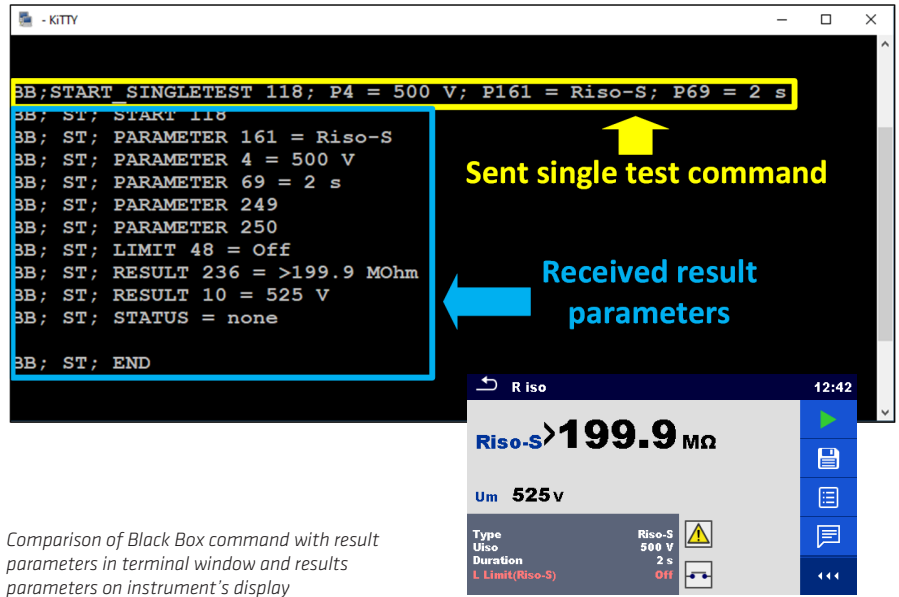

## BLACK BOX PROTOCOL USE CASE EXAMPLE

A simple example of using the Black Box protocol in a production line to test products with Metrel instruments is shown in the figure below. Such test setup can be fully automated and centrally controlled from a PC:

- two MI 3394 are used for products testing,
- first MI 3394 measures Continuity of each product from production line,
- second MI 3394 measures Riso (insulation resistance) of each product from production line,
- both MI 3394 are connected to PC via Ethernet,
- the PC runs software that uses the Black Box protocol to communicate with two MI 3394s.

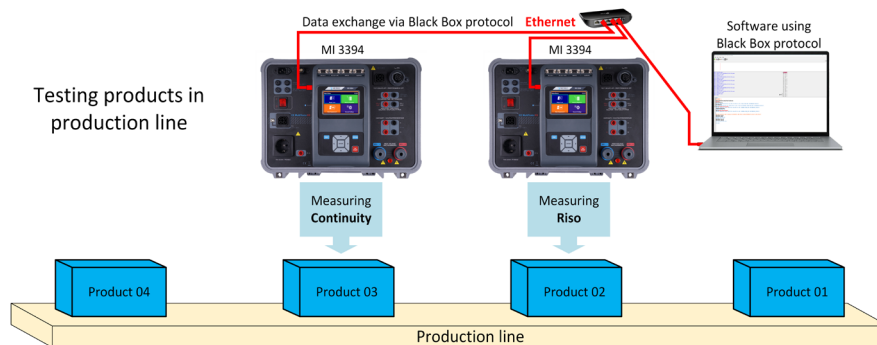

Product line testing using Black Box protocol for data exchange

## ADDITIONAL INFO

Additional info regarding Black Box protocol can be also found on Metrel Knowledge Base internet site.

## COMPATIBILITY

- Consult the Selection Guide for Software on page 7.2 for detailed information about compatibility with selected test and measurement instruments.

# Software

## SW 0802 PowerView3

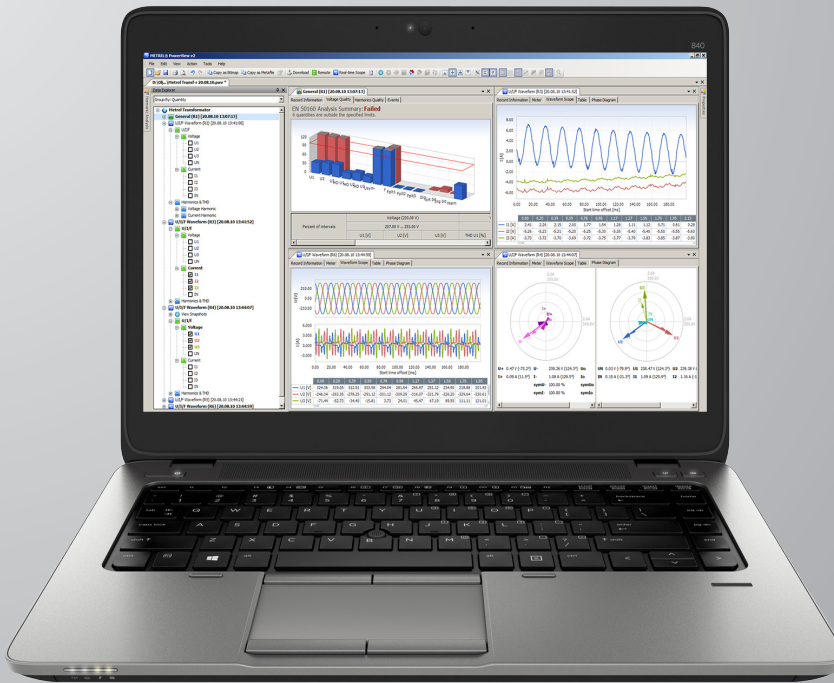

PowerView3 software is a powerful platform for downloading, analysing recorded data and creation of power quality test reports. PC Software contains a package of functionalities needed for profound evaluation of power quality phenomena, data comparison and creation of complex test reports. It works in conjunction with Metrel new generation power quality analysers. For the instruments equipped with GPRS functionality PowerView3 enables remote control of the instrument as well.

### KEY FEATURES

- **User friendly interface:** wide range of quick buttons, possibility to customize the environment by dragging, docking and resizing the window tabs.
- **Structure:** downloaded data is organized into Windows Explorer-like tree structure.
- **“Drag and drop”:** downloaded data can be easily organized into multiple sites and sub-site locations.
- **Data filtering:** data in a structure can be grouped by quantity or by phase.
- **Views:** depending on selected record type, different views are available (Record Information view, Trend Chart view, Table view, Waveform Scope view, Voltage Quality view, etc.)
- **EN 50160 analysis:** automatic voltage quality analysis in compliance with custom or predefined EN 50160 Power Quality criteria and quick report printing.
- **Chart zoom:** chart can be zoomed depending on selected in a table value range.
- **Remote control:** via GPRS communication remote handling of the instrument and its data can be executed.
- **GPS synchronization:** simultaneous measurement on the different network points by using 2 or more synchronized instruments.
- **On-line monitoring:** when instrument is connected with PC, real-time observing of signals and parameters is possible via PowerView3 while instrument is measuring / recording in the background.
- **Export of test results:** test results can be filtered and exported to other programs (MS Excel, MS Word, CSV, TXT).
- **Reports:** automatic generation of test reports from the selected views and data with attached graphs according specific standards/national specification, like: IEEE 519, GOST 32144/33073, Energy report, Energy demand report
- **SW update:** PowerView3 checks for new versions of the application and downloads updates from the Internet if necessary.

### COMPATIBILITY

- Consult the Selection Guide for Software on page 7.2 for detailed information about compatibility with selected test and measurement instruments.



Logged data can be analysed according to custom or predefined EN 50160 Power Quality criteria

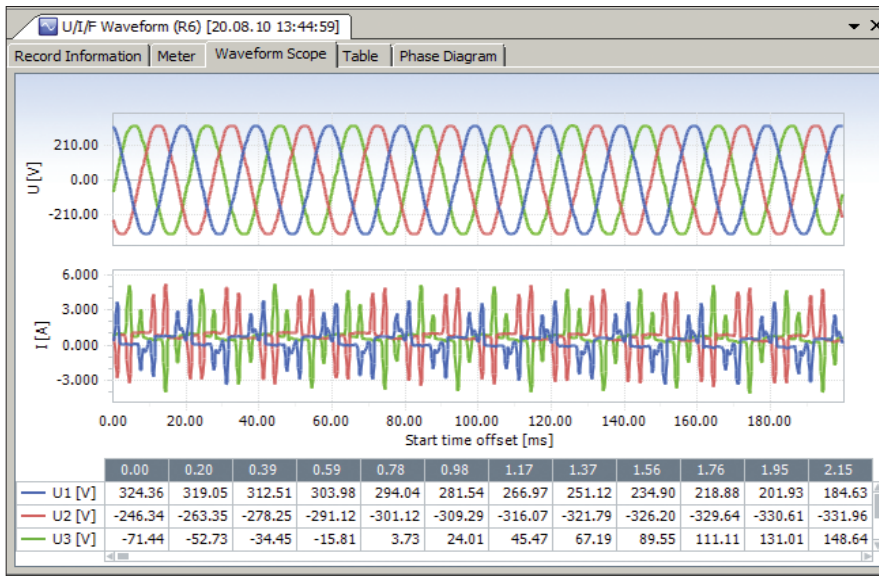
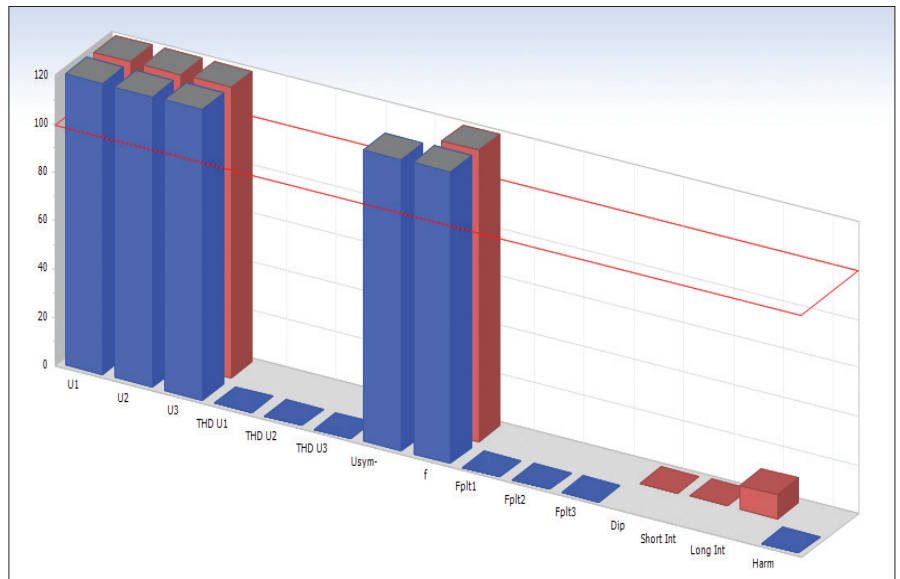
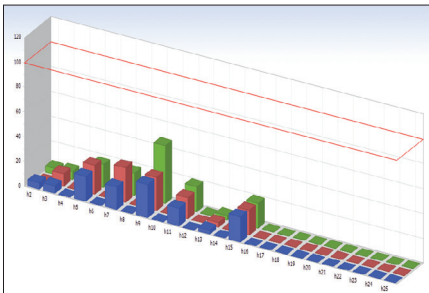

Results can be represented in both trend and table view simultaneously for easier analysis

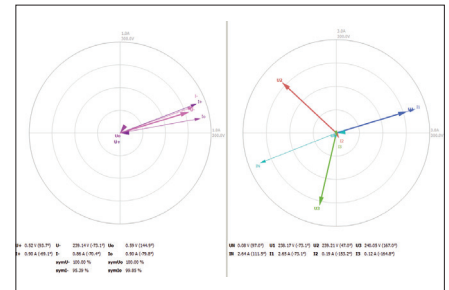

Selected data can be organized into multiple tabs for easier interpretation

Symbol	Name	L1	L2	L3	LN	Total	Unit
U	Voltage	238.20	239.25	240.08	0.0931	---	V
I	Current	3.6726	5.2318	3.4217	2.6520	---	A
f	Frequency	50.010	---	---	---	---	Hz
THD U	Voltage THD	1.4001	1.8151	1.5778	22.031	%	
THD I	Current THD	3.3346	4.3418	3.7876	0.0167	---	V
THD I	Current THD	0.1697	0.1193	0.0791	0.1553	---	A
P	Active Power	632.25	-43.60	25.395	---	614.04	W
Q	Reactive Power	-604.6	1,250.9	821.08	---	1,467.4	Var
S	Apparent Power	874.80	1,251.7	821.47	---	1,590.7	VA
U asym	Negative Sequence Voltage Ratio	---	---	---	---	100.00	%

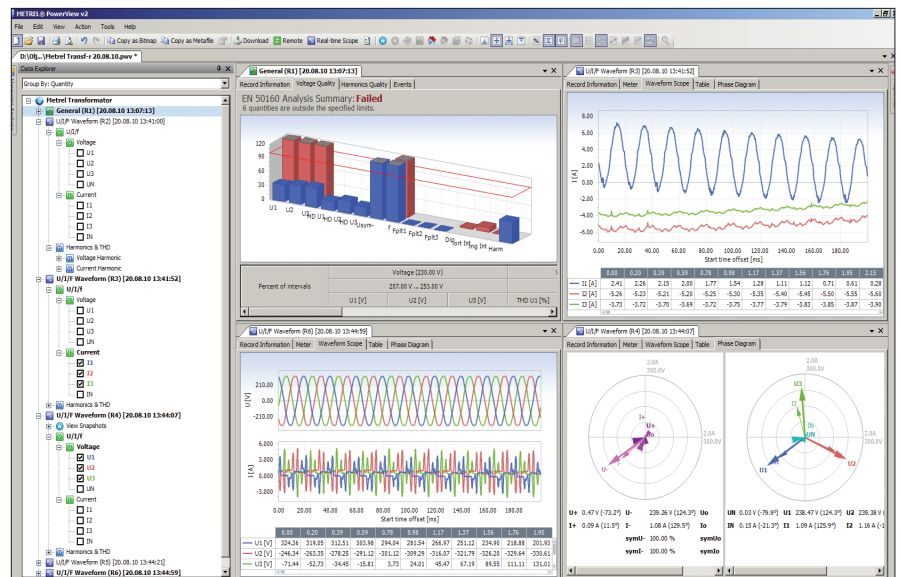

# Software

## SW 0201 PATLink PRO

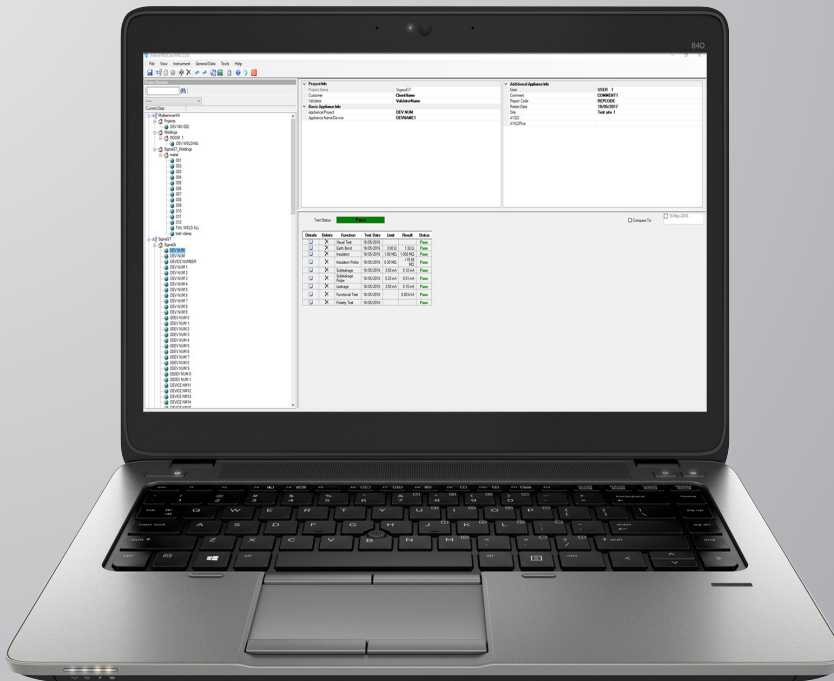

PC software PATLink PRO is an advanced, user friendly software package designed with the portable appliance testing engineer in mind. The graphical interface with drag and drop data relocation, data filtering, data archiving functions and automatic report generation allows a variety of users with a range of different skills and abilities to create professional reports which include company logos. The PATLink PRO Plus software introduces extra features including the ability to reload data onto Metrel uploadable / downloadable testers, perform trend analysis on equipment and introduces PRO Plus certificates and individual appliance reports.

### KEY FEATURES

- **Full data filtering:** All data can be filtered by different parameters: Retest Date, Test Date, Project, User, etc.
- **Tree style or table style:** Data can be represented in tree or table view.
- **Drag and drop:** The elements of the structure can be relocated and renamed.
- **Customer database:** It allows test engineer to create his own database of customers fully equipped with all appropriate data.
- **Company logo loading:** Load company logos into the software so that they can be printed on test reports.
- **Data backup:** All downloaded data can be backed up to prevent the loss of valuable data for example in case of hard disk failure.
- **Appliance information editing:** Allows you to edit data, e.g. to set up Retest Date, Repair Code, add Comments, etc.
- **Export of test results:** Data of selected appliances together with test results can be exported to other programs (MS Excel, MS Word).
- **PDF report:** Test Report can be transformed into PDF format.
- **Full built-in help files:** Integrated help menu contains detailed explanation of PC SW handling.
- **Automatic self-test record keeping:** Results of the CHECKBOX function (MI 3311 only) can be automatically transferred to the PC and printed onto the test reports.
- **“Plug & Play”:** When meter is connected to the PC it is automatically recognized by the software.
- **Upload data back to GT tester:** User can upload test results from the previous measurement session (e.g. from last year) so the same tests can be simply repeated and results of both measurements can be compared.
- **Autosequences upload:** Test autosequences can be prepared via PATLink PRO and then sent to the tester (MI 3309, MI 3311) for testing speedup.
- **Structures upload:** The structure of test site can be created in advance on the PC and then simply uploaded to the tester; if needed any deviations can be adjusted on the tester on site.
- **Trend analysis:** Enables to compare test results of the last and previous tests.
- **Automatic PRO report generation:** Enables automatic generation of Test Report (standard or full detailed).
- **PATLink PRO Plus professional reports:**

The PRO Plus report displays results as the PRO version but enables editing the information before printing the report.

### The following Certificates for PRO version are available:

- Full detailed PRO Electrical equipment test report;
- METREL PAT PRO Electrical equipment test report.

### The following Certificates for PRO Plus version are available:

- METREL PRO Plus (Single) Electrical equipment test report;
- METREL Full detailed PRO Electrical equipment test report;
- METREL PAT PRO Plus Electrical equipment test report.

### ORDERING INFORMATION

- **A 1305** PC SW PATLink PRO with USB and RS232-PS/2 cable

### COMPATIBILITY

- Consult the Selection Guide for Software on page 7.2 for detailed information about compatibility with selected test and measurement instruments.

# Software

## SW 0101 EuroLink PRO Plus

The EuroLink PRO / PRO Plus software works in conjunction with Metrel's downloadable installation testers. The software automatically finds the instrument and allows the test engineer to download test results saved on the instrument, review the results, relocate test results (if required), print test reports and print installation structures for storing in the distribution board. With the more advanced Metrel installation testers, structures can be built with the software and uploaded to the instrument for easy installation navigation while performing on-site testing. Additionally the EuroLink PRO Plus software offers the ability to automatically generate professional PRO Plus Reports.

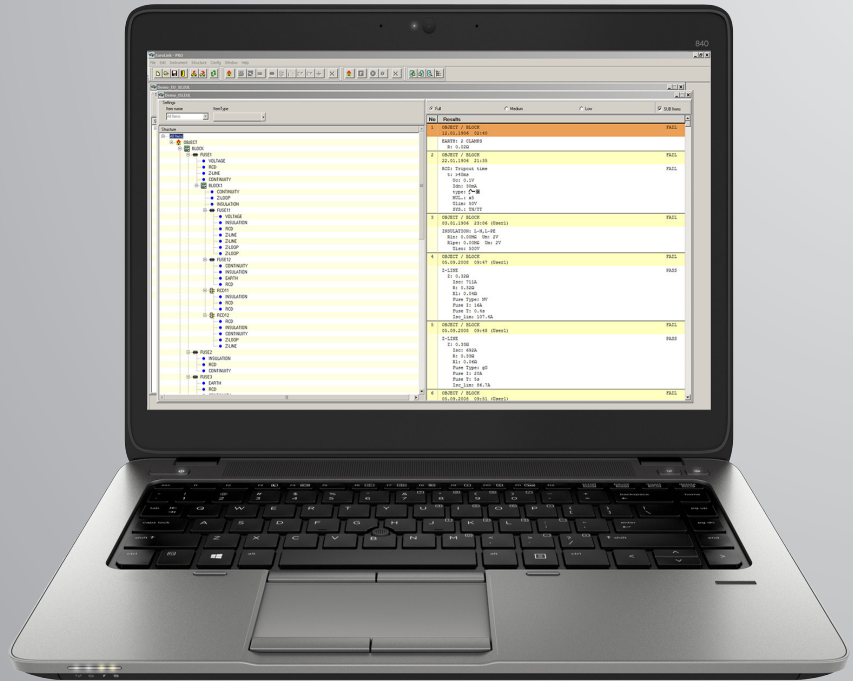

### KEY FEATURES

- **Automatic recognition of the instrument:** when connecting your instrument to the PC it is automatically recognized by the software.
- **Simple graphical visualisation of the installation structure:** enables graphical representation of the tested installation which makes it easy to navigate in the installation.
- **10-level structures:** in conjunction with MI 3105 and MI 3101 PC software enables creating the electrical installation structures with up to 10 levels and 4 levels for other models.
- **Rearranging of structures:** the elements of the structure can be relocated and renamed.
- **Installation structures printing:** structures can be printed and stored in the distribution board for easier later identification of the installation elements.
- **Structures upload:** the installation structure can be created in advance on the PC and then simply uploaded to your tester.

- **Export of test results:** test results in text format can be exported to other programs (MS Excel, MS Word).
- **Automatic PRO Test Report generation:** enables automatic generation of PRO Test Report (low, medium and high detailed).
- **Automatic PRO Plus Test Report generation (PRO Plus version only):** enables automatic generation of PRO Plus Test Report which include visual inspection of tested object and test results in tabular form.
- **Support of EuroLink Android:** supports extended file format from EuroLink Android app.

#### Key features of PRO Plus Test Reports:

- Downloaded test results are automatically inserted onto PRO Plus forms.
- Allows to fill out visual inspection form for tested fuse cabinet or earthing system.
- Automatically selects worst case test results for form completion.
- Easy test report generation and reviewing facilities.

#### EuroLink PRO Plus enables creation of the following test reports:

- PRO Plus Test Report
- NICEIC certificates (UK)
- ZVEH certificates (Germany)
- SiNa certificates (Switzerland)
- ÖVE certificates (Austria)
- HD 384 certificates (Greek)
- KEHE certificates (Greek)
- GOST R 50571 (Russia)
- UNE - 202008 certificates (Spain)

### ORDERING INFORMATION

- **A 1291** PC SW EuroLink PRO with USB and RS232-PS/2 cable
- **A 1290** PC SW EuroLink PRO Plus with USB and RS232-PS/2 cable
- **A 1292** Upgrade code EuroLink PRO to EuroLink PRO Plus

### COMPATIBILITY

- Consult the Selection Guide for Software on page 7.2 for detailed information about compatibility with selected test and measurement instruments.

# Software

## SW 0113 HVLink PRO

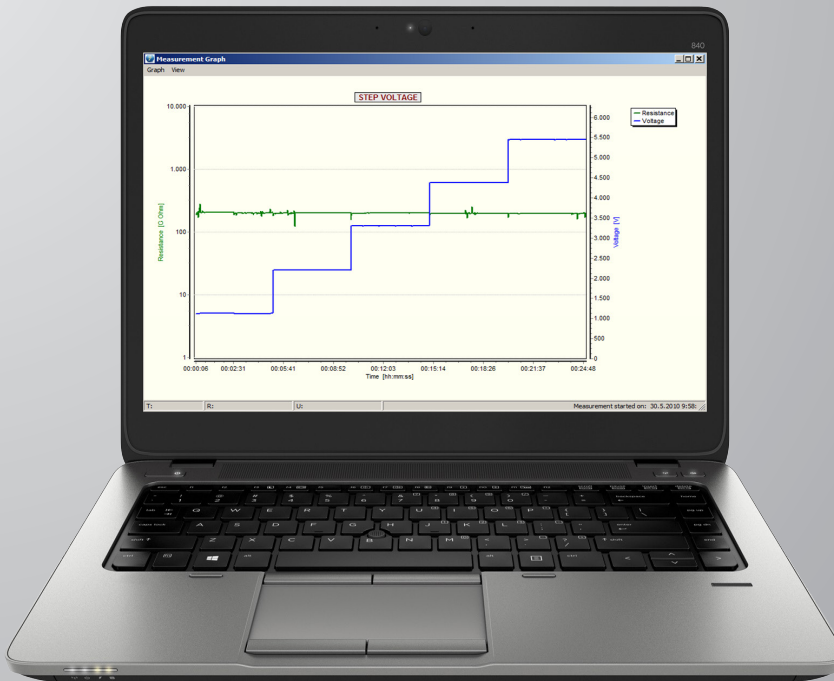

The HVLink PRO software works in conjunction with Metrel newest HV insulation testers, Step Contact Voltage Measuring System and MicroOhms. The software automatically recognizes connected instrument and allows the customer to download test results saved on the instrument, review the results, rename and relocate data if needed and print test reports.

### KEY FEATURES

- **Automatic recognition of the instrument:** when connecting your instrument to the PC it is automatically recognized by the software.
- **Tree view:** all the results are represented in tree view for easy data management.
- **Rearranging of structures:** the elements of the tree structure can be relocated and renamed.
- **R(t) graphs:** if graph R(t) was enabled when testing with the instrument MI 3201 then it can be plotted and printed with the software.
- **Measurement tables:** if graph R(t) was enabled when testing with the instrument MI 3201 then a table with fixed R(t) values can be viewed and printed.
- **Export of test results:** test results in text format can be exported to other programs (MS Excel, MS Word).
- **Automatic Test Report generation:** enables automatic generation of Test Report (low, medium and high detailed).

### ORDERING INFORMATION

- **A 1275** PC SW HVLink PRO with USB and RS232-PS/2 cable

### COMPATIBILITY

- Consult the Selection Guide for Software on page 7.2 for detailed information about compatibility with selected test and measurement instruments.

# Software

## SW 1304 aMESM Android

The aMESM is an advanced electrical installation safety Testing tool for Android devices. It enables fast and simple data management of tested installations, as well as a quick overview of already performed tests. The Application enables the user to send results to the office before leaving the test site and enter and save data to the test instrument by using the smart phones' keyboard. It enables creation of customer and test location database as well as adding text and pictures, videos or voice records to the specific position in the test structure. All these features enable the user faster and easier data handling.

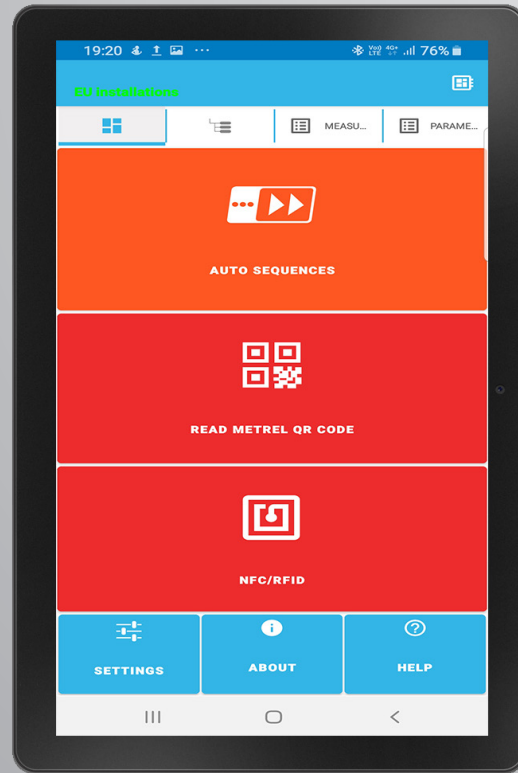

### KEY FEATURES

- Complete database of tested installations in one location;
- Easy data entering;
- Projects can be stored to your drop box account;
- Sending data to the main office before leaving the test site;
- Overview of testing parameters;
- Adding text, picture, video or voice records to test results;
- Creation of customer and test location database.
- Creation of a simple PDF test report.
- Remote starting of tests on MI 3143 Euro Z 440 V and MI 3144 Euro Z 800 V.

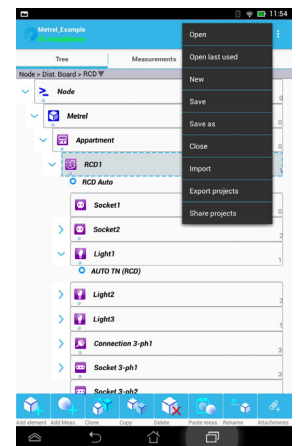
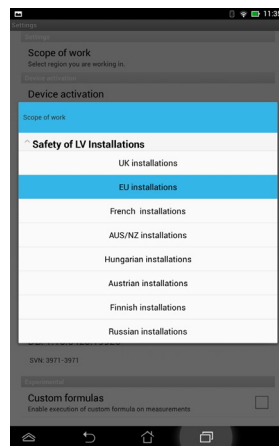

### COMPATIBILITY

- Consult the Selection Guide for Software on page 7.2 for detailed information about compatibility with selected test and measurement instruments.

# Software

## SW 1303 aPAT Android

Android

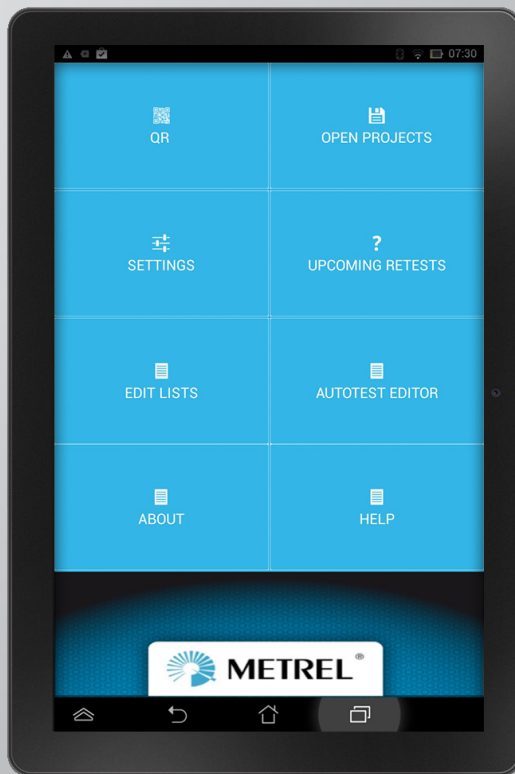

The aPATLink Android is Advanced Portable Appliance Testing tool. It enables fast and simple data management of tested appliances, as well as a quick overview of already performed tests by simply scanning a QR code. The application enables the user to send results to the main office before leaving test site, enter and save data to the test instrument by using a Smart phones' keyboard. Also it enables a creation of the custom made database for portable appliances' ID's, the appliances' names and the appliances' locations. All these features enable the user a faster and easier data handling.

### KEY FEATURES

- Complete database of tested appliances on one location;
- Upcoming retest warning on your smart phone or tablet;
- Simple, custom auto-test creation;
- Use of smart phones barcode or QR code scanner for quicker data entry;
- Remote control of GT tester;
- Easy data entering;
- Projects can be stored to your drop box account;
- Sending data to main office, before leaving test site;
- Built in risk assessment calculator;
- None skilled user can perform test simply by scanning the QR code containing all needed information for specific appliance;
- Overview of testing parameters by simple scanning QR code.

### ADDITIONAL FEATURES

- In Built Risk Assessment tool to provide correct Re-Test periods in accordance with COP version 4;
- Protect your business by applying QR codes instead of Bar Codes.

### COMPATIBILITY

- Consult the Selection Guide for Software on page 7.2 for detailed information about compatibility with selected test and measurement instruments.

# Software

## SW 1306 EuroLinkPV Android

The EuroLinkPV Android is a data management tool for android tablets and smart phones. It is used at the site of testing together with Metrel's Photovoltaic testers as a measurement pre- and post-processing tool. It enables the wireless communication between instrument and Android device. With this application testing of PV is more comfortable and effective.

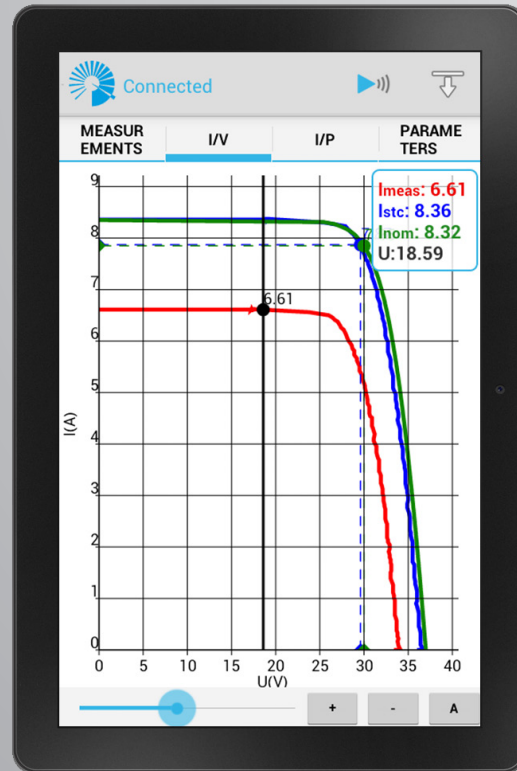

### KEY FEATURES

- View the results of the I/V measurement in graphical or numerical form.
- Compare the results with the nominal values and characteristic.
- Edit the module data stored in instrument memory using the Android Keyboard.
- Edit the module list stored in instrument memory.

- The module data can be selected from the huge module Data Base delivered within the EuroLinkPV Android application.
- It supports Bluetooth dongle enabling a communication channel between the below listed measuring instruments and a smart phone or a tablet with Android OS and installed application EuroLinkPV Android.

### COMPATIBILITY

- Consult the Selection Guide for Software on page 7.2 for detailed information about compatibility with selected test and measurement instruments.

# Software

## SW 1308 PATLink Android

Android

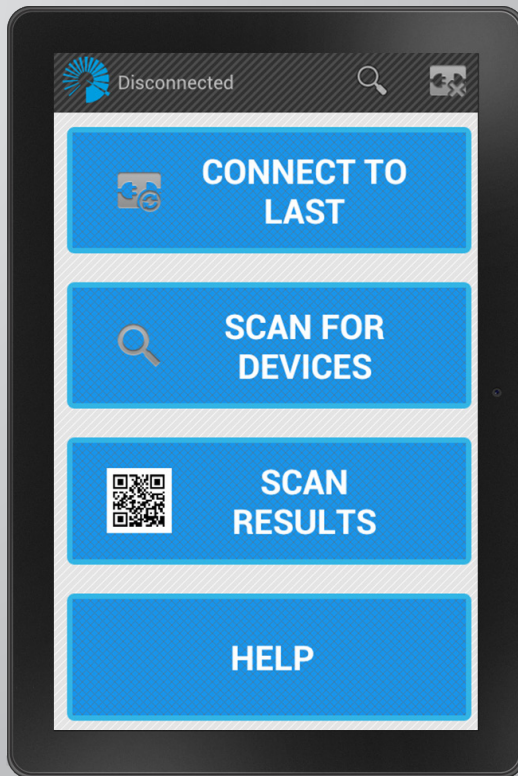

The PATLink Android is a powerful tool. It enables fast and simple data management of tested appliances, as well as a quick overview of already performed tests by simply scanning a QR code. The application enables the user to enter and save data to the test instrument by using a Smart phones' keyboard. Also it enables a creation of the custom made database for portable appliances' ID's, the appliances' names and the appliances' locations. All these features enable the user a faster and easier data handling. PATLink Android enables the user to scan the QR codes which contain information of the previous results, the test status, and the previously used test sequence. Based on this information the user can start the retest of the appliance with a single press on the Android application.

### KEY FEATURES

- On - site comparison of the test results;
- Creation of the custom database;
- Use of Smart phones camera for the QR and Barcode scanning;
- Use of Smart Phones virtual keyboard.

### ADDITIONAL FEATURES

- In Built Risk Assessment tool to provide correct Re-Test periods in accordance with COP version 4;
- Protect your business by applying QR codes instead of Bar Codes.

### COMPATIBILITY

- Consult the Selection Guide for Software on page 7.2 for detailed information about compatibility with selected test and measurement instruments.



# Software

## SW 1307 EuroLink Android

The EuroLink Android is a data management tool for android tablets and smart phones. It is used in the field together with Metrel's Electrical Installation Safety testers to serve as a measurement pre- and post-processing tool. It also enables the wireless communication between instrument and Android device on one side and bunch of wireless communication methods between Android device and PC.

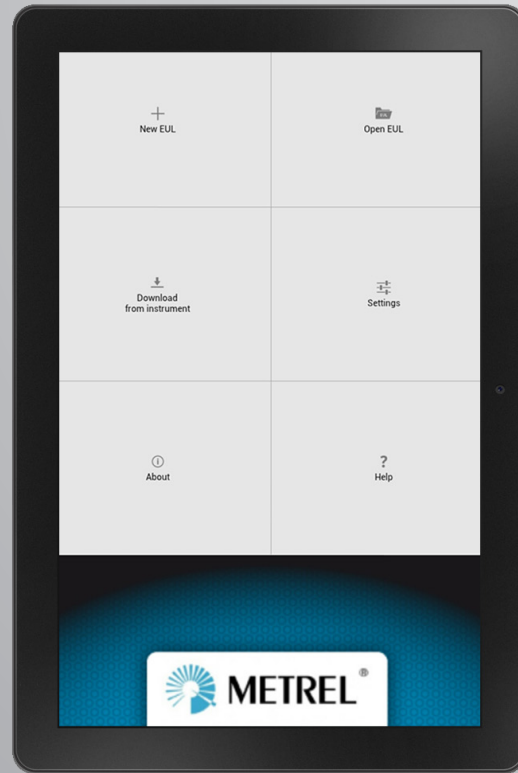

### KEY FEATURES

- Attach notes, Photographs, Audio or Video Files!
- Create Structure of Electrical Installation at the site.
- Upload Structure of Electrical Installation to your test instrument
- Download measurement results to EuroLink Android application.

- Transfer Data, Share files or Send them through your Tablet or Smart Phone Tools to your Office for further manipulation.
- It is compatible with EuroLink PRO and EuroLinkPRO Plus PC SW.
- It supports Bluetooth dongle or built-in BT enabling communication channel between the below listed measuring instruments and a smart phone or a tablet with Android OS and installed application EuroLink Android.

### COMPATIBILITY

- Consult the Selection Guide for Software on page 7.2 for detailed information about compatibility with selected test and measurement instruments.





METREL d.o.o.  
Test and Measurement Equipment  
Ljubljanska 77, SI-1354 Horjul, Slovenia  
T +386 (0)1 75 58 200  
info@metrel.si  
www.metrel.si

Distributor:

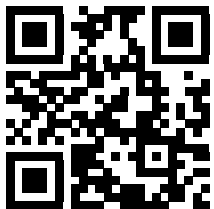

Note! Photographs in this catalogue may slightly differ from the instruments at the time of delivery.  
Subject to technical change without notice.

GENERAL\_2023\_Ang\_April